

# AURA / PRIME SD

## OWNER'S MANUAL

Operation  
Maintenance  
Specifications

All information in this Owner's Manual is current at the time of publication. However, HYUNDAI reserves the right to make changes at any time without prior notice and without obligation to incorporate such changes so that our policy of continual product improvement may be carried out.

This manual applies to all models of this vehicle and includes descriptions and explanations of optional as well as standard equipment. As a result, you may find material in this manual that does not apply to your specific vehicle.

## CAUTION: MODIFICATIONS TO YOUR HYUNDAI

Your HYUNDAI should not be modified in any way. Such modifications may adversely affect the performance, safety or durability of your HYUNDAI and may, in addition, violate conditions of the limited warranties covering the vehicle. Certain modifications may also be in violation of regulations established by the Department of Transportation and other government agencies in your country.

## TWO-WAY RADIO OR CELLULAR TELEPHONE INSTALLATION

Your vehicle is equipped with electronic fuel injection and other electronic components. It is possible for an improperly installed/adjusted two-way radio or cellular telephone to adversely affect electronic systems. For this reason, we recommend that you carefully follow the radio manufacturer's instructions or consult your HYUNDAI dealer for precautionary measures or special instructions if you choose to install one of these devices.

## SAFETY AND VEHICLE DAMAGE WARNING

This manual includes information titled as DANGER, WARNING, CAUTION and NOTICE.

These titles indicate the following:



### DANGER

DANGER indicates a hazardous situation which, if not avoided, will result in death or serious injury.



### WARNING

WARNING indicates a hazardous situation which, if not avoided, could result in death or serious injury.



### CAUTION

CAUTION indicates a hazardous situation which, if not avoided, could result in minor or moderate injury.

### NOTICE

NOTICE indicates a situation which, if not avoided, could result in vehicle damage.

# Table of Contents

Hyundai Warranty Policy	1
Vehicle Information	2
Safety System	3
Instrument Cluster	4
Convenience Features	5
Driving Your Vehicle	6
Driver Assistance System	7
Emergency Situations	8
Maintenance	9

---

## FOREWORD

Thank you for choosing HYUNDAI. We are pleased to welcome you to the growing number of discriminating people who drive HYUNDAI. The advanced engineering and high-quality construction of each HYUNDAI we build is something of which we're very proud.

Your Owner's Manual will introduce you to the features and operation of your new HYUNDAI. It is suggested that you read it carefully because the information it contains can contribute greatly to the satisfaction you receive from your new car.

The manufacturer also recommends that service and maintenance on your vehicle be performed by an authorized HYUNDAI dealer.

## HYUNDAI MOTOR COMPANY

The QR code affixed to your vehicle is intended to provide direct and exclusive access to the digital version of the Owner's manual. The said QR code shall be deemed to form an integral and permanent component of the vehicle.

It is advised to download and securely retain a copy of the Owner's manual within myHyundai App for reference and use as may be required.

Any tempering, removal, defacement, or alteration of the QR code sticker affixed to the vehicle is strictly discouraged, as the same may impede or restrict access to important vehicle related information made available by the manufacturer through this QR code.



### CAUTION

**Severe engine and transmission damage may result from the use of poor quality fuels and lubricants that do not meet HYUNDAI specifications. You must always use high quality fuels and lubricants that meet the specifications listed on Page 2-10 in the Vehicle Specifications section of the Owner's Manual.**

Copyright 2024 HYUNDAI Motor Company. All rights reserved. No part of this publication may be reproduced, stored in any retrieval system or transmitted in any form or by any means without the prior written permission of HYUNDAI Motor Company.

---

## FUEL REQUIREMENTS

### Petrol engine

#### *Unleaded*

Your new vehicle is designed to perform optimally using unleaded fuel having an Octane Rating of RON (Research Octane Number) 91 / AKI (Anti-Knock Index) 87 or higher. (Do not use methanol blended fuels)

Your new vehicle is designed to obtain maximum performance with UNLEADED FUEL, as well as minimize exhaust emissions and spark plug fouling.

#### **NOTICE**

**NEVER USE LEADED FUEL.** The use of leaded fuel is detrimental to the catalytic converter and will damage the engine control system's oxygen sensor and affect emission control.

Also, severe wear and crack of piston ring, valve, etc. may occur and knocking noise may be heard from your engine.

Never add any fuel system cleaning agents to the fuel tank other than what has been specified (We recommend that you consult an authorized HYUNDAI dealers for details.)



#### **WARNING**

- Do not "top off" after the nozzle automatically shuts off when refueling.
- Always check that the fuel cap is installed securely to prevent fuel spillage in the event of an accident.

### ***Petrol containing alcohol and methanol***

Gasohol, a mixture of petrol and ethanol (also known as grain alcohol), and petrol or gasohol containing methanol (also known as wood alcohol) are being marketed along with or instead of leaded or unleaded petrol.

Do not use gasohol containing more than 20% ethanol, and do not use petrol or gasohol containing any methanol. Either of these fuels may cause drivability problems and damage to the fuel system, engine control system and emission control system.

Discontinue using gasohol of any kind if drivability problems occur.

Vehicle damage or drivability problems may not be covered by the manufacturer's warranty if they result from the use of:

1. Gasohol containing more than 20% ethanol.
2. Petrol or gasohol containing methanol.
3. Leaded fuel or leaded gasohol.



### **CAUTION**

**Never use gasohol which contains methanol. Discontinue use of any gasohol product which impairs drivability.**

### ***Using Fuel Additives***

Using fuel additives such as:

- Silicone fuel additive
- MMT (Manganese, Mn) fuel additive
- Ferrocene (iron-based) fuel additive
- Other metallic-based fuel additives

May result in cylinder misfire, poor acceleration, engine stalling, engine plugging, heavy knocking noise, damage to the catalyst, or abnormal corrosion, and may cause damage to the engine resulting in a reduction in the overall life of the powertrain. The Malfunction Indicator Lamp (MIL) may illuminate.

### **NOTICE**

**Damage to the fuel system or performance problem caused by the use of these fuels may not be covered by your New Vehicle Limited Warranty.**

---

### ***Use of MTBE***

HYUNDAI recommends avoiding fuels containing MTBE (Methyl Tertiary Butyl Ether) over 15.0% vol. (Oxygen Content 2.7% weight) in your vehicle.

Fuel containing MTBE over 15.0% vol. (Oxygen Content 2.7% weight) may reduce vehicle performance and produce vapor lock or hard starting.



### **CAUTION**

**Your New Vehicle Limited Warranty may not cover damage to the fuel system and any performance problems that are caused by the use of fuels containing methanol or fuels containing MTBE (Methyl Tertiary Butyl Ether) over 15.0% vol. (Oxygen Content 2.7% weight.)**

### ***Do not use methanol***

Fuels containing methanol (wood alcohol) should not be used in your vehicle. This type of fuel can reduce vehicle performance and damage components of the fuel system, engine control system and emission control system.

### ***Fuel Additives***

HYUNDAI recommends that you use unleaded petrol which has an Octane Rating of RON (Research Octane Number) 91 / AKI (Anti-Knock Index) 87 or higher.

For customers who do not use good quality petrols including fuel additives regularly, and have problems starting or the engine does not run smoothly, one bottle of additives added to the fuel tank at every 10,000 km.

Additives are available from your authorized HYUNDAI dealer along with information on how to use them. Do not mix other additives.

### ***Operation in foreign countries***

If you are going to drive your vehicle in another country, be sure to:

- Observe all regulations regarding registration and insurance.
- Determine that acceptable fuel is available.

---

## VEHICLE MODIFICATIONS

This vehicle should not be modified. Modification of your vehicle could affect its performance, safety or durability and may even violate governmental safety and emissions regulations.

- In addition, damage or performance problems resulting from any modification may not be covered under warranty.
- If you use unauthorized electronic devices, it may cause the vehicle to operate abnormally, wire damage, battery discharge and fire. For your safety, do not use unauthorized electronic devices.



---

## VEHICLE BREAK-IN PROCESS

No special break-in period is needed. By following a few simple precautions for the first 1,000 km (600 miles), you may add to the performance, economy and life of your vehicle:

- Do not race the engine.
- While driving, avoid sudden acceleration.
- Do not maintain a single speed for long periods of time, either fast or slow. Varying the engine speed is needed to properly break-in the engine.
- Avoid hard stops, except in emergencies, to allow the brakes to seat properly.
- Fuel economy and engine performance may vary depending on vehicle break-in process and be stabilized after 6,000 km (4,000 miles). New engines may consume more oil during the vehicle break-in period.



# 1. Hyundai Warranty Policy

---

Hyundai New Vehicle Warranty .....	1-2
Replacement Parts Warranty .....	1-3
Hyundai Extended Warranty .....	1-5
Labour Free Service of Vehicle .....	1-5
Hyundai Road Side Assistance .....	1-6
Labour Free Service Coupons.....	1-7

## HYUNDAI NEW VEHICLE WARRANTY

Hyundai Motor India Limited herein after called "HMIL", warrants that each new Hyundai vehicle sold shall be free from any defects in material and workmanship, under normal use and maintenance, subject to the following terms and conditions.

### 1. Warranty Period

This warranty for hyundai vehicle shall exist for a period of 36 months/ 100,000 Kms from the date of delivery which soever is earlier to the first purchaser. This warranty is transferable to subsequent owner for the remaining warranty period. This warranty is applicable only in India and not transferable to any other country.

### 2. What is covered

Except as provided in paragraph 3 hereof, our Authorized Dealers shall either repair or replace, any Hyundai genuine part that is acknowledged by HMIL to be defective in material or workmanship within the warranty period stipulated above, at no cost to the owner of the Hyundai vehicle for parts or labour. Such defective parts which have been replaced will become the property of HMIL

### 3. What is not covered

*This warranty shall not apply to:*

- ▶ Normal maintenance services other than the three labour free services, including without lim-

itation, cleaning and polishing, minor adjustments, engine tuning, oil/fluid changes, filters replenishment, fastener retightening, wheel balancing, wheel alignment and tyre rotation etc.

- ▶ Replacement of parts as a result of normal wear and tear such as spark plugs, belts, brake pads and linings, clutch disc/facing, filters, wiper blades, bulbs, fuses, etc.

#### *Damage or failure resulting from :*

- ▶ Negligence of proper maintenance as required in this Owner's Manual and Service Booklet.
- ▶ Misuse, abuse, accident, theft, flooding or fire.
- ▶ Use of improper or insufficient fuel, fluids or lubricants.
- ▶ Use of parts other than Hyundai Genuine Parts.
- ▶ Any device and/or accessories not supplied by HMIL.
- ▶ Modifications, alterations, tampering or improper repair.
- ▶ Parts used in applications of which they were not designed or not approved by HMIL.
- ▶ Slight irregularities not recognised as affecting quality or function of the vehicle or parts, such as slight noise or vibrations, or items considered characteristic of the vehicle.
- ▶ Airborne "fallout", Industrial fallout, acid rain, hail and windstorms, or other Acts of God.
- ▶ Paint scratches, dents or similar paint or body damage.
- ▶ Action of road elements (sand, gravel, dust or road debris) which results in stone chipping of paint

or glass.

- ▶ Incidental or consequential damages, including without limitation, loss of time, inconvenience, loss of use of vehicle or commercial loss.
- ▶ This warranty is the entire warranty given by HMIL for Hyundai vehicles and no dealer or its or his agent or employee is authorized to extend or enlarge this warranty

Wireless Charger, Batteries, Tyres & Tubes, and originally equipped on Hyundai vehicles are warranted directly by the respective manufacturers and not by HMIL.

and no dealer or its or his agent or employee is authorized to make any oral warranty on HMIL's behalf.

- ▶ HMIL reserves the right to make any change in design or make any improvement on the vehicle at any time without any obligation to make the same change on vehicles previously sold.
- ▶ HMIL reserves the right for the final decision in all warranty matters.

### **Owner's Responsibilities**

- ▶ Proper use, maintenance and care of vehicle in accordance with the instructions contained in this Owner's Manual and Service Booklet. If the vehicle is subject to severe usage conditions, such as operation in extremely dusty, rough, more repeated short distance driving or heavy city traffic during hot weather, maintenance of vehicle should be done more frequently as men-

tioned in this Owner's Manual and Service Booklet

- ▶ Retention of maintenance service records. It may be necessary for the customer to show that the required maintenance has been performed, as specified in this Owner's Manual and Service Booklet.
- ▶ Delivery of the vehicle during regular service business hours to any authorized Hyundai Dealer to obtain warranty service.
- ▶ In order to maintain the validity of this Basic Warranty, the vehicle must be serviced by Hyundai Authorized workshop in accordance to the Owner's Manual and Service Booklet.

## **PARTS REPLACEMENT WARRANTY**

Hyundai Motor India Limited hereinafter called "HMIL", warrants that each new Hyundai Genuine replacement part purchased from and installed by Hyundai Authorized Dealer shall be free from any defects in material or workmanship, under normal use and maintenance, subject to the following terms and conditions

### **1. Warranty period**

This warranty shall exist for a period of 6 months or until the vehicle has been driven for a distance of 10,000 Kilometers from the date of installation of replacement part by Hyundai Authorized Dealer, whichever occurs first.

## 2. What is covered

Our Authorized Dealers shall either repair or replace, any Hyundai genuine part listed in paragraph 3 hereof, that is acknowledged by HMIL to be defective in material or workmanship within the warranty period stipulated above, after examinations carried out to confirm that none of the original settings have been tampered with, at no cost to the owner of the Hyundai vehicle for parts or labour. Such defective parts which have been replaced will become the property of HMIL

## 3. What is not covered

This warranty shall not apply to:

- Normal maintenance services of parts such as cleaning, adjustment or replacement (i.e. spark plugs that are oil fouled, lead fouled, or which fail due to the use of low grade fuel).
- Parts that fail due to abuse, misuse, neglect, alteration or accident or which have been improperly lubricated or repaired
- Parts used in applications for which they were not designed or approved by HMIL.
- Failure due to normal wear of parts.
- Direct or indirect failures caused by misuse and improper maintenance of vehicle.
- Any vehicle on which the odometer reading has been altered so that mileage cannot be accurately determined.

- Incidental or consequential damages, including without limitation, loss of time, inconvenience, loss of use of vehicle or commercial loss.

This warranty is the entire warranty given by HMIL for Hyundai replacement parts and no dealer or its or his agent or employee is authorized to extend or enlarge this warranty and no dealer or its or his agent or employee is authorized to make any oral warranty on HMIL's behalf. HMIL reserves the right for the final decision in all warranty matters.

### Owner's Responsibility :

- Proper use, maintenance and care of the vehicle in accordance with the instructions contained in the Owner's Manual and Service Booklet.
- Retention of maintenance service records. It may be necessary for the customer to show that the required maintenance has been performed, as specified in this Owner's Manual and Service Booklet.
- **Retention of the customer's copy of the original repair order and its invoice/bill against which the part was replaced.**
- Delivery of the vehicle during regular service business hours to the same Hyundai Authorized Dealer who had sold and installed the replacement part
- In order to maintain the validity of this Parts replacement Warranty, the vehicle must be serviced by Hyundai Authorized workshop in accordance to the Owner's Manual and Service Booklet.

**HYUNDAI EXTENDED WARRANTY\***

HMIL offers optional paid extended warranty on selected models, in addition to the basic new vehicle warranty. For more details on Hyundai Extended Warranty please call the nearest dealer or our toll free number 1-800-11-4645.

*\*Conditions apply*

**Labour Free Service of Vehicle**

Your vehicle is entitled for first three labour free services of Periodic Maintenance Schedule (PMS). Please refer page 2-7 for labour free service coupons and page 2-8 for PMS services.

**NOTICE:**

All Consumables, Wheel Alignment and / or Part Replacement (if not covered in warranty), if required are chargeable to the customer(s).

We are pleased to introduce you to our 24 X 7 Hyundai Road Side Assistance Programme

**Our Road Side Assistance number is : 1800 102 4645 (toll free)**

Hyundai Roadside assistance is a 24 X 7 emergency support provided in the event of any mechanical/electrical breakdown and/or road traffic accident of a vehicle.

#### Covered Events & Benefits\*

**Break Down/Accident**

Roadside repair or vehicle recovery in case of breakdown/road traffic accident

**Tire Related**

Tire Puncture – Replacement of punctured tire with the spare tire

**Battery Related**

Dead Battery – Jump start

**Key Related**

Locked keys, lost keys or broken vehicle keys

**Fuel Related Support**

Out of fuel, incorrect or contaminated fuel

\* Terms and Conditions apply.

#### Terms and Conditions

- 1) The Service is applicable for 3 years from the date of sale.
- 2) The 24 X 7 Road Side Assistance is available up to a nearest Hyundai Authorised dealer workshop.
- 3) The Service is applicable for a condition in which the vehicle has been immobile.
- 4) Cost of parts replacement is not included, unless covered under Hyundai Warranty.
- 5) Cost of repairs made to your vehicle is not included, unless it is covered under Hyundai Warranty.
- 6) For Online retail RSA & Complete TnC's, kindly visit: <https://hyundai.awpassistance.in/>



**1<sup>st</sup> Labour Free Service  
Coupon**

(1,200-1,500 km or within 2 months of  
delivery, whichever is earlier)

**Customer Copy**

Model Name \_\_\_\_\_  
Customer's Name \_\_\_\_\_  
VIN \_\_\_\_\_  
Registration No. \_\_\_\_\_  
Mileage \_\_\_\_\_  
Delivery Date \_\_\_\_\_  
Service Date \_\_\_\_\_  
RO Number \_\_\_\_\_  
Dealer/HASC code \_\_\_\_\_

**Servicing Dealer's Stamp**

Service Mgr's Signature \_\_\_\_\_

**2<sup>nd</sup> Labour Free Service  
Coupon**

(9,000-10,000 km or within 12 months of  
delivery whichever is earlier)

**Customer Copy**

Model Name \_\_\_\_\_  
Customer's Name \_\_\_\_\_  
VIN \_\_\_\_\_  
Registration No. \_\_\_\_\_  
Mileage \_\_\_\_\_  
Delivery Date \_\_\_\_\_  
Service Date \_\_\_\_\_  
RO Number \_\_\_\_\_  
Dealer/HASC code \_\_\_\_\_

**Servicing Dealer's Stamp**

Service Mgr's Signature \_\_\_\_\_

**3<sup>rd</sup> Labour Free Service  
Coupon**

(19,000-20,000 km or within 24 months of  
delivery whichever is earlier)

**Customer Copy**

Model Name \_\_\_\_\_  
Customer's Name \_\_\_\_\_  
VIN \_\_\_\_\_  
Registration No. \_\_\_\_\_  
Mileage \_\_\_\_\_  
Delivery Date \_\_\_\_\_  
Service Date \_\_\_\_\_  
RO Number \_\_\_\_\_  
Dealer/HASC code \_\_\_\_\_

**Servicing Dealer's Stamp**

Service Mgr's Signature \_\_\_\_\_

**CHECK LIST FOR LABOUR FREE SERVICE 1500 KM - 20,000 KM**

**A-ADD I-INSPECT C-CLEAN R-REPLACE L-LUBRICATE I(IR)-INSPECT IF REQUIRED**

(AFTER INSPECTION, ADD, REPAIR OR REPLACE IF NECESSARY)

No.	Item Description	1st Service		2nd Service		3rd Service	
		Reqd.	Done	Reqd.	Done	Reqd.	Done
<b>A. ENGINE BAY</b>							
1	Engine oil & filter*	I		R		R	
2	Engine Timing Chain / belt	-		-		-	
3	Air cleaner filter (Petrol only)*	-		C		C	
4	Air cleaner Filter (Diesel only)*	-		C		R	
5	Battery condition & specific gravity	I		I		I	
6	Throttle body (Petrol only)	-		-		-	
7	Spark plugs (Petrol only)	-		C		C	
8	Valve clearance	I(IR)		I(IR)		I(IR)	
9	Hoses (Vacuum/ EGR/ VGT/ WGT)	-		I		I	
10	Crankcase ventilation hose	I		I		I	
11	Tensioner/idler/damper pulley	I(IR)		I(IR)		I(IR)	
12	Power steering fluid and leakages**	-		-		-	
13	Brake/Clutch fluid	I		I		I	
14	Engine coolant	I		I		I	
15	Manual transaxle fluid	-		-		-	
16	Automatic transaxle fluid**	-		-		-	
<b>B. VEHICLE ON FLOOR</b>							
17	Wiper (wiper blade, washer fluid)	I		I		I	
18	Brake/Clutch (free play & leakages)	I		I		I	
19	Fuel filler cap	-		I		I	
20	Climate control air filter*	I		C		R	
21	Check AC system (refrigerant/compressor)	I		I		I	
22	Cooling system & leakage	I		I		I	

1st Service - 1500 km/2 months  
 2nd Service - 10000 km/12 months  
 3rd Service - 20000 km/24 months

**\*NOTICE :**

All Consumables, Wheel Alignment and / or Part Replacement (if not covered in warranty), if required are chargeable to the customer(s).

No.	Item Description	1st Service		2nd Service		3rd Service	
		Reqd.	Done	Reqd.	Done	Reqd.	Done
<b>C. VEHICLE ON LIFT</b>							
23	4WD Shaft differential Transfer case oil**	-		-		-	
24	Steering gear rack, linkage and boots	I		I		I	
27	Exhaust system	I		I		I	
28	Fuel filter (Petrol only)	-		-		-	
29	Fuel filter cartridge (Diesel only)*	-		-		R	
30	Charcoal Canister (Petrol only)	-		-		-	
31	Fuel tank air filter (Petrol only)**	-		-		-	
32	Front & rear suspension (linkages & ball joints)	I		I		I	
33	Fuel lines, hoses and connections	I		I		I	
34	Driveshafts & boots	I		I		I	
35	Fluid leakages	I		I		I	
36	Front and rear wheel bearing & bushes	I(IR)		I(IR)		I(IR)	
37	Front and rear disc/drum brakes & pads	I		I		I	
38	Parking brake (disc, shoe & operation)	I		I		I	
39	Wheel Alignment & Balancing*	-		I(IR)		I(IR)	
40	Tyre pressure, condition & rotation*	-		-		TR	
<b>D. FINAL CHECKS</b>							
41	Bolt and nuts on chassis and body	I		I		I	
42	Lubricate locks & hinges	I		L		L	
43	All electrical systems (drive belts, alternator)	I		I		I	
44	Warning lights operation & GDS System Check	I		I		I	
45	Ext & int. lights, horn & gauges	I		I		I	
46	Power window / sunroof operation (if equipped)	I		I		I	
47	All seat belt operation	I		I		I	
48	Road test	I(IR)		I(IR)		I(IR)	

\*\*if Applicable

## 2. Vehicle Information

Exterior overview (front view) .....	2-2
Exterior overview (rear view) .....	2-4
Interior overview .....	2-6
Center console overview .....	2-7
Engine compartment overview .....	2-8
Dimensions .....	2-9
Engine specification .....	2-9
Bulb wattage .....	2-10
Tires and wheels .....	2-12
Recommended lubricants and capacities .....	2-13
Recommended SAE viscosity number .....	2-14
Vehicle Identification Number (VIN) .....	2-15
Vehicle certification label .....	2-15
Tire specification and pressure label .....	2-16
Engine number .....	2-16
Air conditioner compressor label .....	2-16

## EXTERIOR OVERVIEW (FRONT VIEW)

■ 5 Door



The actual shape may differ from the illustration.

OAI3012001

1. Hood .....	5-29
2. Headlight .....	5-36, 9-68
3. Position light* .....	5-36, 9-68
4. Daytime running light* or daytime running light/position light* .....	5-40, 9-68
5. Tires and wheels .....	9-41
6. Outside rearview mirror .....	5-23
7. Front windshield wiper blades .....	9-34
8. Windows .....	5-25

\* : if equipped

## ■ 4 Door



The actual shape may differ from the illustration.

OAI3012025

1. Hood.....	5-29
2. Headlight.....	5-36, 9-68
3. Position light*.....	5-36, 9-68
4. Daytime running light* or daytime running light/position light*.....	5-40, 9-68
5. Tires and wheels.....	9-41
6. Outside rearview mirror.....	5-23
7. Front windshield wiper blades.....	9-34
8. Windows.....	5-25

\* : if equipped

## EXTERIOR OVERVIEW (REAR VIEW)

■ 5 Door



OAI3012002

1. Antenna*	5-77
2. Doors	5-14
3. Fuel filler door	5-33
4. High mounted stop light	9-75
5. Rear window wiper blade*	9-36
6. Wide-rear view camera*	7-6
7. Tailgate	5-30
8. Rear ultrasonic sensors*	7-8
9. Rear combination light	9-72
10. Rear reflex reflector	9-72
11. License plate light	9-75

\* : if equipped

■ 4 Door



The actual shape may differ from the illustration.

OAI3019026I

1. Antenna*	5-77
2. Doors	5-14
3. Fuel filler door	5-33
4. High mounted stop light	9-75
5. Trunk	5-32
6. Wide-rear view camera*	7-6
7. Rear ultrasonic sensors*	7-8
8. Rear combination light	9-72
9. Rear reflex reflector	9-72
10. License plate light	9-75

\* : if equipped

## INTERIOR OVERVIEW



The actual shape may differ from the illustration.

OAI3013003

1. Door lock/unlock button.....	5-16
2. Outside rearview mirror control switch*.....	5-23
3. Outside rearview mirror folding switch*.....	5-24
4. Central door lock/unlock switch.....	5-17
5. Power window switches.....	5-25
6. Power window lock switch.....	5-27
7. Headlight leveling device*.....	5-39
8. ESC (Electronic Stability Control) OFF button*.....	6-30
9. Fuse box.....	9-53
10. Key ignition switch.....	6-4
Engine Start/Stop button*.....	6-7
11. Steering wheel.....	5-19
12. Hood release lever.....	5-29
13. Fuel filler door opener.....	5-33
14. Seats.....	3-4

\* : if equipped



## CENTER CONSOLE OVERVIEW



OAI3013004

1. Wipers and Washers.....	5-43	10. Climate control system* .....	5-46
2. Light control/Turn signals .....	5-36	11. USB charger* .....	5-73
3. Instrument cluster .....	4-2	12. Power outlet* .....	5-72
4. Horn .....	5-21	13. USB port* .....	5-77
5. Steering wheel audio controls* .....	5-78	14. Shift lever .....	6-12, 6-15
6. Driving assist button .....	7-2	15. Passenger's front airbag* .....	3-44
7. Driver's airbag .....	3-44	16. Glove box .....	5-70
8. Infotainment system* .....	5-77	17. Rear Power outlet* .....	5-72
9. Hazard warning flasher switch .....	8-2	Rear USB charger* .....	5-73

\* : if equipped

## ENGINE COMPARTMENT OVERVIEW

■ Gasoline Engine (G 1.2 MPI)



The actual engine room in the vehicle may differ from the illustration.

OAI3089001

1. Engine coolant reservoir .....	9-23
2. Engine oil filler cap .....	9-20
3. Brake/clutch* fluid reservoir .....	9-26
4. Air cleaner .....	9-30
5. Fuse box .....	9-54
6. Battery .....	9-37
7. Windshield washer fluid reservoir .....	9-28
8. Radiator cap.....	9-24
9. Engine oil dipstick .....	9-20

## DIMENSIONS

### 5 Door

Item		mm (in)
Overall length		3,815 (150.2)
Overall width		1,680 (66.1)
Overall height		1,520 (59.8)
Front tread	165/70 R14	1,488 (58.6)
	175/60 R15	1,476 (58.1)
Rear tread	165/70 R14	1,503 (59.2)
	175/60 R15	1,491 (58.7)
Wheelbase		2,450 (96.5)

### 4 Door

Item		mm (in)
Overall length		3,995 (157.3)
Overall width		1,680 (66.1)
Overall height		1,520 (59.8)
Front tread	165/70 R14	1,488 (58.6)
	175/60 R15	1,476 (58.1)
Rear tread	165/70 R14	1,503 (59.2)
	175/60 R15	1,491 (58.7)
Wheelbase		2,450 (96.5)

## ENGINE SPECIFICATION

Item	Gasoline Engine	
	1.2 MPI	
Displacement	cc	1,197
Bore x Stroke	mm	71 x 75.6
Firing order	In-line	
No. of cylinders	4	

## BULB WATTAGE

### 5 Door

Light Bulb		Bulb type	Wattage	
Front	Type A	Headlight (high/low)	H19	60/55
		Parking (Position) light	W5W	5
		Parking (Position) light	LED	LED
		Turn signal light	PY21W	21
		Daytime Running Light (DRL) *	LED	LED
	Type B	Headlight (high/low)	HB3	60
		Parking (Position) light/ Daytime Running Light (if equipped)	LED	LED
		Turn signal light	PY21W	21
Side repeater light *		WY5W	5	
Side repeater light (outside mirror) *		LED	LED	
Rear	Tail light		LED	LED
	Stop light		P21W	21
	Turn signal light		PY21W	21
	Back up light		W16W	16
	Reflex reflector		-	-
	High mounted stop light*		W5W	20
	License plate light		W5W	10
Interior	Room lamp		FESTOON	8
	Luggage room lamp *		FESTOON	8

\* : If equipped

Type A : MFR (Multi Focus Reflector) headlight

Type B : Bi-Function projection headlight

#### 4 Door

Light Bulb		Bulb type	Wattage	
Front	Type A	Headlight (high/low)	H19	60/55
		Parking (Position) light	W5W	5
		Parking (Position) light	LED	LED
		Turn signal light	PY21W	21
		Daytime Running Light (DRL) *	LED	LED
	Type B	Headlight (high/low)	HB3	60
		Parking (Position) light/ Daytime Running Light (if equipped)	LED	LED
		Turn signal light	PY21W	21
Side repeater light *		WY5W	5	
Side repeater light (outside mirror) *		LED	LED	
Rear	Tail light		LED	LED
	Stop light		P21/5W	21
	Turn signal light		PY21W	21
	Back up light		W16W	16
	Reflex reflector		-	-
	High mounted stop light *		LED	LED
	License plate light		W5W	10
Interior	Front room lamp		FESTOON	8
	Center room lamp		FESTOON	8
	Luggage room lamp *		FESTOON	5

\* : If equipped

Type A : MFR (Multi Focus Reflector) headlight

Type B : Bi-Function projection headlight

## TIRES AND WHEELS

Type	Tire size	Wheel size	Inflation pressure kPa (psi)				Wheel lug nut torque kgf·m (lbf·ft, N·m)
			Normal load *1		Maximum load		
			Front	Rear	Front	Rear	
Full size tire	165/70R 14	5.0J X 14	240	230	250	250	11~13 (79-94, 107-127)
	175/60R 15	5.5J X 15	(35)	(33)	(36)	(36)	
Spare tire	165/70R 14	5.0J X 14	250 (35)				
	155/80R 13	4.5J X 13					

\*1 : Normal load : Up to 3 persons

### NOTICE

- It is permissible to add 20 kPa (3 psi) to the standard tire pressure specification if colder temperatures are expected soon. Tires typically lose 7 kPa (1 psi) for every 7°C (12°F) temperature drop. If extreme temperature variations are expected, recheck your tire pressure as necessary to keep them properly inflated.
- An air pressure generally decreases, as you drive up to a high-altitude area above sea level. Thus, if you plan to drive a high-altitude area, check the tire pressures in advance. If necessary, inflate them to a proper level (Air inflation per altitude: +10 kPa/1 km (+2.4 psi/1 mile)).
- Spare wheel are intended for emergency purpose.
- Only Steel wheel is provided as spare wheel. Spare tires can be from any manufacturer.

### CAUTION

When replacing tires, use the same size originally supplied with the vehicle. Using tires of a different size can damage the related parts or make it work irregularly.

## RECOMMENDED LUBRICANTS AND CAPACITIES

To help achieve proper engine and powertrain performance and durability, use only lubricants of the proper quality. The correct lubricants also help promote engine efficiency that results in improved fuel economy.

These lubricants and fluids are recommended for use in your vehicle.

Lubricant	Volume	Classification
Engine oil <sup>*1</sup> <sup>*2</sup> (drain and refill)	3.6 l (3.80 US qt.)	API Latest (ILSAC Latest)
Manual Transmission fluid	1.3 ~ 1.4 l (1.38~1.48 US qt.)	API Serviced GL-4, SAE 70W, TGO-9 (HYUNDAI genuine transmission fluid)
Automated Manual Transmission fluid	1.1~1.2 ℓ (1.16~1.27 US qt.)	
Coolant	5.32 l (5.62 US qt.)	MIXTURE, Antifreeze with water (Ethylene glycol base coolant for aluminum radiator)
Brake/Clutch fluid	0.7~0.8 l (0.7~0.8 US qt.)	FMVSS116 DOT-4
Fuel <sup>*3</sup>	37 l (9.8 US gal.)	-

\*1 : Refer to the recommended SAE viscosity numbers on the next page.

\*2 : Engine oils labeled Energy Conserving Oil are now available. Along with other additional benefits, they contribute to fuel economy by reducing the amount of fuel necessary to overcome engine friction. Often, these improvements are difficult to measure in everyday driving, but in a year's time, they can offer significant cost and energy savings.

\*3 : The fuel filling capacity mentioned is less than the actual fuel tank capacity. The extra capacity in the tank is provided to cater the vapour creation of fuel, to prevent leakage of volatile organic compounds and fuel into the atmosphere. Further, it is recommended that do not fill the tank after auto cut-off at the fuel station during filling fuel.

## Recommended SAE viscosity number



### CAUTION

Always be sure to clean the area around any filler plug, drain plug, or dipstick before checking or draining any lubricant. This is especially important in dusty or sandy areas and when the vehicle is used on unpaved roads. Cleaning the plug and dipstick areas will prevent dirt and grit from entering the engine and other mechanisms that could be damaged.

Engine oil viscosity (thickness) has an effect on fuel economy and cold weather operating (engine start and engine oil flowability). Lower viscosity engine oils can provide better fuel economy and cold weather performance, however, higher viscosity engine oils are required for satisfactory lubrication in hot weather.

Using oils of any viscosity other than those recommended could result in engine damage.

When choosing an oil, consider the range of temperature your vehicle will be operated in before the next oil change. Proceed to select the recommended oil viscosity from the chart.

		Temperature Range for SAE Viscosity Numbers									
Temperature	°C	-30	-20	-10	0	10	20	30	40	50	
	(°F)	-10	0	20	40	60	80	100	120		
Petrol Engine Oil		20W-50									
		15W-40									
		10W-30									
		0W-20, 0W-30, 5W-20, 5W-30									

\*1 : For better fuel economy, it is recommended to use the engine oil of a viscosity grade SAE 0W-20 (API Latest (ILSAC Latest)). However, if the engine oil is not available in your country, select the proper engine oil using the engine oil viscosity chart.



## VEHICLE IDENTIFICATION NUMBER (VIN)



The vehicle identification number (VIN) is the number used in registering your vehicle and in all legal matters pertaining to its ownership, etc.

The number is punched on the floor under the front right seat. To check the number, pull out the slit part of carpet.

## VEHICLE CERTIFICATION LABEL (IF EQUIPPED)

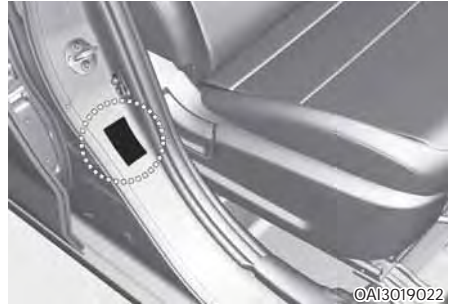

The vehicle certification label attached on the driver's (or front passenger's) side center pillar gives the vehicle identification number (VIN).

## TIRE SPECIFICATION AND PRESSURE LABEL



The tires supplied on your new vehicle are chosen to provide the best performance for normal driving. The tire label located on the driver's side center pillar gives the tire pressures recommended for your vehicle.

## ENGINE NUMBER

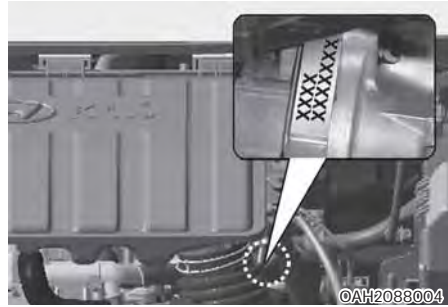

The engine number is stamped on the engine block as shown in the drawing.

## AIR CONDITIONER COMPRESSOR LABEL



A compressor label informs you the type of compressor your vehicle is equipped with such as model, supplier part number, production number, refrigerant (1) and refrigerant oil (2).

# 3. Safety System

This chapter provides you with important information about how to protect yourself and your passengers. It explains how to properly use your seats and seat belts, and how your airbags work.

Additionally, this chapter explains how to properly restrain infants and children in your vehicle.

- Important safety precautions ..... 3-2
  - Always wear your seat belt ..... 3-2
  - Restrain all children ..... 3-2
  - Airbag hazards ..... 3-2
  - Driver distraction ..... 3-2
  - Control your speed ..... 3-3
  - Keep your vehicle in safe condition ..... 3-3
- Seats ..... 3-4
  - Front seats ..... 3-7
  - Rear seats ..... 3-11
- Seat belts ..... 3-15
  - Seat Belt Warning Light ..... 3-16
  - Pre-tensioner seat belt ..... 3-21
  - Additional seat belt safety precautions ..... 3-23
  - Care of seat belts ..... 3-25
- Child restraint system ..... 3-26
  - Using a child restraint system ..... 3-28
  - Installing a Child Restraint System (CRS) ..... 3-29
- Airbag - Supplemental Restraint System (SRS) ..... 3-37
  - How does the airbag system operate ..... 3-38
  - Do not install a child restraint on the front passenger's seat ..... 3-40
  - Airbag warning and indicator ..... 3-41
  - SRS components and functions ..... 3-42
  - Driver's and passenger's front airbag ..... 3-45
  - Side airbag ..... 3-47
  - Curtain airbag ..... 3-48
  - SRS Care ..... 3-55
  - Airbag warning label ..... 3-58

### IMPORTANT SAFETY PRECAUTIONS

You will find many safety precautions and recommendations throughout this section, and throughout this manual. The safety precautions in this section are among the most important.

#### Always wear your seat belt

A seat belt is your best protection in all types of accidents. Airbags are designed to supplement seat belts, not replace them. So even though your vehicle is equipped with airbags, ALWAYS make sure you and your passengers wear the seat belts, and wear them properly.

#### Restrain all children

All children under age 13 ride in your vehicle should be restrained properly in a rear seat, not the front seat. Infants and small children should be restrained in an appropriate child restraint. Larger children should use a booster seat with the lap/shoulder belt until they can use the seat belt properly without a booster seat.

#### Airbag hazards

While airbags can save lives, they can also cause serious or fatal injuries to occupants who sit too close to them, or who are not properly restrained. Infants, young children, and short adults are at the greatest risk of being injured by an inflating airbag. Follow all instructions and warnings in this manual.

#### Driver distraction

Driver distraction presents a serious and potentially deadly danger, especially for inexperienced drivers. Safety should be the first concern when behind the wheel and drivers need to be aware of the wide array of potential distractions, such as drowsiness, reaching for objects, eating, personal grooming, other passengers, and using cellular phones.

Drivers can become distracted when they take their eyes and attention off the road or their hands off the wheel to focus on activities other than driving. To reduce your risk of distraction and an accident:

- ALWAYS set up your mobile devices (for example, MP3 players, phones, navigation units, etc.) when your vehicle is parked or safely stopped.
- ONLY use your mobile device when allowed by laws and conditions permit safe use.

NEVER text or email while driving. Most countries have laws prohibiting drivers from texting. Some countries and cities also prohibit drivers from using handheld phones.

- NEVER let the use of a mobile device distract you from driving. You have a responsibility to your passengers and others on the road to always drive safely, with your hands on the wheel as well as your eyes and attention on the road.

## Control your speed

Excessive speed is a major factor in crash injuries and deaths. Generally, the higher the speed, the greater the risk, but serious injuries can also occur at lower speeds. Never drive faster than is safe for current conditions, regardless of the maximum speed posted.

## Keep your vehicle in safe condition

Having a tire blowout or a mechanical failure can be extremely hazardous. To reduce the possibility of such problems, check your tire pressures and condition frequently, and perform all regularly scheduled maintenance.

## SEATS

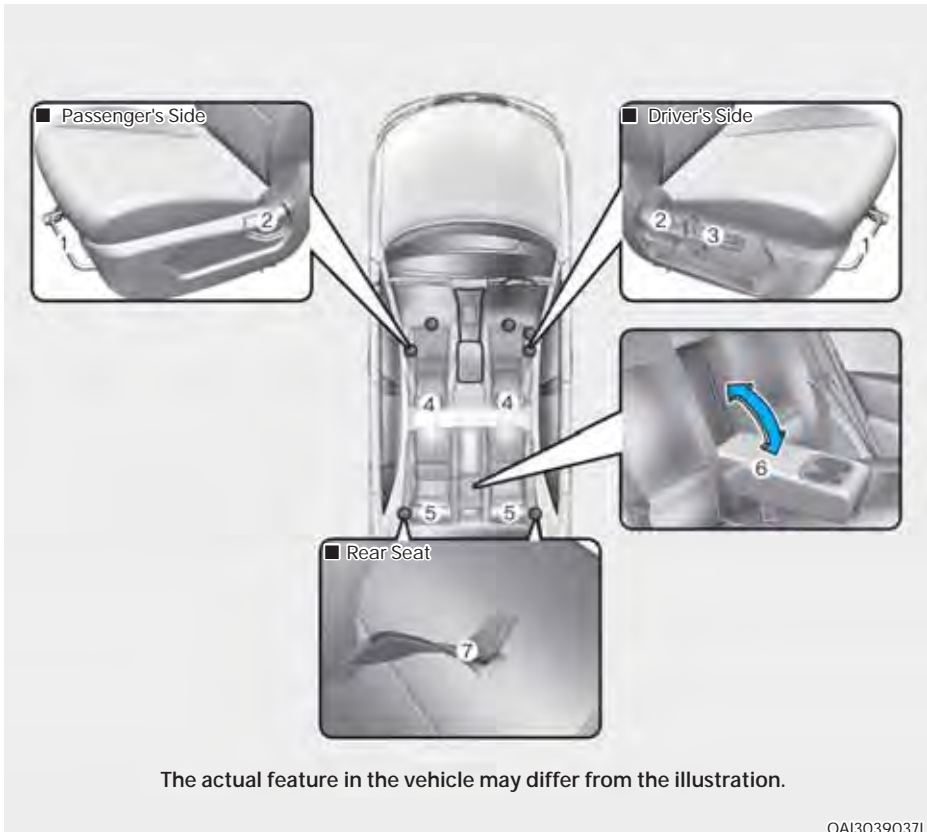

### Front seats

1. Forward and backward
2. Seatback angle
3. Seat height adjustment\*
4. Headrest\*

### Rear seats

5. Headrest (outboard)\*
6. Armrest\*
7. Seatback folding (5 Door)

\* : if equipped

 **WARNING**
**Loose objects**

Loose objects in the driver's foot area could interfere with the operation of the foot pedals, possibly causing an accident. Do not place anything under the front seats.

 **WARNING**
**Uprighting seat**

When you return the seatback to its upright position, hold the seatback and return it slowly and be sure there are no other occupants around the seat. If the seatback is returned without being held and controlled, the back of the seat could move forward or backward resulting in accidental injury.

 **WARNING**
**Driver responsibility for passengers**

Riding in a vehicle with seatback reclined could lead to serious or fatal injury in an accident. If a seat is reclined during an accident, the occupant's hips may slide under the lap portion of the seat belt applying great force to the unprotected abdomen. The protection of your restraint system (seat belt and airbags) is greatly reduced by reclining your seat. Serious or fatal internal injuries could result. The driver must advise the passenger to keep the seatback in an upright position whenever the vehicle is in motion.

 **WARNING**

Do not use a sitting cushion that reduces friction between the seat and passenger. The passenger's hips may slide under the lap portion of the seat belt during an accident or a sudden stop. Serious or fatal internal injuries could result because the seat belt can't operate normally.

 **WARNING**
**Driver's seat**

- Never attempt to adjust seat while the vehicle is moving. This could result in loss of control, and an accident causing death, serious injury, or property damage.
- Do not allow anything to interfere with the normal position of the seatback. Storing items against a seatback or in any other way interfering with proper locking of a seatback could result in serious or fatal injury in a sudden stop or collision.
- Always drive and ride with your seatback upright and the lap portion of the seat belt snug and low across the hips. This is the best position to protect you in case of an accident.
- In order to avoid unnecessary and perhaps severe airbag injuries, always sit as far back as possible from the steering wheel while maintaining comfortable control of the vehicle.

 **WARNING**

Rear seatbacks

- The rear seatback must be securely latched. If not, passengers and objects could be thrown forward resulting in serious injury or death in the event of a sudden stop or collision.
- Luggage and other cargo should be laid flat in the cargo area. If objects are large, heavy, or must be piled, they must be secured. Under no circumstances should cargo be piled higher than the seatbacks. Failure to follow these warnings could result in serious injury or death in the event of a sudden stop, collision or rollover.
- No passenger should ride in the cargo area or sit or lie on folded seatbacks while the vehicle is moving. All passengers must be properly seated in seats and restrained properly while riding.
- When resetting the seatback to the upright position, make sure it is securely latched by pushing it forward and backwards.
- To avoid the possibility of burns, do not remove the carpet in the cargo area. Emission control devices beneath this floor generate high temperatures.

 **WARNING**

After adjusting the seat, always check that it is securely locked into place by attempting to move the seat forward or backward without using the lock release lever. Sudden or unexpected movement of the driver's seat could cause you to lose control of the vehicle resulting in an accident.

 **WARNING**

- Do not adjust the seat while wearing seat belts. Moving the seat cushion forward may cause strong pressure on the abdomen.
- Use extreme caution so that hands or other objects are not caught in the seat mechanisms while the seat is moving.
- Do not put a cigarette lighter on the floor or seat. When you operate the seat, gas may gush out of the lighter and cause fire.
- If there are occupants in the rear seats, be careful while adjusting the front seat position.



## Front seats



OAI3039002

### Forward and rearward

To move the seat forward or rearward:

1. Pull the seat slide adjustment lever up and hold it.
2. Slide the seat to the position you desire.
3. Release the lever and make sure the seat is locked in place.

Adjust the seat before driving, and make sure the seat is locked securely by trying to move forward and rearward without using the lever. If the seat moves, it is not locked properly.



OAI3039003

### Seatback angle

To recline the seatback:

1. Lean forward slightly and lift up on the seatback recline lever.
2. Carefully lean back on the seat and adjust the seatback of the seat to the position you desire.
3. Release the lever and make sure the seatback is locked in place. (The lever **MUST** return to its original position for the seatback to lock.)



OAI3039004

### Seat height adjustment (for driver's seat, if equipped)

To change the height of the seat, move the lever upwards or downwards.

- To lower the seat, push the lever down several times.
- To raise the seat, pull the lever up several times.

### Headrest

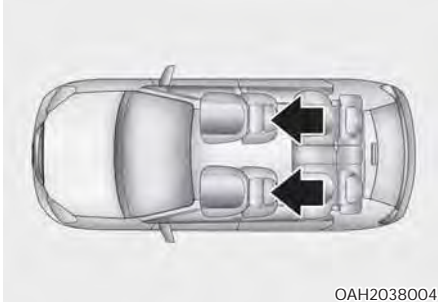

The driver's and front passenger's seats are equipped with a headrest for the occupant's safety and comfort.

The headrest not only provides comfort for the driver and front passenger, but also helps to protect the head and neck in the event of a collision.

#### **WARNING**

To help reduce the risk of serious injury or death in an accident, take the following precautions when adjusting your headrests:

- Always properly adjust the headrests for all passengers **BEFORE** starting the vehicle.
- **NEVER** let anyone ride in a seat with the headrests removed or reversed.



Adjust the headrests so the middle of the headrests is at the same height as the height of the top of the eyes.

- **NEVER** adjust the headrest position of the driver's seat when the vehicle is in motion.
- Adjust the headrest as close to the passenger's head as possible. Do not use a seat cushion that holds the body away from the seatback.
- Make sure the headrest locks into position after adjusting it.

#### **NOTICE**

To prevent damage, **NEVER** hit or pull on the headrests.



### NOTICE

If you recline the seatback towards the front with the head restraint and seat at top most position, the head restraint may come in contact with the sunvisor or other parts of the vehicle.

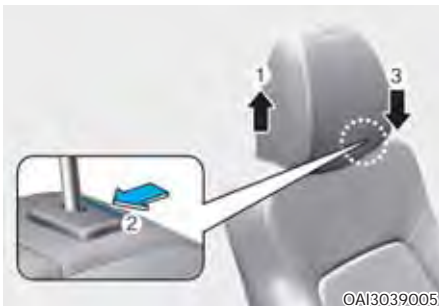

### Adjusting the height up and down

To raise the headrest, pull it up to the desired position (1). To lower the headrest, push and hold the release button (2) on the headrest support and lower the headrest to the desired position (3).



### Removal/Reinstall (if equipped)

To remove the headrest:

1. Recline the seatback (2) with the recline lever (1).
2. Raise headrest as far as it can go.
3. Press the headrest release button (3) while pulling the headrest up (4).

### WARNING

**NEVER** allow anyone to ride in a seat with the headrest removed.

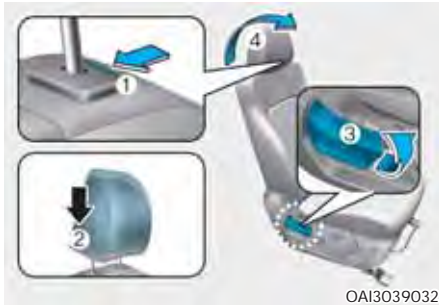

To reinstall the headrest :

1. Put the headrest poles (2) into the holes while pressing the release button (1).
2. Adjust the headrest to the appropriate height.
3. Adjust the seatback (4) forward using the recline lever (3).



**WARNING**

Always make sure the headrest locks into position after reinstalling and adjusting it properly.

*Seatback pocket (if equipped)*



The seatback pocket is provided on the back of the driver's and/or front passenger's seatback.



**WARNING**

**Seatback pockets**

Do not put heavy or sharp objects in the seatback pockets. In an accident, they could come loose from the pocket and injure vehicle occupants.

## Rear seats

### Headrest

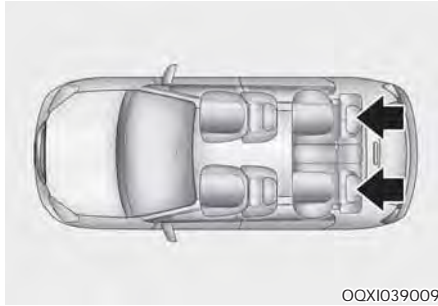

The rear seats are equipped with headrests in the outboard seating positions for the occupant's safety and comfort.

The headrest not only provides comfort for passengers, but also helps to protect the head and neck in the event of a collision.

### **WARNING**

To help reduce the risk of serious injury or death in an accident, take the following precautions when adjusting your headrests:

- Always properly adjust the headrests for all passengers **BEFORE** starting the vehicle.
- **NEVER** let anyone ride in a seat with the headrests removed.



Adjust the headrests so the middle of the headrests is at the same height as the height of the top of the eyes.

- **NEVER** adjust the headrest position of the driver's seat when the vehicle is in motion.
- Adjust the headrest as close to the passenger's head as possible. Do not use a seat cushion that holds the body away from the seatback.
- Make sure the headrest locks into position after adjusting it.

### **NOTICE**

To prevent damage, **NEVER** hit or pull on the headrests.

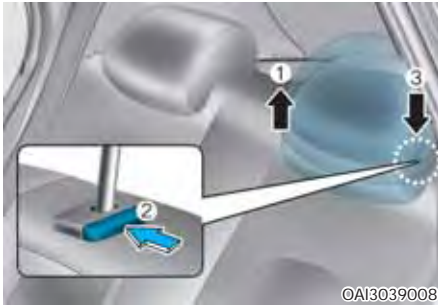

**Adjusting the height up and down (if equipped)**

To raise the headrest, pull it up (1). To lower the headrest, push and hold the release button (2) on the headrest support and lower the headrest (3).

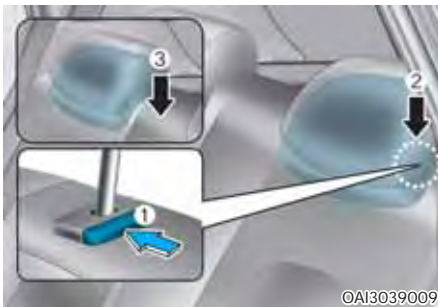

**Removal (if equipped)**

To remove the headrest, raise it as far as it can go then press the release button (1) while pulling upward (2).

To reinstall the headrest, put the headrest poles (3) into the holes while pressing the release button (1). Then adjust it to the appropriate height.

**⚠ WARNING**

Make sure the headrest locks in position after adjusting it to properly protect the occupants.

**Armrest (4 Door, if equipped)**



The armrest is located in the center of the rear seat. Pull the armrest down from the seatback to use it.

You will find cup holders on the center armrest.

**Folding the rear seat (5 Door, if equipped)**

The rear seatbacks (or cushions) may be folded to facilitate carrying long items or to increase the luggage capacity of the vehicle.

**⚠ WARNING**

- Never allow passengers to sit on top of the folded down seatback while the vehicle is moving as this is not a proper seating position and no seat belts are available for use. This could result in serious injury or death in case of an accident or sudden stop.
- Objects carried on the folded down seatback should not extend higher than the top of the front seats. This could allow cargo to slide forward and cause injury or damage during sudden stops.

1. Set the front seatback to the upright position and if necessary, slide the front seat forward.
2. Lower the rear headrests to the lowest position (if equipped with adjustable headrests).



3. Insert the rear lap/shoulder belt plate into the holder on the side trim. It will prevent the lap/shoulder belt from interfering with the seatback when folding.



4. Pull up both sides of the seatback lever and fold the seatback toward the front of the vehicle.

To use the rear seat, lift and push up the seatback backward. Push the seatback firmly until it clicks into place. Make sure the seatback is locked in place.

When returning the rear seatbacks to the upright position, remember to return the rear shoulder belts to their proper position.

### **i** Information

**If you are not able to pull out the seat belt from the retractor, firmly pull the belt out and release it. Then you will be able to pull the belt out smoothly.**



### WARNING

When you return the rear seatback to its upright position after being folded down:

Be careful not to damage the seat belt webbing or buckle. Do not allow the seat belt webbing or buckle to get caught or pinched in the rear seat. Ensure that the seatback is completely locked into its upright position by pushing on the top of the seatback. Otherwise, in an accident or sudden stop, the seat could fold down and allow cargo to enter the passenger compartment, which could result in serious injury or death.

### NOTICE

- When returning the rear seatbacks to the upright position, remember to return the rear shoulder belts to their proper position.
- Routing the seat belt webbing through the rear seat belt guides will help keep the seat belts from being trapped behind or under the seats.



### WARNING

Cargo

Cargo should always be secured to prevent it from being thrown about the vehicle in a collision and causing injury to the vehicle occupants. Do not place objects in the rear seats, since they cannot be properly secured and may hit the front seat occupants in a collision.



### WARNING

Cargo loading

Make sure the engine is off, the Automated manual transmission is in N (Neutral) or the Manual transmission is in R (Reverse) or 1st, and the parking brake is securely applied whenever loading or unloading cargo. Failure to take these steps may allow the vehicle to move if the shift lever is inadvertently moved to another position.



## SEAT BELTS

### WARNING

- For maximum restraint system protection, the seat belts must always be used whenever the car is moving.
- Seat belts are most effective when seatbacks are in the upright position.
- Children age 12 and under must always be properly restrained in the rear seat. Never allow children to ride in the front passenger seat. If a child over 12 must be seated in the front seat, move the seat as far back as possible. And the child must always be restrained in the seat properly.
- Never wear the shoulder belt under your arm or behind your back. An improperly positioned shoulder belt can cause serious injuries in a crash. The shoulder belt should be positioned midway over your shoulder across your collarbone.
- Never wear a seat belt over fragile objects. If there is a sudden stop or impact, the seat belt can damage it.
- Avoid wearing twisted seat belts. A twisted belt can't do its job as well. In a collision, it could even cut into you. Be sure the belt webbing is straight and not twisted.
- Be careful not to damage the belt webbing or hardware. If the belt webbing or hardware is damaged, replace it.

### WARNING

Seat belts are designed to bear upon the bony structure of the body, and should be worn low across the front of the pelvis or the pelvis, chest and shoulders, as applicable; wearing the lap section of the belt across the abdominal area must be avoided.

Seat belts should be adjusted as firmly as possible, consistent with comfort, to provide the protection for which they have been designed.

A slack belt will greatly reduce the protection afforded to the wearer.

Care should be taken to avoid contamination of the webbing with polishes, oils and chemicals, and particularly battery acid. Cleaning may safely be carried out using mild soap and water. The belt should be replaced if webbing becomes frayed, contaminated or damaged.

It is essential to replace the entire assembly after it has been worn in a severe impact even if damage to the assembly is not obvious. Belts should not be worn with straps twisted. Each belt assembly must only be used by one occupant; it is dangerous to put a belt around a child being carried on the occupant's lap.



## WARNING

- No modifications or additions should be made by the user which will either prevent the seat belt adjusting devices from operating to remove slack, or prevent the seat belt assembly from being adjusted to remove slack.
- When you fasten the seat belt, be careful not to latch the seat belt in buckles of other seat. It's very dangerous and you may not be protected by the seat belt properly.
- Do not unfasten the seat belt and do not fasten and unfasten the seat belt repeatedly while driving. This could result in loss of control, and an accident causing death, serious injury, or property damage.
- When fastening the seat belt, make sure that the seat belt does not pass over objects that are hard or can break easily.
- Make sure there is nothing in the buckle interfering with the seat belt latch mechanism, because any materials in the buckle can cause the seat belt not to be fastened securely.

## Seat Belt Warning Light

### *Driver's seat belt warning*

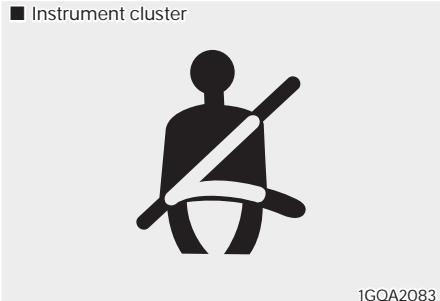

As a reminder to the driver, the driver's seat belt warning light will illuminate for approximately 6 seconds each time you turn the ignition switch or Engine Start/ Stop button ON regardless of seat belt fastening.

If you start to drive without the seat belt fastened or you unfasten the seat belt when you drive under 20 km/h (12 mph) or stop, the corresponding warning light will illuminate.

If you start to drive without the seat belt fastened or you unfasten the seat belt when you drive 20 km/h (12 mph) and faster, the warning light will blink and warning chime will sound for approximately 100 seconds.

When the seat belt is unfastened during driving, the warning light will illuminate when the speed is under 20 km/h (12 mph).

When the speed is 20 km/h (12 mph) and faster, the warning light will blink and warning chime will sound for approximately 100 seconds.

## Front passenger's seat belt warning

■ Instrument cluster



As a reminder to the front passenger, the front passenger's seat belt warning lights will illuminate for approximately 6 seconds each time you turn the ignition switch or Engine Start/Stop button ON regardless of belt fastening.

If you start to drive without the seat belt fastened or you unfasten the seat belt when you drive under 20 km/h (12 mph) or stop, the corresponding warning light will illuminate.

If you start to drive without the seat belt fastened or you unfasten the seat belt when you drive 20 km/h (12 mph) and faster, the warning light will blink and warning chime will sound for approximately 100 seconds.

When the seat belt is fastened during driving, the warning light will illuminate when the speed is under 20 km/h (12 mph). When the speed is 20 km/h (12 mph) and faster, the warning light will blink and warning chime will sound for approximately 100 seconds.

## WARNING

Riding in an improper position adversely affects the front passenger's seat belt warning system. It is important for the driver to instruct the passenger to be seated properly as instructed in this manual.

## Information

- **Although the front passenger seat is not occupied, the seat belt warning light will blink or illuminate for 6 seconds.**
- **The front passenger's seat belt warning may operate when luggage is placed on the front passenger seat.**

### Rear passenger's seat belt warning

■ Instrument cluster



#### For rear left and right side seat

As a reminder to the rear passenger, the rear passenger's seat belt warning lights will illuminate for approximately 6 seconds each time you turn the ignition switch or Engine Start/Stop button ON regardless of belt fastening.

If you start to drive without the seat belt fastened or you unfasten the seat belt when you drive under 20 km/h (12 mph), the corresponding warning light will continue to illuminate until you fasten the seat belt.

If you continue to drive without the seat belt fastened or you unfasten the seat belt when you drive 20 km/h (12 mph) and faster, the seat belt warning chime will sound for approximately 35 seconds and the corresponding warning light will blink.

When the seat belt is unfastened during driving, the warning light will illuminate when the speed is under 20 km/h (12 mph).

When the speed is 20 km/h (12 mph) and faster, the warning light will blink and warning chime will sound for approximately 35 seconds.

### WARNING

Riding in an improper position adversely affects the rear passenger's seat belt warning system.

It is important for the driver to instruct the passenger to properly be seated as instructed in this manual.

### Information

- **Although the rear side passenger seat is not occupied, the seat belt warning light will blink or illuminate for 6 seconds.**
- **The rear side passenger's seat belt warning may operate when luggage, laptop or other electronic device is placed on the rear side passenger seat.**

#### For rear center seat

As a reminder to the rear passenger, the rear passenger's seat belt warning light will illuminate for approximately 6 seconds each time you turn the ignition switch or Engine Start/Stop button ON regardless of belt fastening.

If the seat belt is not fastened when the ignition switch or Engine Start/Stop button is turned ON, the seat belt warning light will illuminate for approximately 70 seconds.

If you start to drive without the seat belt fastened or you unfasten the seat belt when you drive under 20 km/h (12 mph), the corresponding warning light will continue to illuminate for approximately 70 seconds.

If you continue to drive without the seat belt fastened or you unfasten the seat belt when you drive over 20 km/h (12 mph), the seat belt warning chime will sound for approximately 35 seconds and the corresponding warning light will blink.

If the rear door is opened or closed under 10 km/h (6 mph), warning light and warning sound does not work even if driving over 20 km/h (12 mph).

### Rear seat belt warning

As a reminder to the rear passenger, the rear passenger seat belt warning lights will illuminate for approximately 6 seconds each time you turn the ignition switch ON regardless of belt fastening.

Whether a passenger is seated or not, if the seat belt is not fastened when the ignition switch is turned ON, the seat belt warning light will illuminate for approximately 70 seconds.

If you start to drive without the seat belt fastened the corresponding warning light will continue to illuminate for approximately 70 seconds regardless of the speed.

After wearing the seat belt, if you unfasten it when you drive under 20 km/h (12.4 mi.), the corresponding warning light will continue to illuminate for approximately 70 seconds.

After wearing the seat belt, if you unfasten it when you drive over 20 km/h (12.4 mi.), the seat belt warning chime will sound for approximately 35 seconds and the corresponding warning light will blink.

If the rear door is opened or closed under 10 km/h (6.2 mi.), warning light and warning sound do not work even if driving over 20 km/h (12.4 mi.).

### **i** Information

- **You can find the front passenger's seat belt warning light on the cluster.**
- **Although the front passenger seat is not occupied, the seat belt warning light will blink or illuminate for 6 seconds.**
- **The front passenger's seat belt warning may operate when luggage is placed on the front passenger seat.**

### Lap/shoulder belt



#### To fasten your seat belt:

To fasten your seat belt, pull it out of the retractor and insert the metal tab (1) into the buckle (2). There will be an audible "click" when the tab locks into the buckle.



You should place the lap belt (1) portion across your hips and the shoulder belt (2) portion across your chest.

The seat belt automatically adjusts to the proper length only after the lap belt portion is adjusted manually so that it fits snugly around your hips. If you lean forward in a slow and easy motion, the belt will extend and let you move around. If there is a sudden stop or impact, however, the belt will lock into position. It will also lock if you try to lean forward too quickly.

### **i** Information

**If you are not able to pull out the safety belt from the retractor, firmly pull the belt out and release it. After release, you will be able to pull the belt out smoothly.**

### WARNING

Improperly positioned seat belts may increase the risk of serious injury in an accident. Take the following precautions when adjusting the seat belt:

- Position the lap portion of the seat belt as low as possible across your hips, not on your waist, so that it fits snugly. This allows your strong pelvic bones to absorb the force of the crash, reducing the chance of internal injuries.
- Position one arm under the shoulder belt and the other over the belt, as shown in the illustration.
- Always position the shoulder belt anchor into the locked position at the appropriate height.
- Never position the shoulder belt across your neck or face.



### WARNING

You should place the lap belt portion as low as possible and snugly across your hips, not on your waist. If the lap belt is located too high on your waist, it may increase the chance of injury in the event of a collision. Both arms should not be under or over the belt. Rather, one should be over and the other under, as shown in the illustration.

Never wear the seat belt under the arm nearest the door.



#### **To release the seat belt:**

The seat belt is released by pressing the release button (1) in the locking buckle. When it is released, the belt should automatically draw back into the retractor.

If this does not happen, check the belt to be sure it is not twisted, then try again.

### 3-point rear center seat belt



Insert the tongue plate (1) into the buckle (2) until an audible “click” is heard, indicating the latch is locked. Make sure the belt is not twisted. When using the rear center seat belt, the buckle with the “CENTER” mark must be used.

#### Information

**If you are not able to pull out the safety belt from the retractor, firmly pull the belt out and release it. After release, you will be able to pull the belt out smoothly.**

#### WARNING

Make sure that the seatback is locked in place when using the rear center seat belt.

If not, the seatback may move when there is a sudden stop or collision, which could result in serious injury.

### Pre-tensioner seat belt (if equipped)



Your vehicle is equipped with driver's and front passenger's pre-tensioner seat belts (retractor pre-tensioner). The purpose of the pre-tensioner is to make sure the seat belts fit tightly against the occupant's body in certain frontal or side collision(s). The pre-tensioner seat belts may be activated in crashes where the frontal or side collision(s) is severe enough, together with the airbags. When the vehicle stops suddenly, or if the occupant tries to lean forward too quickly, the seat belt retractor will lock into position. In certain frontal collisions, the pre-tensioner will activate and pull the seat belt into tighter contact against the occupant's body.

#### WARNING

**For your safety, be sure that the belt webbing is not loose or twisted and always sit properly on your seat.**

### WARNING

- Always wear your seat belt and sit properly in your seat.
- Do not use the seat belt if it is loose or twisted. A loose or twisted seat belt will not protect you properly in an accident.
- Do not place anything near the buckle. This may adversely affect the buckle and cause it to function improperly.
- Always replace your pre-tensioners after activation or an accident.
- NEVER inspect, service, repair or replace the pre-tensioners by yourself. This must be done by an authorized HYUNDAI dealer.
- Do not hit the seat belt assemblies.

### WARNING

Do not touch the pre-tensioner seat belt assemblies for several minutes after they have been activated. When the pre-tensioner seat belt mechanism deploys during a collision, the pre-tensioner can become hot and can burn you.

### CAUTION

Body work on the front area of the vehicle may damage the pre-tensioner seat belt system. Therefore, we recommend the system to be serviced by an authorized HYUNDAI dealer.

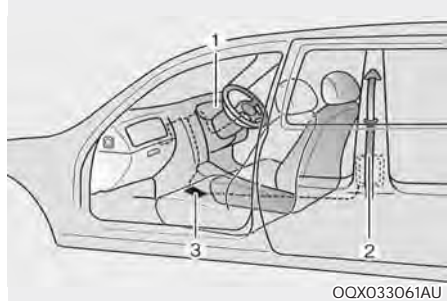

The seat belt pre-tensioner system consists mainly of the following components. Their locations are shown in the illustration:

- (1) SRS airbag warning light
- (2) Retractor pre-tensioner assembly
- (3) SRS control module



**NOTICE**

The sensor that activates the SRS control module is connected with the pre-tensioner seat belts. The SRS airbag warning light on the instrument cluster will illuminate for approximately 6 seconds after the ignition switch is placed in the ON position, and then it should turn off. If the pre-tensioner is not working properly, the warning light will illuminate even if the SRS airbag is not malfunctioning. If the warning light does not illuminate, stays illuminated or illuminates when the vehicle is being driven, we recommend the pre-tensioner seat belts and/or SRS control module be inspected by an authorized HYUNDAI dealer as soon as possible.

**i** Information

- Both the driver's and front passenger's pre-tensioner seat belts may be activated in certain frontal or side collisions.
- When the pre-tensioner seat belts are activated, a loud noise may be heard and fine dust, which may appear to be smoke, may be visible in the passenger compartment. These are normal operating conditions and are not hazardous.
- Although it is non-toxic, the fine dust may cause skin irritation so you should not be inhaled for prolonged periods. Wash all exposed skin areas thoroughly after an accident in which the pre-tensioner seat belts were activated.

**Additional seat belt safety precautions****Seat belt use during pregnancy**

The seat belt should always be used during pregnancy. The best way to protect your unborn child is to protect yourself by always wearing the seat belt. Pregnant women should always wear a lap-shoulder seat belt. Place the shoulder belt across your chest, routed between your breasts and away from your neck. Place the lap belt below your belly so that it fits SNUGLY across your hips and pelvic bone, under the rounded part of the belly.

**WARNING**

- Pregnant women and patients are more vulnerable to any impacts on the abdomen during an abrupt stop or accident. If you are in an accident while pregnant, consult your doctor.
- To reduce the risk of serious injury or death to an unborn child during an accident, pregnant women should NEVER place the lap portion of the seat belt above or over the area of the abdomen where the unborn child is located.

**Seat belt use and children****Infant and small children**

Most countries have Child Restraint System laws which require children to travel in approved Child Restraint System devices, including booster seats. The age at which seat belts can be used instead of the Child Restraint System differs among countries, so you should be aware of the specific requirements in your country, and where you are travelling. Infant and Child Restraint System must be properly placed and installed in a rear seat. For more details, refer to the "Child Restraint Systems" in this chapter.



### WARNING

**ALWAYS** properly restrain infants and small children in a Child Restraint System appropriate for the child's height and weight. To reduce the risk of serious injury or death to a child and other passengers, **NEVER** hold a child in your lap or arms when the vehicle is moving. The violent forces created during an accident will tear the child from your arms and throw the child against the interior of the vehicle.

Small children are best protected from injury in an accident when properly restrained in the rear seat by a Child Restraint System that meets the requirements of the Safety Standards of your country. Before buying any Child Restraint System, make sure that it has a label certifying that it meets Safety Standard of your country. The Child Restraint System must be appropriate for your child's height and weight. Check the label on the Child Restraint System for this information. Refer to "Child Restraint Systems" in this chapter.

### Larger children

Children under age 13 and who are too large for a booster seat should always occupy the rear seat and use the available lap/shoulder belts. A seat belt should lie across the upper thighs and be snug across the shoulder and chest to restrain the child safely. Check belt fit periodically. A child's squirming could put the belt out of position. In the event of an accident, children are afforded the best safety restrained by a proper Child Restraint System in the rear seats.

If a larger child over age 13 must be seated in the front seat, the child must be securely restrained by the available lap/shoulder belt and the seat should be placed in the rearmost position. If the shoulder belt portion slightly touches the child's neck or face, try placing the child closer to the center of the vehicle. If the shoulder belt still touches their face or neck, they need to be returned to an appropriate booster seat in the rear seat.



### WARNING

- **Always** make sure larger children's seat belts are worn and properly adjusted.
- **NEVER** allow the shoulder belt to contact the child's neck or face.
- **Do not** allow more than one child to use a single seat belt.

### *Seat belt use and injured people*

A seat belt should be used when an injured person is being transported. Consult a physician for specific recommendations.

### *One person per belt*

Two people (including children) should never attempt to use a single seat belt. This could increase the severity of injuries in case of an accident.

### ***Do not lie down***

Sitting in a reclined position when the vehicle is in motion can be dangerous. Even when buckled up, the protections of your restraint system (seat belts and/or airbags) is greatly reduced by reclining your seatback. Seat belts must be snug against your hips and chest to work properly. During an accident, you could be thrown into the seat belt, causing neck or other injuries.

The more the seat back is reclined, the greater the chance for the passenger's hips to slide under the lap belt or the passenger's neck to strike the shoulder belt.



### **WARNING**

- **NEVER** ride with a reclined seatback when the vehicle is moving.
- Riding with a reclined seatback increases your chance of serious or fatal injuries in the event of a collision or sudden stop.
- Driver and passengers should always sit well back in their seats with the seatbacks upright and should be belted properly.

### **Care of seat belts**

Seat belt systems should never be disassembled or modified. In addition, care should be taken to assure that seat belts and belt hardware are not damaged by seat hinges, doors or other abuse.

#### ***Periodic inspection***

All seat belts should be inspected periodically for wear or damage of any kind. Any damaged parts should be replaced as soon as possible.

#### ***Keep belts clean and dry***

Seat belts should be kept clean and dry. If belts become dirty, they can be cleaned by using a mild soap solution and warm water. Bleach, dye, strong detergents or abrasives should not be used because they may damage and weaken the fabric.

#### ***When to replace seat belts***

The entire seat belt assembly or assemblies should be replaced if the vehicle has been involved in an accident. This should be done even if no damage is visible. We recommend that you consult with an authorized HYUNDAI dealer.

## CHILD RESTRAINT SYSTEM

Children riding in the car should sit in the rear seat and must always be properly restrained to minimize the risk of injury in an accident, sudden stop or sudden maneuver. According to accident statistics, children are safer when properly restrained in the rear seats than in the front seat. Larger children not in a child restraint should use one of the seat belts provided.

You should be aware of the specific requirements in your country. Child and/or infant safety seats must be properly placed and installed in the rear seat. You must use a commercially available child restraint system that meets the requirements of the Safety Standards of your country.

Child restraint systems are designed to be secured in vehicle seats by the lap belt portion of a lap/shoulder belt.

Children could be injured or killed in a crash if their restraints are not properly secured. For small children and babies, a child seat or infant seat must be used.

Before buying a particular child restraint system, make sure it fits your car seat and seat belts, and fits your child. Follow all the instructions provided by the manufacturer when installing the child restraint system.



### WARNING

- A child restraint system must be placed in the rear seat. Never install a child or infant seat on the front passenger's seat. Should an accident occur and cause the passenger-side airbag to deploy, it could severely injure or kill an infant or child seated in an infant or child seat. Thus, only use a child restraint in the rear seat of your vehicle.
- A seat belt or child restraint system can become very hot if it is left in a closed vehicle on a sunny day, even if the outside temperature does not feel hot. Be sure to check the seat cover and buckles before placing a child there.
- When the child restraint system is not in use, store it in the luggage area or fasten it with a seat belt so that it will not be thrown forward in the case of a sudden stop or an accident.
- Children may be seriously injured or killed by an inflating airbag. All children, even those too large for child restraints, must ride in the rear seat.



## WARNING

To reduce the chance of serious or fatal injuries:

- Children of all ages are safer when restrained in the rear seat. A child riding in the front passenger seat can be forcefully struck by an inflating airbag resulting in serious or fatal injuries.
- Always follow the instructions for installation and use of the child restraint maker.
- Always make sure the child seat is secured properly in the car and your child is securely restrained in the child seat.
- Never hold a child in your arms or lap when riding in a vehicle. The violent forces created during a crash will tear the child from your arms and throw the child against the car's interior.
- Never put a seat belt over yourself and a child. During a crash, the belt could press deep into the child causing serious internal injuries.
- Never leave children unattended in a vehicle - not even for a short time. The car can heat up very quickly, resulting in serious injuries to children inside. Even very young children may inadvertently cause the vehicle to move, entangle themselves in the windows, or lock themselves or others inside the vehicle.
- Never allow two children, or any two persons, to use the same seat belt.
- Children often squirm and reposition themselves improperly. Never let a child ride with the shoulder belt under their arm or behind their back. Always properly position and secure children in rear seat.
- Never allow a child to stand-up or kneel on the seat or floorboard of a moving vehicle. During a collision or sudden stop, the child can be violently thrown against the vehicles interior, resulting in serious injury.
- Never use an infant carrier or a child safety seat that "hooks" over a seatback, it may not provide adequate security in an accident.
- Seat belts can become very hot, especially when the car is parked in direct sunlight. Always check seat belt buckles before fastening them over a child.
- After an accident, we recommend that the system be checked by an authorized HYUNDAI dealer.
- If there is not enough space to place the child restraint system because of the driver's seat, install the child restraint system in the rear right seat.

### Using a child restraint system

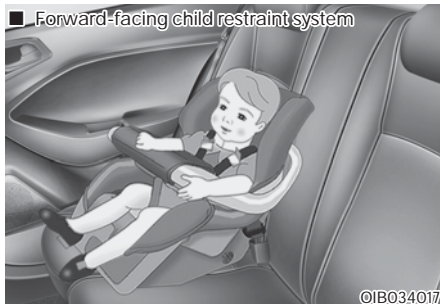
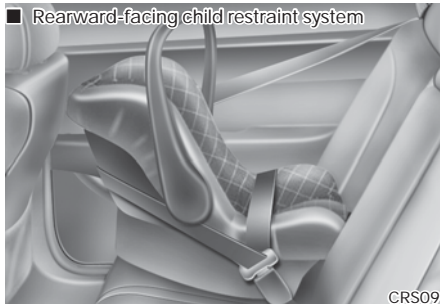

For small children and babies, the use of a child seat or infant seat is required. This child seat or infant seat should be of appropriate size for the child and it should be installed in accordance with the manufacturer's instructions.

For safety reasons, we recommend that the child restraint system is used in the rear seats.

### WARNING

Never place a rear-facing child restraint in the front passenger seat, because of the danger that an inflating passenger-side airbag could impact the rear-facing child restraint and kill the child.

### WARNING

#### Child seat installation

- A child can be seriously injured or killed in a collision if the child restraint is not properly anchored to the car and the child is not properly restrained in the child restraint. Before installing the child restraint system, read the instructions supplied by the child restraint system manufacturer.
- If the seat belt does not operate as described in this section, we recommend that the system be checked by an authorized HYUNDAI dealer.
- Failure to observe this manual's instructions regarding child restraint system and the instructions provided with the child restraint system could increase the risk and/or severity of injury in an accident.

## Installing a Child Restraint System (CRS)

### WARNING

Before installing your Child Restraint System always:

- Read and follow the instructions provided by the manufacturer of the Child Restraint System.

Failure to follow all warnings and instructions could increase the risk of the SERIOUS INJURY or DEATH if an accident occurs.

### WARNING

If the vehicle headrest prevents proper installation of a Child Restraint System (as described in the Child Restraint System manual), the headrest of the respective seating position shall be readjusted or entirely removed.

After selecting a proper Child Restraint System and checking that the Child Restraint System fits properly in the rear of this vehicle, you are ready to install the Child Restraint System according to the manufacturer's instruction. There are three general steps in installing the Child Restraint System properly:

- **Properly secure the Child Restraint System to the vehicle.** All Child Restraint Systems must be secured to the vehicle with the lap belt or lap part of a lap/shoulder belt or with the top-tether and/or ISOFIX anchorage.
- **Make sure the Child Restraint System is firmly secured.** After installing a Child Restraint System to the vehicle, push and pull the Child Restraint System forward and from side-to-side to verify that it is securely attached to the vehicle seat. A Child Restraint System secured with a seat belt should be installed as firmly as possible. However, some side-to-side movement can be expected.

When installing a Child Restraint System, adjust the vehicle seat (up and down, forward and rearward) so that your child fits in the Child Restraint System in a comfortable manner.

- **Secure the child in the Child Restraint System.** Make sure the child is properly strapped in the Child Restraint System according to the Child Restraint System manufacturer's instructions.

### WARNING

A Child Restraint System in a closed vehicle can become very hot. To prevent burns, check the seating surface and buckles before placing your child in the Child Restraint System.

### ***ISOFIX anchorage and top-tether anchorage (ISOFIX system) for children (if equipped)***

The ISOFIX system holds a Child Restraint System during driving and in an accident. This system is designed to make installation of the Child Restraint System easier and reduce the possibility of improperly installing your Child Restraint System. The ISOFIX system uses anchors in the vehicle and attachments on the Child Restraint System. The ISOFIX system eliminates the need to use seat belts to secure the Child Restraint System to the rear seats. ISOFIX anchors are metal bars built into the vehicle. There are two lower anchors for each ISOFIX seating position that will accommodate a Child Restraint System with lower attachments.

To use the ISOFIX system in your vehicle, you must have a Child Restraint System with ISOFIX attachments. (An ISOFIX-Child Restraint System may only be installed if it has vehicle-specific or universal approval in accordance with the requirements of ECE-R 44 or ECE-R 129.)

The Child Restraint System manufacturer will provide you with instructions on how to use the Child Restraint System with its attachments for the lower anchorages.

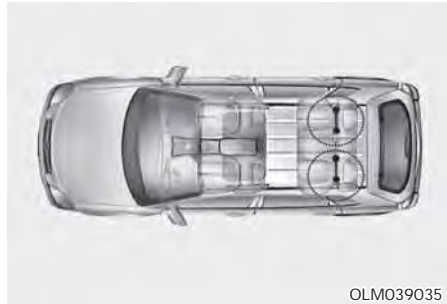

ISOFIX anchorages have been provided in the left and right outboard rear seating positions. Their locations are shown in the illustration. There are no ISOFIX anchorages provided for the center rear seating position.

### **WARNING**

**Do not attempt to install a Child Restraint System using ISOFIX anchorages in the rear center seating position. There are no ISOFIX anchorages provided for this seat.**

**Using the outboard seat anchorages, for the CRS installation on the rear center seating position, can damage the anchorages which may break or fail in a collision resulting in serious injury or death.**





The ISOFIX anchorages symbols are located on the left and right rear seat cushions to identify the position of the ISOFIX anchorages in your vehicle (see arrows in illustration).



Both rear outboard seats are equipped with a pair of ISOFIX anchorages as well as a corresponding top-tether anchorage on the back side of the rear seats.

(Child Restraint Systems with universal approval according to ECE-R44 or ECE-R129 need to be fixed additionally with a top-tether connected to the corresponding top-tether anchorage point on the back side of the rear seats.)

ISOFIX anchorages are located between the seatback and the seat cushion of the rear seat left and right outboard seating positions.

### ***Securing a Child Restraint System with the "ISOFIX system"***

To install a ISOFIX-compatible Child Restraint System in either of the rear outboard seating positions:

1. Move the seat belt buckle away from the ISOFIX anchorages.
2. Move any other objects away from the anchors that could prevent a secure connection between the Child Restraint System and the ISOFIX anchorages.
3. Place the Child Restraint System on the vehicle seat, then attach the seat to the ISOFIX anchorages according to the instructions provided by the Child Restraint System manufacturer.
4. Follow the instructions of the Child Restraint System's manufacturer for proper installation and connection of the ISOFIX attachments on the Child Restraint System to the ISOFIX anchorages.

### **⚠ WARNING**

Take the following precautions when using the ISOFIX system:

- Read and follow all installation instructions provided with your Child Restraint System.
- To prevent the child from reaching and taking hold of unretracted seat belts, buckle all unused rear seat belts and retract the seat belt webbing behind the child. Children can be strangled if a shoulder belt becomes wrapped around their neck and the seat belt tightens.

- NEVER attach more than one Child Restraint System to a single anchorage. This could cause the anchor or attachment to come loose or break.
- Always have the ISOFIX system inspected by your dealer after an accident. An accident can damage the ISOFIX system and may not properly secure the Child Restraint System.

### *Securing a Child Restraint System with "Top-tether anchorage" system (if equipped)*



Top-tether anchorages for Child Restraint Systems are located on the floor of the luggage room (5 Door) or on the package tray (4 Door).

### **WARNING**

Take the following precautions when installing the top-tether:

- Read and follow all installation instructions provided with your Child Restraint System.
- NEVER attach more than one Child Restraint System to a single top-tether anchorage. This could cause the anchorage or attachment to come loose or break.
- Do not attach the top-tether to anything other than the correct top-tether anchorage. It may not work properly if attached to something else.
- Child Restraint System anchorages are designed to withstand only those loads imposed by correctly fitted Child Restraint Systems. Do not use them for adult seat belts, harnesses, or for attaching other items or equipment to the vehicle.



To install the top-tether :

1. Route the Child Restraint System top-tether over the Child Restraint System seatback. Route the top-tether under the headrest and between the headrest posts, or route the top-tether over the top of the vehicle seatback. Make sure the strap is not twisted.
2. Connect the top-tether to the top-tether anchorage, then tighten the top-tether according to the instructions of your Child Restraint System's manufacturer to firmly attach the Child Restraint System to the seat.
3. Check that the Child Restraint System is securely attached to the seat by pushing and pulling the seat forward and from side-to-side.

### Child Seat Restraint Suitability for Seat Position using the Seat Belt

Suitability of each seating position for “universal” category belted Child Restraint Systems according to ECE regulations. Use Child Restraint Systems that have been officially approved and are appropriate for your children. When using the Child Restraint Systems, refer to the following table.

Mass Group	Size Class	Fixture	Vehicle ISOFIX Positions			
			Front Passenger	Outboard Left	2nd row Center	Outboard Right
Carrycot	F	ISO/L1	N/A	X	N/A	X
	G	ISO/L2	N/A	X	N/A	X
0 : UP to 10 kg	E	ISO/R1	N/A	IL	N/A	IL
	E	ISO/R1	N/A	IL	N/A	IL
0+ : UP to 13 kg	D	ISO/R2	N/A	IL	N/A	IL
	C	ISO/R3	N/A	IL	N/A	IL
	D	ISO/R2	N/A	IL	N/A	IL
1 : 9 to 18 kg	C	ISO/R3	N/A	IL	N/A	IL
	B	ISO/F2	N/A	IUF, IL	N/A	IUF, IL
	B1	ISO/F2X	N/A	IUF, IL	N/A	IUF, IL
	A	ISO/F3	N/A	IUF, IL	N/A	IUF, IL
	A	ISO/F3	N/A	IUF, IL	N/A	IUF, IL

IUF = Suitable for ISOFIX forward child restraints systems of universal category approved for use in the mass group.

IL = Suitable for particular ISOFIX child restraints systems (CRS) given in the attached list. These ISOFIX CRS are those of the “specific vehicle”, “restricted” or “semi-universal” categories.

X = ISOFIX position not suitable for ISOFIX child restraint system in this mass group and/or this size class.

### ***Installing a child restraint system by lap/shoulder belt***

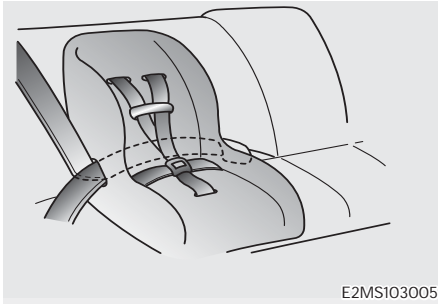

To install a child restraint system on the outboard or center rear seats, do the following:

1. Place the child restraint system in the seat and route the lap/shoulder belt around or through the restraint, following the restraint manufacturer's instructions. Be sure the seat belt webbing is not twisted.



2. Fasten the lap/shoulder belt latch into the buckle. Listen for the distinct "Click" sound.

*Position the release button so that it is easy to access in case of an emergency.*



3. Buckle the seat belt and allow the seat belt to take up any slack. After installation of the child restraint system, try to move it in all directions to be sure the child restraint system is securely installed.

If you need to tighten the belt, pull more webbing toward the retractor. When you unbuckle the seat belt and allow it to retract, the retractor will automatically revert back to its normal seated passenger emergency locking usage condition.

**Child Seat Restraint for Vehicle ISOFIX Positions**

Suitability of each seating position for ISOFIX Child Restraint Systems according to ECE regulations. Use Child Restraint Systems that have been officially approved and are appropriate for your children. When using the Child Restraint Systems, refer to the following table.

Mass Group		Seating Position (or other side)				
		Front Passenger	Rear Outboard	Rear Centre	Immediate Outboard	Immediate Centre
Group 0	Up to 10 kg	X	U	X	-	-
Group 0+	Up to 13 kg	X	U	X	-	-
Group I	9 to 18 kg	X	U	X	-	-
Group II	15 to 25 kg	X	U	X	-	-
Group III	22 to 36 kg	X	U	X	-	-

U = Suitable for “universal” category Child Restraints Systems approved for use in this mass group.

UF = Suitable for forward facing “universal” category restraints for use in this mass group.

X = Seat position not suitable for children in this mass group.

## AIRBAG - SUPPLEMENTAL RESTRAINT SYSTEM (SRS)

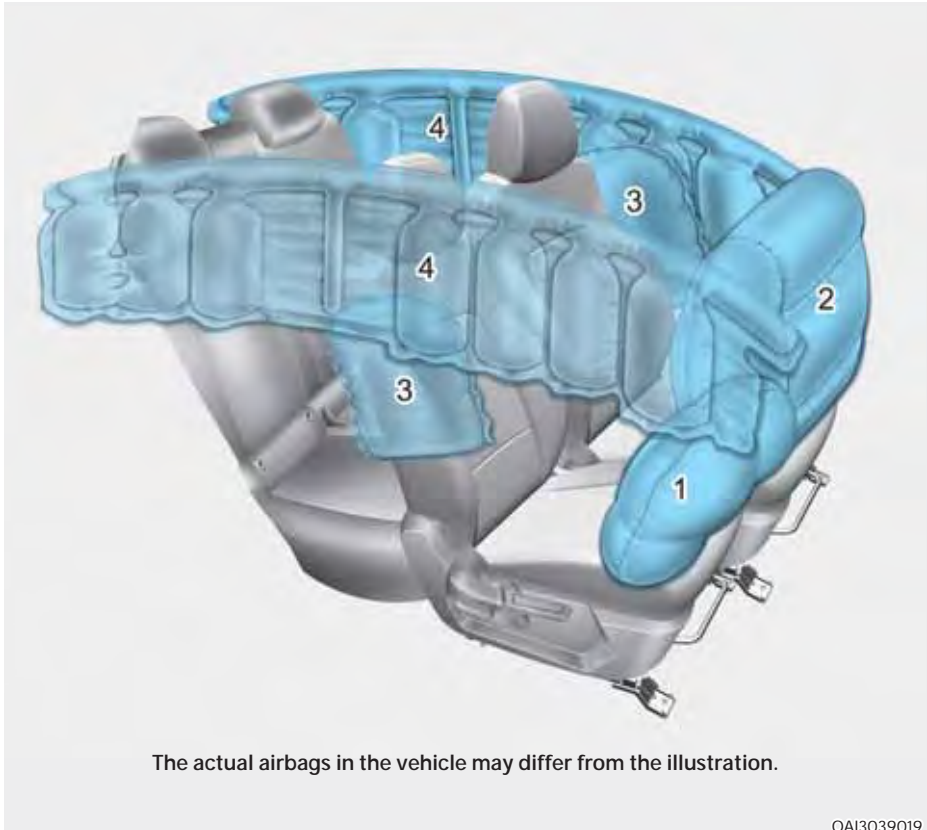

OAI3039019

1. Driver's front airbag
  2. Passenger's front airbag
  3. Side airbag
  4. Curtain airbag\*
- \* : if equipped



## WARNING

- Even in vehicles with airbags, you and your passengers must always wear the safety belts provided in order to minimize the risk and severity of injury in the event of a collision or rollover.
- SRS and pretensioners contain explosive chemicals.  
If scraping a vehicle without removing SRS and pretensioners from a vehicle, it may cause fire. Before scraping a vehicle, we recommend that you contact an authorized HYUNDAI dealer.
- Keep the SRS parts and wirings away from water or any liquid. If the SRS components are inoperative due to exposure to water or liquids, it may cause fire or severe injury.

## How does the airbag system operate

- Airbags are activated (able to inflate if necessary) only when the ignition switch is placed to the ON or START position.
- Airbags inflate instantly in the event of serious frontal or side collision in order to help protect the occupants from serious physical injury.
- There is no single speed at which the airbags will inflate.

Generally, airbags are designed to inflate based upon the severity of a collision and its direction. These two factors determine whether the sensors produce an electronic deployment/inflation signal.

- Airbag deployment depends on a number of factors including vehicle speed, angles of impact and the density and stiffness of the vehicles or objects which your vehicle hits in the collision. The determining factors are not limited to those mentioned above.
- The front airbags will completely inflate and deflate in an instant.

It is virtually impossible for you to see the airbags inflate during an accident.

It is much more likely that you will simply see the deflated airbags hanging out of their storage compartments after the collision.



- In order to help provide protection in a severe collision, the airbags must inflate rapidly. The speed of airbag inflation is a consequence of extremely short time in which a collision occurs and the need to get the airbag between the occupant and the vehicle structures before the occupant impacts those structures. This speed of inflation reduces the risk of serious or life-threatening injuries in a severe collision and is thus a necessary part of airbag design. However, airbag inflation can also cause injuries which can include facial abrasions, bruises and broken bones because the inflation speed also causes the airbags to expand with a great deal of force.
- There are even circumstances under which contact with the steering wheel airbag can cause fatal injuries, especially if the occupant is positioned excessively close to the steering wheel.



## WARNING

- **To avoid severe personal injury or death caused by deploying airbags in a collision, the driver should sit as far back from the steering wheel airbag as possible. The front passenger should always move their seat as far back as possible and sit back in their seat.**
- **Airbag inflates instantly in an event of a collision, passengers may be injured by the airbag expansion force if they are not in a proper position.**
- **Airbag inflation may cause injuries including facial or bodily abrasions, injuries from broken glasses or burns.**

### Noise and smoke

When the airbags inflate, they make a loud noise and they leave smoke and powder in the air inside of the vehicle. This is normal and is a result of the ignition of the airbag inflator. After the airbag inflates, you may feel substantial discomfort in breathing due to the contact of your chest with both the seat belt and the airbag, as well as from breathing the smoke and powder. **Open your doors and/or windows as soon as possible after impact in order to reduce discomfort and prevent prolonged exposure to the smoke and powder.**

Though smoke and powder are non-toxic, it may cause irritation to the skin (eyes, nose and throat, etc.). If this is the case, wash and rinse with cold water immediately and consult with the doctor if the symptom persists.



### WARNING

**When the airbags deploy, the airbag related parts in the steering wheel are very hot. To prevent injury, do not touch the airbag storage area's internal components immediately after an airbag has inflated.**

### Do not install a child restraint on the front passenger's seat (if equipped)



OYDESA2042

Never place a rear-facing child restraint in the front passenger's seat. If the airbag deploys, it would impact the rear-facing child restraint, causing serious or fatal injury.

In addition, do not place front-facing child restraints in the front passenger's seat either. If the front passenger airbag inflates, it would cause serious or fatal injuries to the child.

## WARNING

- NEVER use a rearward facing child restraint on a seat protected by an ACTIVE Airbag in front of it, DEATH or SERIOUS INJURY to the CHILD can occur.
- Never put a child restraint in the front passenger's seat. If the front passenger airbag inflates, it would cause serious or fatal injuries.

## Airbag warning and indicator

### *Airbag warning light*

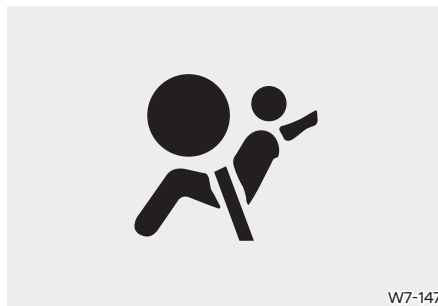

The purpose of the airbag warning light in your instrument panel is to alert you of a potential problem with your airbag - Supplemental Restraint System (SRS).

When the ignition switch is turned ON, the warning light should illuminate for approximately 6 seconds, then go off.

Have the system checked if:

- The light does not turn on briefly when you turn the ignition ON.
- The light stays on after illuminating for approximately 6 seconds.
- The light comes on while the vehicle is in motion.
- The light blinks when the ignition switch is in ON position.

### SRS components and functions

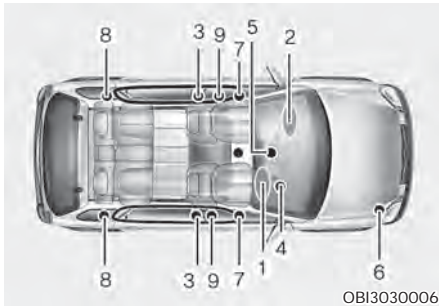

The SRS consists of the following components:

- (1) Driver's front airbag module
- (2) Passenger's front airbag module
- (3) Pre-tensioner seatbelt system
- (4) Airbag warning light
- (5) SRS control module (SRSCM)
- (6) Front impact Sensor
- (7) Side airbag modules
- (8) Curtain airbag modules \*
- (9) Side impact sensors

\* : if equipped

The SRSCM continuously monitors all SRS components while the ignition switch is ON to determine if a crash impact is severe enough to require airbag deployment or pre-tensioner seat belt deployment.

The SRS airbag warning light on the instrument panel will illuminate for about 6 seconds after the ignition switch is turned to the ON position, after which the airbag warning light should go out.

#### **WARNING**

**If any of the following conditions occurs, this indicates a malfunction of the SRS. We recommend that the system be inspected by an authorized HYUNDAI dealer.**

- **The light does not turn on briefly when you turn the ignition ON.**
- **The light stays on after illuminating for approximately 6 seconds.**
- **The light comes on while the vehicle is in motion.**
- **The light blinks when the ignition switch is in ON position.**

■ Driver's front airbag (1)



B240B01L

The airbag modules are located both in the center of the steering wheel and in the front passenger's panel above the glove box. When the SRSCM detects a sufficiently severe impact to the front of the vehicle, it will automatically deploy the front airbags.

■ Driver's front airbag (2)



B240B02L

Upon deployment, tear seams molded directly into the pad covers will separate under pressure from the expansion of the airbags. Further opening of the covers then allows full inflation of the airbags.

■ Driver's front airbag (3)

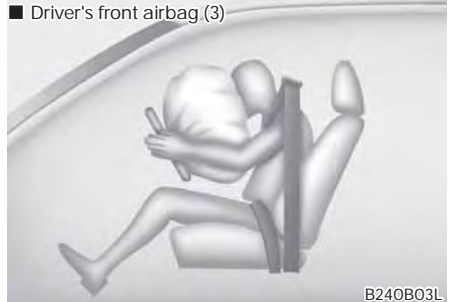

B240B03L

A fully inflated airbag, in combination with a properly worn seat belt, slows the driver's or the passenger's forward motion, reducing the risk of head and chest injury.

After complete inflation, the airbag immediately starts deflating, enabling the driver to maintain forward visibility and the ability to steer or operate other controls.



### WARNING

- Do not install or place any accessories (drink holder, cassette holder, sticker, etc.) on the front passenger's panel above the glove box in a vehicle with a passenger's airbag. Such objects may become dangerous projectiles and cause injury if the passenger's airbag inflates.
- When installing a container of liquid air freshener inside the vehicle, do not place it near the instrument cluster nor on the instrument panel surface.  
It may become a dangerous projectile and cause injury if the passenger's airbag inflates.

### WARNING

- If an airbag deploys, there may be a loud noise followed by a fine dust released in the vehicle. These conditions are normal and are not hazardous - the airbags are packed in this fine powder. The dust generated during airbag deployment may cause skin or eye irritation as well as aggravate asthma for some persons. Always wash all exposed skin areas thoroughly with cold water and a mild soap after an accident in which the airbags were deployed.
- The SRS can function only when the ignition switch is in the ON position.
- Before you replace a fuse or disconnect a battery terminal, turn the ignition switch to the OFF/LOCK position and remove the ignition key. Never remove or replace the airbag related fuse(s) when the ignition switch is in the ON position. Failure to heed this warning will cause the SRS airbag warning light to illuminate.

## Driver's and passenger's front airbag



Your vehicle is equipped with a Supplemental Restraint (Airbag) System and lap/shoulder belts at both the driver and passenger seating positions.

The indications of the system's presence are the letters "Airbag" engraved on the airbag pad cover in the steering wheel and the passenger's side front panel pad above the glove box.

The SRS consists of airbags installed under the pad covers in the center of the steering wheel and the passenger's side front panel above the glove box.

The purpose of the SRS is to provide the vehicle's driver and/or the front passenger with additional protection than that offered by the seat belt system alone in case of a frontal impact of sufficient severity.

### **WARNING**

**Always use seat belts and child restraints – every trip, every time, everyone! Airbags inflate with considerable force and in the blink of an eye. Seat belts help keep occupants in proper position to obtain maximum benefit from the airbag. Even with airbags, improperly and unbelted occupants can be severely injured when the airbag inflates. Always follow the precautions about seat belts, airbags and occupant safety contained in this manual.**

To reduce the chance of serious or fatal injuries and receive the maximum safety benefit from your restraint system:

- Never place a child in any child or booster seat in the front seat.
- ABC – Always Buckle Children in the back seat. It is the safest place for children of any age to ride.
- Airbags can injure occupants improperly positioned in the front seats.
- Move your seat as far back as practical from the front airbags, while still maintaining control of the vehicle.
- You and your passengers should never sit or lean unnecessarily close to the airbags. Improperly positioned drivers and passengers can be severely injured by inflating airbags.

- Never lean against the door or center console – always sit in an upright position.
- No objects (such as crash pad cover, cellular phone holder, cup holder, air fresheners or stickers) should be placed over or near the airbag modules on the steering wheel, instrument panel, windshield glass, and the front passenger's panel above the glove box. Such objects could cause harm if the vehicle is in a crash severe enough to cause the airbags to deploy.
- Do not attach any objects on the front windshield and inside mirror.
- Do not tamper with or disconnect SRS wiring or other components of the SRS system. Doing so could result in injury, due to accidental deployment of the airbags or by rendering the SRS inoperative.
- If the SRS airbag warning light remains illuminated while the vehicle is being driven, we recommend that the system be inspected by an authorized HYUNDAI dealer.
- Airbags can only be used once – we recommend that the system be replaced by an authorized HYUNDAI dealer.
- The SRS is designed to deploy the front airbags only when an impact is sufficiently severe. Additionally, the airbags will only deploy once. Seat belts must be worn at all times.
- Front airbags are not intended to deploy in side-impact, rear-impact or rollover crashes. In addition, front airbags will not deploy in frontal crashes below the deployment threshold.
- A child restraint system must never be placed in the front seat. The infant or child could be severely injured or killed by an airbag deployment in case of an accident.
- Children age 12 and under must always be properly restrained in the rear seat. Never allow children to ride in the front passenger seat. If a child over 12 must be seated in the front seat, move the seat as far back as possible. And the child must always be restrained in the seat properly.
- For maximum safety protection in all types of crashes, all occupants including the driver should always wear their seat belts whether or not an airbag is also provided at their seating position to minimize the risk of severe injury or death in the event of a crash. Do not sit or lean unnecessarily close to the airbag while the vehicle is in motion.
- Sitting improperly or out of position can result in serious or fatal injury in a crash. All occupants should sit upright with the seat back in an upright position, centered on the seat cushion with their seat belt on, legs comfortably extended and their feet on the floor until the vehicle is parked and the ignition key is removed.
- The SRS airbag system must deploy very rapidly to provide protection in a crash. If an occupant is out of position because of not wearing a seat belt, the airbag may forcefully contact the occupant causing serious or fatal injuries.



### Why didn't my airbag go off in a collision? (Inflation and non-inflation conditions of the airbag)

There are many types of accidents in which the airbag would not be expected to provide additional protection.

These include rear impacts, the second or third collisions in multiple impact accidents, as well as low speed impacts.

### Side airbag

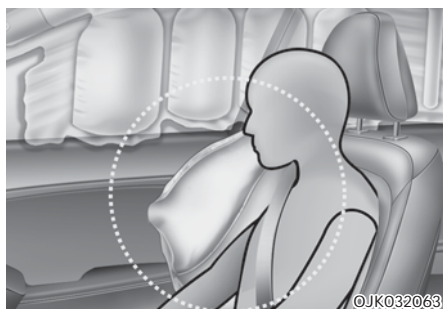

The actual airbags in the vehicle may differ from the illustration.

Your vehicle is equipped with a side airbag in each front seat.

The purpose of the airbag is to provide the vehicle's driver and/or the front passenger with additional protection than that offered by the seat belt alone.

The side airbags are designed to deploy only during certain side-impact collisions, depending on the crash severity, angle, speed and point of impact. The side airbags are not designed to deploy in all side impact situations.

### WARNING

Do not allow the passengers to lean their heads or bodies onto doors, put their arms on the doors, stretch their arms out of the window, or place objects between the doors and passengers when they are seated on seats equipped with side and/or curtain airbags.

### WARNING

- The side airbag is supplemental to the driver's and the passenger's seat belt systems and is not a substitute for them. Therefore, your seat belts must be worn at all times while the vehicle is in motion. The airbags deploy only in certain side impact conditions severe enough to cause significant injury to the vehicle occupants.
- For best protection from the side airbag system and to avoid being injured by the deploying side airbag, both front seat occupants should sit in an upright position with the seat belt properly fastened. The driver's hands should be placed on the steering wheel at the 9:00 and 3:00 positions. The passenger's arms and hands should be placed on their laps.
- Do not use any accessory seat covers.
- Use of seat covers could reduce or prevent the effectiveness of the system.
- Do not install any accessories on the side or near the side airbag.

- Do not place any objects over the airbag or between the airbag and yourself. Also, do not attach any objects around the area the airbag inflates such as the door, side door glass, front and rear pillar.
- Do not place any objects between the door and the seat. They may become dangerous projectiles if the side airbag inflates.
- Do not put any objects between the side airbag label and seat cushion. It could cause harm if the vehicle is in a crash severe enough to cause the airbags to deploy.
- To prevent unexpected deployment of the side airbag that may result in personal injury, avoid impact to the side impact sensor when the ignition switch is on.
- If the seat or seat cover is damaged, we recommend that the system serviced by an authorized HYUNDAI dealer.
- Inform the dealer that your vehicle is equipped with side airbags.

### Curtain airbag (if equipped)



The actual airbags in the vehicle may differ from the illustration.

Curtain airbags are located along both sides of the roof rails above the front and rear doors.

They are designed to help protect the heads of the front seat occupants and the rear outboard seat occupants in certain side impact collisions.

The curtain airbags are designed to deploy only during certain side impact collisions, depending on the crash severity, angle, speed and impact.

The curtain airbags are not designed to deploy in all side impact situations, collisions from the front or rear of the vehicle or in most rollover situations.



## WARNING

- In order for side impact and curtain airbags to provide the best protection, both front seat occupants and both outboard rear occupants should sit in an upright position with the seat belts properly fastened.

Importantly, children should sit in a proper child restraint system in the rear seat.

- When children are seated in the rear outboard seats, they must be seated in the proper child restraint system. Make sure to put the child restraint system as far away from the door side as possible, and secure the child restraint system in a locked position.
- Do not place any objects over the airbag. Also, do not attach any objects around the area the airbag inflates such as the door, side door glass, front and rear pillars, roof side rail.
- Do not hang other objects except clothes, especially hard or breakable objects. In an accident, it may cause vehicle damage or personal injury.
- Do not allow the passengers to lean their heads or bodies onto doors, put their arms on the doors, stretch their arms out of the window, or place objects between the doors and passengers when they are seated on seats equipped with side and/or curtain airbags.
- Do not attempt to open or repair the side curtain airbags yourself. If necessary, we recommend that the airbag be inspected by an authorized HYUNDAI dealer.
- Never try to open or repair any components of the side curtain airbag system. We recommend that the system be serviced by an authorized HYUNDAI dealer.

Failure to follow the above mentioned instructions can result in injury or death to the vehicle occupants in an accident.

Why didn't my airbag go off in a collision? (Inflation and non-inflation conditions of the airbag)

There are many types of accidents in which the airbag would not be expected to provide additional protection.

These include rear impacts, the second or third collisions in multiple impact accidents, as well as low speed impacts.

### Airbag inflation conditions

■ 5 Door



OAI3032022/OAI3039024/OAI3033023L/OBI3030014L

(1) SRS control module

(2) Front impact sensor

(3) Side impact sensor\*

\* : if equipped

## ■ 4 Door



OAI3032042/OAI3039024/OAI3033043L/OBI3030014L

- (1) SRS control module
  - (2) Front impact sensor
  - (3) Side impact sensor\*
- \* : if equipped

 **WARNING**

- Do not hit or allow any objects to impact the locations where airbags or sensors are installed.  
This may cause unexpected airbag deployment, which could result in serious personal injury or death.
- If the installation location or angle of the sensors is altered in any way, the airbags may deploy when they should not or they may not deploy when they should, causing severe injury or death.

Therefore, do not try to perform maintenance on or around the airbag sensors. We recommend that the system be serviced by an authorized HYUNDAI dealer.

- Problems may arise if the sensor installation angles are changed due to the deformation of the front bumper and body. We recommend that the system be serviced by an authorized HYUNDAI dealer.
- Your vehicle has been designed to absorb impact and deploy the airbag(s) in certain collisions. Installing aftermarket bumper guards or replacing a bumper with non-genuine parts may adversely affect your vehicles collision and airbag deployment performance.

*Airbag inflation conditions*



**Front airbags**

Front airbags are designed to inflate in certain frontal collision depending on the crash severity, speed or angles of impact of the front collision.

If the vehicle chassis is impacted by bumps or objects on unimproved roads or sidewalks, airbags may deploy. Drive carefully on unimproved roads or on surfaces not designed for vehicle traffic to prevent unintended airbag deployment.



©AI3032028

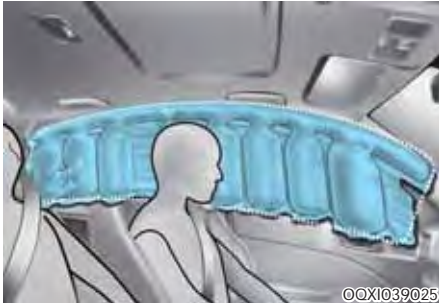

©CXI039025

### Side airbags (if equipped)

Side airbags (side impact and/or curtain airbags) are designed to inflate when an impact is detected by side collision sensors depending on the crash severity, speed or angles of impact resulting from a side impact collision.

Although the front airbags (driver's and front passenger's airbags) are designed to inflate only in frontal collisions, they also may inflate in other types of collisions if the front impact sensor detects a sufficient impact. Side airbags (side impact and/or curtain airbags) are designed to inflate only in side impact collisions, but they may inflate in other collisions if the side impact sensors detect a sufficient impact.

If the vehicle chassis is impacted by bumps or objects on unimproved roads or sidewalks, airbags may deploy. Drive carefully on unimproved roads or on surfaces not designed for vehicle traffic to prevent unintended airbag deployment.

### Airbag non-inflation conditions



©AI3039026

- In certain low-speed collisions, the airbags may not deploy. The airbags are designed not to deploy in such cases because they may not provide benefits beyond the protection of the seat belts in such collisions.



©AI3039027

- Front airbags are not designed to inflate in rear collisions, because occupants are moved backward by the force of the impact. In this case, inflated airbags would not be able to provide any additional benefit.



- Front airbags may not inflate in side impact collisions, because occupants move to the direction of the collision, and thus in side impacts, frontal airbag deployment would not provide additional occupant protection.



- In a slant or angled collision, the force of impact may direct the occupants in a direction where the airbags would not be able to provide any additional benefit, and thus the sensors may not deploy any airbags.



- Just before impact, drivers often brake heavily. Such heavy braking lowers the front portion of the vehicle causing it to “ride” under a vehicle with a higher ground clearance. Airbags may not inflate in this “under-ride” situation because deceleration forces that are detected by sensor may be significantly reduced by such “under-ride” collisions.



- Airbags do not inflate in rollover accidents because the vehicle can not detect rollover accident. However, side and/or curtain airbags may inflate when the vehicle is rolled over after side impact collision.





- Airbags may not inflate if the vehicle collides with objects such as utility poles or trees, where the point of impact is concentrated and the collision energy is absorbed by the vehicle structure.

## SRS Care

The SRS is virtually maintenance free and so there are no parts you can safely service by yourself. If the SRS airbag warning light does not illuminate approximately 6sec after ignition switch turned ON, or continuously remains on, we recommend that the system be inspected by an authorized HYUNDAI dealer.

We recommend that the any work on the SRS system, such as removing, installing or repairing, or any work on the steering wheel, the front passenger's panel, front seats or roof rails be performed by an authorized HYUNDAI dealer. Improper handling of the SRS system may result in serious personal injury.

### WARNING

- Modification to SRS components or wiring, including the addition of any kind of badges to the pad covers or modifications to the body structure, can adversely affect SRS performance and lead to possible injury.
- For cleaning the airbag pad covers, use only a soft, dry cloth or one which has been moistened with plain water. Solvents or cleaners could adversely affect the airbag covers and proper deployment of the system.

- No objects should be placed over or near the airbag modules on the steering wheel, instrument panel, and the front passenger's panel above the glove box, because any such object could cause harm if the vehicle is in a crash severe enough to cause the airbags to inflate.
- If the airbags inflate, we recommend that the system be replaced by an authorized HYUNDAI dealer.
- Do not tamper with or disconnect SRS wiring, or other components of the SRS system. Doing so could result in injury, due to accidental inflation of the airbags or by rendering the SRS inoperative.
- If components of the airbag system must be discarded, or if the vehicle must be scrapped, certain safety precautions must be observed. An authorized HYUNDAI dealer knows these precautions and can give you the necessary information. Failure to follow these precautions and procedures could increase the risk of personal injury.
- If your car was flooded and has soaked carpeting or water on the flooring, you shouldn't try to start the engine; we recommend that you contact an authorized HYUNDAI dealer.

### Additional safety precautions

- **Never let passengers ride in the cargo area or on top of a folded-down back seat.** All occupants should sit upright, fully back in their seats with their seat belts on and their feet on the floor.
- **Passengers should not move out of or change seats while the vehicle is moving.** A passenger who is not wearing a seat belt during a crash or emergency stop can be thrown against the inside of the vehicle, against other occupants, or out of the vehicle.
- **Each seat belt is designed to restrain one occupant.** If more than one person uses the same seat belt, they could be seriously injured or killed in a collision.
- **Do not use any accessories on seat belts.** Devices claiming to improve occupant comfort or reposition the seat belt can reduce the protection provided by the seat belt and increase the chance of serious injury in a crash.
- **Passengers should not place hard or sharp objects between themselves and the airbags.** Carrying hard or sharp objects on your lap or in your mouth can result in injuries if an airbag inflates.
- **Keep occupants away from the airbag covers.** All occupants should sit upright, fully back in their seats with their seat belts on and their feet on the floor. If occupants are too close to the airbag covers, they could be injured if the airbags inflate.

- **Do not attach or place objects on or near the airbag covers.** Any object attached to or placed on the front airbag covers could interfere with the proper operation of the airbags.
- **Do not modify the front seats.** Modification of the front seats could interfere with the operation of the supplemental restraint system sensing components in the airbags.
- **Do not place items under the front seats.** Placing items under the front seats could interfere with the operation of the supplemental restraint system sensing components and wiring harnesses.
- **Never hold an infant or child on your lap.** The infant or child could be seriously injured or killed in the event of a crash. All infants and children should be properly restrained in appropriate child safety seats or seat belts in the rear seat.



## WARNING

- **Sitting improperly or out of position can cause occupants to be shifted too close to a deploying airbag, strike the interior structure or be thrown from the vehicle resulting in serious injury or death.**
- **Always sit upright with the seatback in an upright position, centered on the seat cushion with your seat belt on, legs comfortably extended and your feet on the floor.**

### *Adding equipment to or modifying your airbag-equipped vehicle*

If you modify your vehicle by changing your vehicle's frame, bumper system, front end or side sheet metal or ride height, this may affect the operation of your vehicle's airbag system.

### Airbag warning label



Airbag warning labels are attached to alert the driver and passengers of potential risks of the airbag system. Be sure to read all of the information about the airbags that are installed on your vehicle in this Owner's Manual.

# 4. Instrument Cluster

Instrument cluster .....	4-2
Gauges .....	4-4
Instrument cluster control .....	4-4
Transmission shift indicator .....	4-9
Warning and indicator lights .....	4-10
Cluster display messages .....	4-19
Cluster display (cluster type B) .....	4-23
Cluster display control .....	4-23
Cluster display modes .....	4-24
User settings mode .....	4-26
Trip computer .....	4-30
Cluster type A .....	4-30
Cluster type B .....	4-35

## INSTRUMENT CLUSTER

■ Type A



OAI3043001

1. Tachometer
2. Speedometer
3. Fuel gauge
4. Warning and indicator lights
5. Trip mode/reset button

The actual cluster in the vehicle may differ from the illustration.  
For more details, refer to the “Gauges” in this chapter.

## ■ Type B



OAI3043033

1. Tachometer
2. Speedometer
3. Engine coolant temperature gauge
4. Fuel gauge
5. Warning and indicator lights
6. Cluster display (including Trip computer)

**The actual cluster in the vehicle may differ from the illustration. For more details, refer to the “Gauges” in this chapter.**

### Instrument Cluster Control



#### WARNING

Never adjust the instrument cluster while driving. This could result in loss of control and lead to an accident that may cause death, serious injury, or property damage.

### Gauges

#### Speedometer

■ Type A



OAI3049003

■ Type B



OAI3042032

The speedometer indicates the speed of the vehicle and is calibrated in kilometers per hour (km/h).



## Tachometer

### ■ Type A



OAI3049005

### ■ Type B



OJS048103

The tachometer indicates the approximate number of engine revolutions per minute (RPM).

Use the tachometer to select the correct shift points and to prevent lugging and/ or over-revving the engine.

## NOTICE

Do not operate the engine within the tachometer's RED ZONE. This may cause severe engine damage.

## Fuel Gauge

### ■ Type A

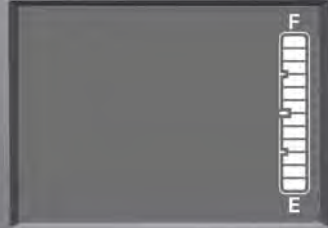

OAI3049007

### ■ Type B



OJS048103

This gauge indicates the approximate amount of fuel remaining in the fuel tank.

**i** Information

- The fuel tank capacity is given in chapter 2.
- The fuel gauge is supplemented by a low fuel warning light, which will illuminate when the fuel tank is nearly empty.
- On inclines or curves, the fuel gauge pointer may fluctuate or the low fuel warning light may come on earlier than usual due to the movement of fuel in the tank.

**⚠** WARNING

Running out of fuel can expose vehicle occupants to danger.

You must stop and obtain additional fuel as soon as possible after the warning light comes on or when the gauge indicator comes close to the “E (Empty)” level.

**NOTICE**

Avoid driving with a very low fuel level. Running out of fuel could cause the engine to misfire damaging the catalytic converter.

*Engine Coolant Temperature Gauge (if equipped)*



This gauge shows the temperature of the engine coolant when the ignition switch is in the ON position.

**NOTICE**

If the gauge pointer moves beyond the normal range area toward the “H” position, it indicates overheating that may damage the engine.

Do not continue driving with an overheated engine. If your vehicle overheats, refer to the “If the Engine Overheats” in chapter 8.

**⚠** WARNING

Never remove the radiator cap or reservoir cap when the engine is hot. The engine coolant is under pressure and could cause severe burns. Wait until the engine is cool before adding coolant to the reservoir.

## Odometer



The odometer indicates the total distance that the vehicle has been driven and should be used to determine when periodic maintenance should be performed.

- Odometer range : 0 ~ 1599999 kilometers or 999999 miles.

## **i** Information

It is forbidden to alter the odometer of all vehicles with the intent to change the mileage registered on the odometer. The alteration may void your warranty coverage.

### Outside Temperature Gauge

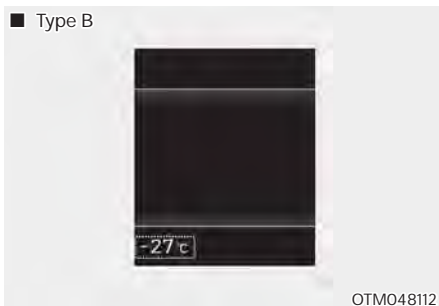

This gauge indicates the current outside air temperatures by 1 °C (1 °F).

- Temperature range : -40 °C ~ 85 °C (-40 °F ~ 211 °F)

The outside temperature on the display may not change immediately like a general thermometer to prevent the driver from being inattentive.

You can change the temperature unit (from °C to °F or from °F to °C) in the press the TRIP button for more than 5 seconds on the Cluster. (Type A, B, if equipped)

The temperature unit (from °C to °F or from °F to °C) can be changed as below procedures. (Type C, if equipped)

- User Settings Mode in the Cluster : You can change the temperature unit in the "Other Features – Temperature unit".

## Transmission Shift Indicator

### Automated manual transmission Shift Indicator (if equipped)

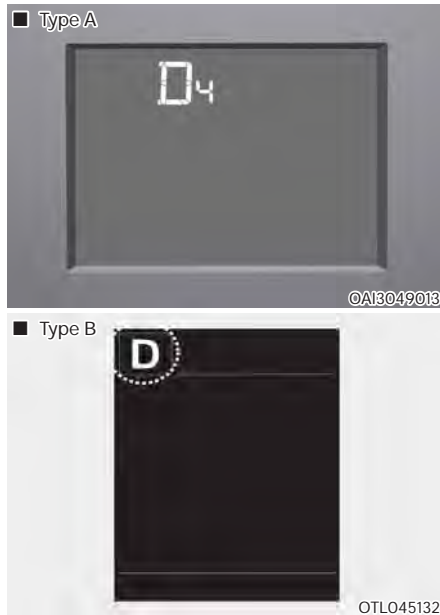

This indicator displays which Automated Manual Transmission shift lever is selected.

- Park : P
- Reverse : R
- Neutral : N
- Drive : D1, D2, D3, D4, D5
- Manual Mode : 1, 2, 3, 4, 5

### Manual transmission Shift Indicator (if equipped)



This indicator informs which gear is recommended while driving, to save fuel.

- Shifting up : ▲ 2, ▲ 3, ▲ 4, ▲ 5
- Shifting down : ▼1, ▼2, ▼3, ▼4

For example

- ▲3: Indicates that shifting up to the 3rd gear is recommended (currently the shift lever is in the 2nd or 1st gear).
- ▼3: Indicates that shifting down to the 3rd gear is recommended (currently the shift lever is in the 4th or 5th gear).

When the system is not working properly, the indicator is not displayed.

## Warning and indicator lights

### Information

**Make sure that all warning lights are OFF after starting the engine. If any light is still ON, this indicates a situation that needs attention.**

#### *Airbag Warning Light (if equipped)*



#### **This warning light illuminates:**

- Once you set the ignition switch or Engine Start/Stop button to the ON position.
  - It illuminates for approximately 6 seconds and then goes off.
- When there is a malfunction with the SRS.

In this case, we recommend that you have the vehicle inspected by an authorized HYUNDAI dealer.

### ***Seat Belt Warning Light***



This warning light informs the driver (or front passenger) that the seat belt is not fastened.

For more details, refer to the “Seat Belts” in chapter 3.

### ***Parking Brake & Brake Fluid Warning Light***



#### **This warning light illuminates:**

- Once you set the ignition switch or Engine Start/Stop button to the ON position.
  - It illuminates for approximately 3 seconds
  - It remains on if the parking brake is applied.
- When the parking brake is applied.
- When the brake fluid level in the reservoir is low.
  - If the warning light illuminates with the parking brake released, it indicates the brake fluid level is low.

#### **If the brake fluid level in the reservoir is low:**

1. Drive carefully to the nearest safe location and stop your vehicle.
2. With the engine stopped, check the brake fluid level immediately and add fluid as required (For more details, refer to “Brake Fluid” in chapter 9). Then check all brake components for fluid leaks. If any leak on the brake system is still found, the warning light remains on, or the brakes do not operate properly, do not drive the vehicle.

In this case, we recommend that you have the vehicle towed to an authorized HYUNDAI dealer and inspected.

#### **Dual-diagonal braking system**

Your vehicle is equipped with dual-diagonal braking systems. This means you still have braking on two wheels even if one of the dual systems should fail.

With only one of the dual systems working, more than normal pedal travel and greater pedal pressure are required to stop the vehicle.

Also, the vehicle will not stop in as short a distance with only a portion of the brake system working.

If the brakes fail while you are driving, shift to a lower gear for additional engine braking and stop the vehicle as soon as it is safe to do so.



## WARNING

### Parking Brake & Brake Fluid Warning Light

Driving the vehicle with a warning light ON is dangerous. If the Parking Brake & Brake Fluid Warning Light illuminates with the parking brake released, it indicates that the brake fluid level is low.

In this case, we recommend that you have the vehicle inspected by an authorized HYUNDAI dealer.

### Anti-lock Brake System (ABS) Warning Light



#### This warning light illuminates:

- Once you set the ignition switch or Engine Start/Stop button to the ON position.
  - It illuminates for approximately 3 seconds and then goes off.
- When there is a malfunction with the ABS (The normal braking system will still be operational without the assistance of the anti-lock brake system).

In this case, we recommend that you have the vehicle inspected by an authorized HYUNDAI dealer.

### Motor Driven Power Steering (MDPS) Warning Light (if equipped)



#### This warning light illuminates:

- Once you set the ignition switch or Engine Start/Stop button to the ON position.
  - It illuminates for approximately 3 seconds and then goes off.
- When there is a malfunction with the MDPS.

In this case, we recommend that you have the vehicle inspected by an authorized HYUNDAI dealer.

### Malfunction Indicator Lamp (MIL)



#### This warning light illuminates:

- Once you set the ignition switch or Engine Start/Stop button to the ON position.
  - It illuminates for approximately 3 seconds and then goes off.
- When there is a malfunction with the emission control system.

In this case, we recommend that you have the vehicle inspected by an authorized HYUNDAI dealer.



**NOTICE**

- Malfunction Indicator Lamp (MIL)
- Driving with the Malfunction Indicator Lamp (MIL) on may cause damage to the emission control systems which could effect drivability and/or fuel economy.

**NOTICE**

If the Malfunction Indicator Lamp (MIL) illuminates, potential catalytic converter damage is possible which could result in loss of engine power. In this case, we recommend that you have the vehicle inspected by an authorized HYUNDAI dealer as soon as possible.

**Charging System  
Warning Light****This warning light illuminates:**

- Once you set the ignition switch or Engine Start/Stop button to the ON position.
  - It remains on until the engine is started.
- When there is a malfunction with either the alternator or electrical charging system.

**If there is a malfunction with either the alternator or electrical charging system:**

1. Drive carefully to the nearest safe location and stop your vehicle.
2. Turn the engine off and check the alternator drive belt for looseness or breakage.

If the belt is adjusted properly, there may be a problem in the electrical charging system.

In this case, we recommend that you have the vehicle inspected by an authorized HYUNDAI dealer as soon as possible.

**Engine Oil Pressure  
Warning Light****This warning light illuminates:**

- Once you set the ignition switch or Engine Start/Stop button to the ON position.
  - It remains on until the engine is started.
- When the engine oil pressure is low.

**If the engine oil pressure is low:**

1. Drive carefully to the nearest safe location and stop your vehicle.
2. Turn the engine off and check the engine oil level (For more details, refer to "Engine Oil" in chapter 9). If the level is low, add oil as required.

If the warning light remains on after adding oil or if oil is not available, we recommend that you have the vehicle inspected by an authorized HYUNDAI dealer as soon as possible.

Continued driving with the warning light on may cause engine failure.

**NOTICE**

- If the engine does not stop immediately after the Engine Oil Pressure Warning Light is illuminated, severe damage could result.
- If the warning light stays on while the engine is running, it indicates that there may be serious engine damage or malfunction. In this case,
  1. Stop the vehicle as soon as it is safe to do so.
  2. Turn off the engine and check the oil level. If the oil level is low, fill the engine oil to the proper level.
  3. Start the engine again. If the warning light stays on after the engine is started, turn the engine off immediately. In this case, we recommend that you have the vehicle inspected by an authorized HYUNDAI dealer.

**Engine has Overheated  
Warning Light**



This warning light illuminates with a warning chime when the engine coolant temperature is above 120°C (248°F). It remains on if the engine coolant temperature is above 120°C (248°F). This means that the engine is overheated and may be damaged.

If your vehicle is overheated, refer to “If the Engine Overheats” in chapter 8.

**Low Fuel Level Warning  
Light**



**This warning light illuminates:**

When the fuel tank is nearly empty.

If the fuel tank is nearly empty, add fuel as soon as possible.

**NOTICE**

**Low Fuel Level**

Driving with the Low Fuel Level warning light on or with the fuel level below “E (Empty)” can cause the engine to misfire and damage the catalytic converter (if equipped).

### ***Electronic Stability Control (ESC) Indicator Light (if equipped)***



#### **This indicator light illuminates:**

- When you set the ignition switch to the ON position.
  - It illuminates for approximately 3 seconds and then goes off.
- When there is a malfunction with the ESC system.

In this case, we recommend that you have the vehicle inspected by an authorized HYUNDAI dealer.

#### **This indicator light blinks:**

- While the ESC is operating.

For more details, refer to “Electronic Stability Control (ESC)” in chapter 6.

### ***Electronic Stability Control (ESC) OFF Indicator Light (if equipped)***



#### **This indicator light illuminates:**

- When you set the ignition switch to the ON position.
  - It illuminates for approximately 3 seconds and then goes off.
- When you deactivate the ESC system by pressing the ESC OFF button.

For more details, refer to “Electronic Stability Control (ESC)” in chapter 6.

### ***Door Ajar Warning Light***



#### **This warning light illuminates:**

When a door is not close securely.

### ***Tailgate/Trunk Open Warning Light***



#### **This warning light illuminates:**

When the tailgate/trunk is not close securely.

### ***Hood Open Warning Light***



#### **This warning light illuminates:**

When the hood is not close securely.

### ***Immobilizer Indicator Light (without smart key) (if equipped)***



#### **This indicator light illuminates:**

When the vehicle detects the immobilizer in your key properly while the ignition switch is ON.

- At this time, you can start the engine.
- The indicator light goes off after starting the engine.

#### **This indicator light blinks:**

When there is a malfunction with the immobilizer system.

In this case, we recommend that you have the vehicle inspected by an authorized HYUNDAI dealer.

**Immobilizer Indicator Light (with smart key) (if equipped)**



**This indicator light illuminates for up to 30 seconds:**

When the vehicle detects the smart key in the vehicle properly while the Engine Start/Stop button is ACC or ON.

- At this time, you can start the engine.
- The indicator light goes off after starting the engine.

**This indicator light blinks for a few seconds:**

When the smart key is not in the vehicle.

- At this time, you can not start the engine.

**This indicator light illuminates for 2 seconds and goes off:**

When the vehicle can not detect the smart key which is in the vehicle while the Engine Start/Stop button is ON.

In this case, we recommend that you have the vehicle inspected by an authorized HYUNDAI dealer.

**This indicator light blinks:**

- When the battery of the smart key is weak.
  - At this time, you can not start the engine. However, you can start the engine if you press the Engine Start/Stop button with the smart key. (For more details, refer to “Starting the Engine” in chapter 6).

- When there is a malfunction with the immobilizer system.

In this case, we recommend that you have the vehicle inspected by an authorized HYUNDAI dealer.

**Turn Signal Indicator Light**

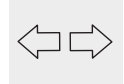

**This indicator light blinks:**

When you turn the turn signal light on.

If any of the following occurs, there may be a malfunction with the turn signal system. In this case, we recommend that you have the vehicle inspected by an authorized HYUNDAI dealer.

- The indicator light does not blink but illuminates.
- The indicator light blinks more rapidly.
- The indicator light does not illuminate at all.

**High Beam Indicator Light****This indicator light illuminates:**

- When the headlights are on and in the high beam position
- When the turn signal lever is pulled into the Flash-to-Pass position.

**Light ON Indicator Light****This indicator light illuminates:**

When the Parking (Position) lights or headlights are on.

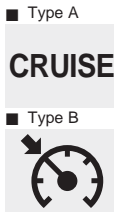
**Cruise Indicator Light (if equipped)****This indicator light illuminates:**

When Cruise Control system is enabled.

For more details, refer to “Cruise Control” in chapter 7.

**Master Warning Light (if equipped)****This indicator light illuminates :**

- Tire Pressure Monitoring System malfunction (if equipped)

To identify the details of the warning, look at the cluster display.

**Cruise SET Indicator Light (if equipped)**

SET

**This indicator light illuminates:**

- When the cruise control speed is set.

For more details, refer to “Cruise Control” in chapter 7.

**KEY OUT Indicator Light (if equipped)**

KEY  
OUT

When the Engine Start/Stop button is in the ACC or ON position, if any door is open, the system checks for the smart key.

**This indicator light blinks:**

When the smart key is not in the vehicle and any door is open with the ignition switch or the Engine Start/Stop button in the ACC or ON position.

- At this time, if you close all doors, the chime will also sound for approximately 5 seconds.
- The indicator will go off while the vehicle is moving.

**Press Brake  
(for Automated Manual  
Transmission)**



**This indicator light illuminates :**

- When changing gear position with out pressing brake pedal
- When trying to start the engine without pressing brake pedal

**Parking Brake Engaged  
(for Automated Manual  
Transmission)**



**This indicator light illuminates :**

When engine is turned off without engaging parking brake lever it illuminates for approx. 5 seconds then goes off

**Clutch Over Heated  
(for Automated Manual  
Transmission) (if  
equipped)**



**This indicator light illuminates :**

When clutch estimated temperature rise up to limited value

**Low Tire Pressure  
Warning Light  
(if equipped)**



**This warning light illuminates:**

- When you set the ignition switch or the Engine Start/Stop button to the ON position.
  - It illuminates for approximately 3 seconds and then goes off.
- When one or more of your tires are significantly underinflated (The location of the underinflated tire is displayed on the Cluster display).

For more details, refer to “Tire Pressure Monitoring System (TPMS)” section in chapter 8.

**This warning light remains on after blinking for approximately 60 seconds or repeatedly blinks on and off at approximately 3 second intervals:**

- When there is a malfunction with the TPMS.

In this case, we recommend that you have the vehicle inspected by an authorized HYUNDAI dealer as soon as possible.

For more details, refer to “Tire Pressure Monitoring System (TPMS)” section in chapter 8.

 **WARNING**

**Safe Stopping**

- The TPMS cannot alert you to severe and sudden tire damage caused by external factors.
- If you notice any vehicle instability, immediately take your foot off the accelerator pedal, apply the brakes gradually with light force, and slowly move to a safe position off the road.

## Cluster display messages (if equipped)

### ***Key not in vehicle (for smart key system)***

This warning message is displayed if the smart key is not in the vehicle when you open or close door in the ACC position or ON position. The warning sound is heard when you close door without a smart key in vehicle.

When attempting to start the vehicle always have the smart key with you.

### ***Press START button with key (for smart key system)***

This warning message is displayed if you press the Engine Start/Stop button while the warning message “Key not detected” is displayed.

At this time, the immobilizer indicator light blinks.

### ***Low key battery (for smart key system)***

This warning message is displayed if the battery of the smart key is discharged while changing the Engine Start/Stop button to the OFF position.

### ***Press brake pedal to start engine (for smart key system and Automated manual transmission)***

This warning message is displayed if the Engine Start/Stop button changes to the ACC position twice by pressing the button repeatedly without depressing the brake pedal.

You can start the vehicle by depressing the brake pedal.

### ***Press clutch pedal to start engine (for smart key system and Manual transmission)***

This warning message is displayed if the Engine Start/Stop button is in the ACC position twice by pressing the button repeatedly without depressing the clutch pedal.

Depress the clutch pedal to start the engine.

### ***Press START button again (for smart key system)***

This message is displayed if you were unable to start the vehicle when the Engine Start/Stop button was pressed.

If this occurs, attempt to start the engine by pressing the Engine Start/Stop button again.

If the warning message appears each time you press the Engine Start/Stop button, we recommend that you have your vehicle inspected by an authorized HYUNDAI dealer.

***Shift to N to start engine  
(for smart key system and  
Automated manual transmission)***

This warning message is displayed if you try to start the engine with the shift button not in the N (Neutral) position.

***i* Information**

**You can start the engine with the shift lever in the N (Neutral) position.**

***Check BRAKE SWITCH fuse (for  
smart key system and Automated  
manual transmission)***

This warning message is displayed if the brake switch fuse is disconnected.

You need to replace the fuse with a new one. If that is not possible, you can start the engine by pressing the Engine Start/Stop button for 10 seconds in the ACC position.

***Turn on FUSE SWITCH***

This warning message is displayed if the fuse switch located on the fuse box under the steering wheel is OFF.

You should turn the fuse switch on.

**For more details, refer to “Fuses” Section in chapter 9.**



***Low pressure (if equipped)***

This warning message is displayed if the tire pressure is low. The corresponding tire on the vehicle will be illuminated.

For more details, refer to “Tire Pressure Monitoring System (TPMS)” section in chapter 8.

***Heated Steering Wheel turned off (if equipped)***

This message illuminates if the heated steering wheel will turn off automatically approximately 30 minutes after the heated steering wheel is turned on.

For more details, refer to “Heated Steering Wheel” in chapter 5.

***Low fuel***

This warning message is displayed if the fuel tank is almost out of fuel.

When this message is displayed, the low fuel level warning light in the cluster will come on.

It is recommended to look for the nearest fueling station and refuel as soon as possible.

***Low engine oil (if equipped)***

This warning message is displayed when the engine oil level should be checked.

If this warning message is displayed, check the engine oil level as soon as possible and add engine oil as required.

Slowly pour the recommended oil little by little into a funnel.

Use only the specified engine oil. (Refer to “Recommended lubricants and capacities” section in chapter 2.)

Do not overfill the engine oil. Make sure the oil level is not above F (Full) mark on the dipstick.

**NOTICE**

If the message is displayed continuously after adding the engine oil and travelling approximately 50-100 km after the engine warms up, we recommend that the system be checked by an authorized HYUNDAI dealer.

### ***Engine has overheated (if equipped)***

This warning message is displayed when the engine coolant temperature is above 120 °C (248 °F). This means that the engine is overheated and may be damaged.

**If your vehicle is overheated, refer to “Overheating” section in chapter 8.**

### ***Check headlight (if equipped)***

This warning message is displayed if the headlamps are not operating properly.

In addition, if a specific lamp (turn signal lamp etc.) is not operating properly, the warning message according to a specific lamp (turn signal lamp etc.) is displayed. A corresponding bulb may need to be replaced.

Make sure to replace the burned out bulb with a new one of the same wattage rating.

### ***Check brake light (if equipped)***

This warning message is displayed if the stop lamps are not operating properly. A lamp may need to be replaced.

Make sure to replace the burned out bulb with a new one of the same wattage rating.

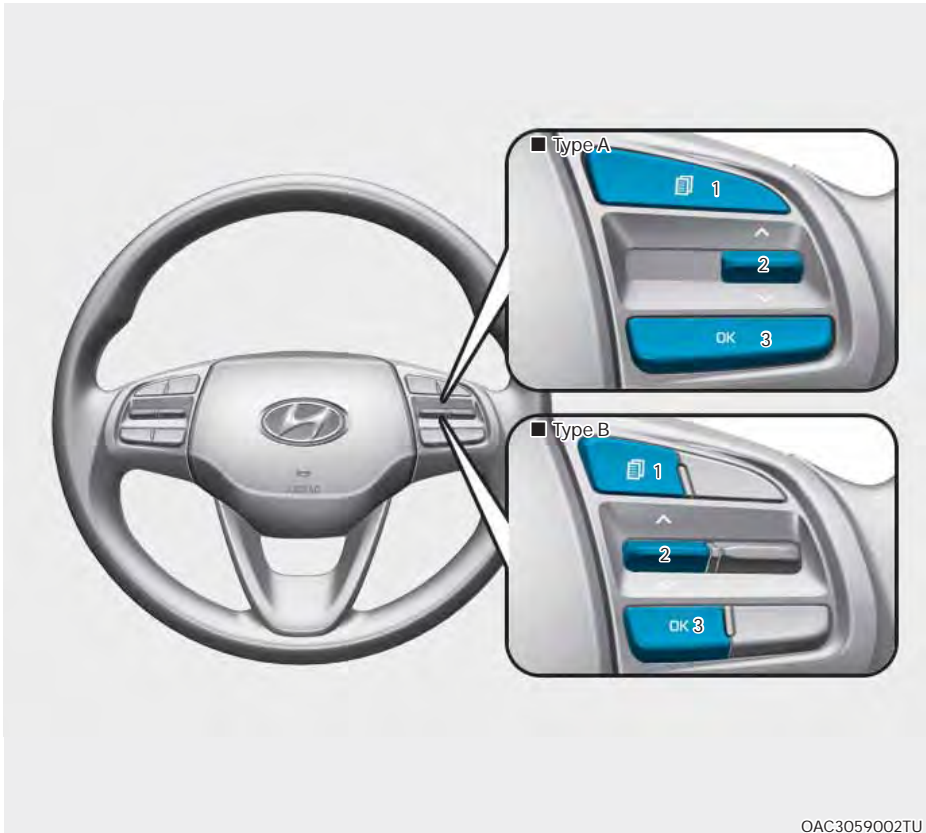

## CLUSTER DISPLAY (CLUSTER TYPE B) (IF EQUIPPED)

### Cluster display control







OAC3059002TU

The Cluster display modes can be changed by using the control buttons.

- (1) : MODE button for changing modes
- (2) , : MOVE switch for changing items
- (3) OK: SELECT/RESET button for setting or resetting the selected item

## Cluster display modes

Modes	Symbol	Explanation
Trip Computer		This mode displays driving information such as the tripmeter, fuel economy, etc. For more details, refer to "Trip Computer" in this chapter.
Driving Assist		Tire Pressure Monitoring System
User Settings		In this mode, you can change settings of the doors, lamps and etc.
Warning		- This mode displays warning messages related to the lamp malfunction, etc. - Tire pressure information

The information provided may differ depending on which functions are applicable to your vehicle.

### *Trip computer mode*



The trip computer mode displays information related to vehicle driving parameters including fuel economy, tripmeter information and vehicle speed.

For more details, refer to "Trip Computer" in this chapter.

### *Driving Assist mode*



#### **Tire Pressure**

This mode displays information related to Tire Pressure.

For more details, refer to "Tire Pressure Monitoring System (TPMS)" in chapter 8.

### Master warning



This warning light informs the driver the following situations.

- Tire Pressure Monitoring System malfunction (if equipped)

The Master Warning Light illuminates if one or more of the above warning situations occur.

At this time, a Master Warning icon () will appear beside the User Settings icon () on the Cluster display.

If the warning situation is solved, the master warning light will be turned off and the Master Warning icon will disappear.

### User settings mode

In this mode, you can change the settings of the instrument cluster, doors, lamps, etc.

1. Driver Assistance
2. Door
3. Light
4. Convenience
5. Service Interval
6. Other
7. Language
8. Reset

**The information provided may differ depending on which functions are applicable to your vehicle.**

#### **Shift to P to edit settings/Engage parking brake to edit settings**

This warning message illuminates if you try to select an item from the User Settings mode while driving.

- Automated manual transmission  
For your safety, change the User Settings after parking the vehicle, applying the parking brake and moving the shift lever to P(Park).
- Manual transmission  
For your safety, change the User Settings after engaging the parking brake.

#### **Quick guide (Help)**

This mode provides quick guides for the systems in the User Settings mode.

Select an item, press and hold the OK button.

**For more details about each system, refer to this Owner's Manual.**

### *User settings mode*

In this mode, you can change setting of the instrument cluster, doors, lamps, and so on.

#### **Driver Assistance (if equipped)**

Items	Explanation
Driving Assist	The function assists the driver to maintain the set speed, keep a safe distance with a vehicle ahead and keep the vehicle inside of the lane while driving on the highway.
Warning Volume	To adjust the warning volume of the driver assistance system. • High / Medium / Low

#### **Door**

Items	Explanation
Auto Lock	<ul style="list-style-type: none"> <li>• Disable : The auto door lock operation will be deactivated.</li> <li>• Enable on Speed : All doors will be automatically locked when the vehicle speed exceeds 15 km/h (9.3 mph).</li> </ul>
Auto Unlock	<ul style="list-style-type: none"> <li>• Disable : The auto door unlock operation will be canceled.</li> <li>• Vehicle Off: All doors will be automatically unlocked when the ignition key is removed from the ignition switch or the Engine Start/Stop button is set to the OFF position.</li> </ul>

#### **Light**

Items	Explanation
One Touch Turn Signal	<ul style="list-style-type: none"> <li>• Off: The one touch turn signal function will be deactivated.</li> <li>• 3 Flashes : The lane change signals will blink 3 times when the turn signal lever is moved slightly.</li> </ul> <p><b>For more details, refer to "Lighting" in chapter 5.</b></p>
Ambient Light	To activate or deactivate the Ambient Light (cabin mood light setting) function.
Head Lamp Delay	<ul style="list-style-type: none"> <li>• Off: The headlight delay function will be deactivated.</li> <li>• On: The headlight delay function will be activated.</li> </ul> <p><b>For more details, refer to "Lighting" in chapter 5.</b></p>

**Service interval**

Items	Explanation
Service Interval	<p>In this mode, you can activate the service interval function with mileage (km or mi.) and period (months).</p> <ul style="list-style-type: none"> <li>• Off: The service interval function will be deactivated.</li> <li>• On: You can set the service interval (mileage and months).</li> </ul>

**Other features**

Items	Explanation
Fuel Economy Auto Reset	<ul style="list-style-type: none"> <li>• Off: The average fuel economy will not reset automatically whenever refueling.</li> <li>• After Ignition: The average fuel economy will reset automatically whenever it has passed 4 hours after turning OFF the engine.</li> <li>• After Refueling: The average fuel economy will reset automatically when refueling.</li> </ul> <p><b>For more details, refer to “Trip Computer” in this chapter.</b></p>
Fuel Economy Unit	Choose the fuel economy unit. (Km/L, L/100km) (US gallon, UK gallon)
Temperature Unit	Choose the temperature unit. (°C, °F)



**Language**

Items	Explanation
Language	Choose the language.

**Reset**

Items	Explanation
Reset	You can reset the menus in the User Settings Mode. All menus in the User Settings Mode are reset to factory settings, except language and service interval.

**NOTICE**

The information provided may differ depending on which functions are applicable to your vehicle.

## TRIP COMPUTER

### Cluster type A (if equipped)

#### *Tripmeter/Trip computer*



The trip computer is a microcomputer-controlled driver information system that displays information related to driving, when the ignition switch is in the ON position. All stored driving information (except odometer & Trip A & B) resets if the battery is disconnected.

Press the trip mode/reset button for less than 1 second to select any mode as follows:

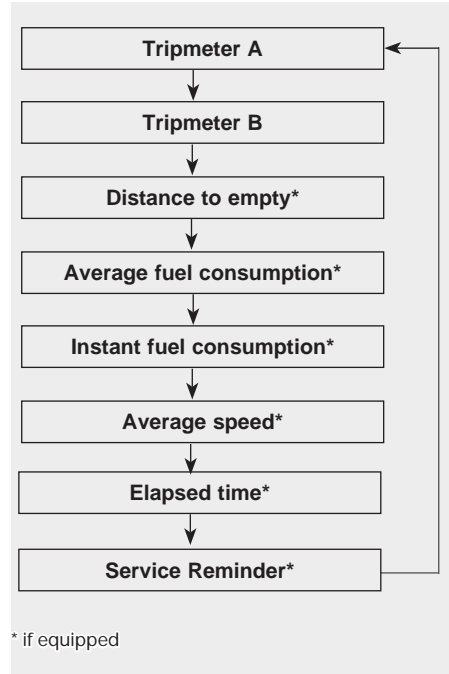



©AH2043107

### **Tripmeter (km or mi.)**

A : Tripmeter A

B : Tripmeter B

This mode indicates the distance of individual trips selected since the last tripmeter reset.

The meter's working range is from 0.0 to 9999.9 km. (0.0 to 9999.9 miles). Pressing the trip mode/reset button for more than 1 second, when the tripmeter is being displayed, clears the tripmeter to zero (0.0).



©AH2043103

### **Distance to empty (if equipped) (km or mi.)**

This mode indicates the estimated distance to empty based on the current fuel in the fuel tank and the amount of fuel delivered to the engine. When the remaining distance is below 50 km (30 miles), "---" will be displayed.

The meter's working range is from 50 to 999 km (30 to 615 miles).



**Average fuel consumption  
(if equipped) (l/100 km or MPG)**

This mode calculates the average fuel consumption from the total fuel used and the distance since the last average consumption reset. The total fuel used is calculated from the fuel consumption input. For an accurate calculation, drive more than 300 m (0.18 miles).

Pressing the RESET button for more than 1 second, when the average fuel consumption is being displayed, clears the average fuel consumption to zero (---).



**Instant fuel consumption  
(if equipped) (l/100 km or MPG)**

This mode calculates the instant fuel consumption of the last few seconds.

**NOTICE**

- If the vehicle is not on level ground or the battery power has been interrupted, the “Distance to empty” function may not operate correctly. The trip computer may not register additional fuel if less than 6 liters (1.6 gallons) of fuel are added to the vehicle.
- The fuel consumption and distance to empty may vary significantly based on driving conditions, driving habits, and condition of the vehicle.
- The distance to empty value is an estimate of the available driving distance. This may differ from the actual driving distance available.

**Average speed (km/h or MPH)**

This mode calculates the average speed of the vehicle since the last average speed reset.

Even if the vehicle is not in motion, the average speed keeps going while the engine is running.

Pressing the RESET button for more than 1 second, when the average speed is being displayed, clear the average speed to zero (---).



**Elapsed time (if equipped)**

This mode indicates the total time traveled since the last driving time reset.

Even if the vehicle is not in motion, the driving time keeps going while the engine is running.

The meter's working range is from 00:00-99:59.

Pressing the RESET button for more than 1 second, when the driving time is being displayed, clear the driving time to zero (00:00).

**Service reminder**



This mode displays the service interval (mileage).

## Cluster type B (if equipped)

The trip computer is a microcomputer-controlled driver information system that displays information related to driving.

### **i** Information

Some driving information stored in the trip computer (for example, Average Vehicle Speed) resets if the battery is disconnected.

### *Trip modes*

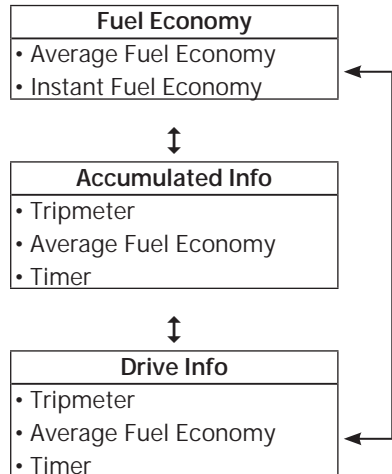

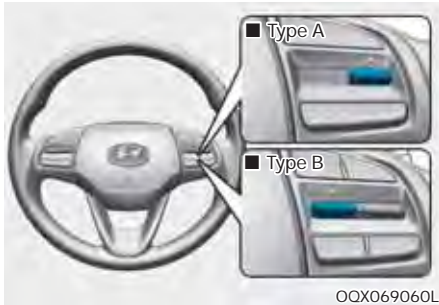

To change the trip mode, toggle the “^, v” switch on the steering wheel.

### Fuel economy



#### Average Fuel Economy (1)

- The average fuel economy is calculated by the total driving distance and fuel consumption since the last average fuel economy reset.
- The average fuel economy can be reset both manually and automatically.

#### Manual reset

To clear the average fuel economy manually, press the [OK] button on the steering wheel for more than 1 second when the average fuel economy is displayed.

#### Automatic reset

To automatically reset the average fuel economy after refueling, select the “Fuel Econ. Reset” mode in the User Settings menu on the Cluster display.

- After ignition: The average fuel economy will reset automatically whenever it has passed 4 hours after turning OFF the engine.
- After refueling: The average fuel economy will reset automatically when driving speed exceeds 1 km/h, after adding 6 liters (1.6 gallons) of fuel or more.

### Information

**The average fuel economy may be inaccurate, when the vehicle drives shorter than 300 meters (0.19 miles) after turning ON the Engine Start/Stop button.**

#### Instant Fuel Economy (2)

- This mode displays the instant fuel economy during the last few seconds when the vehicle speed is more than 10 km/h (6.2 mph).



## Accumulated Info

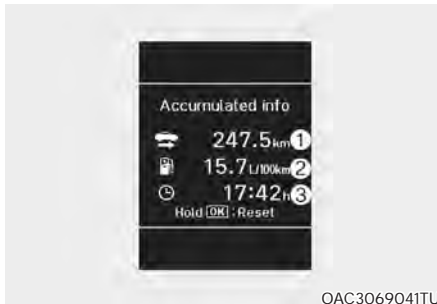

This display shows the accumulated trip distance (1), the average fuel economy (2), and the total driving time (3).

The information is accumulated starting from the last reset.

To manually reset the information, press and hold the OK button when viewing the Accumulated driving info. The trip distance, the average fuel economy, and total driving time will reset simultaneously.

The accumulated driving information will continue to be counted while the engine is still running (for example, when the vehicle is in traffic or stopped at a stop light).

### Information

**The vehicle must be driven for a minimum of 300 meters (0.19 miles) since the last ignition key cycle before the average fuel economy will be recalculated.**

### Drive Info



This display shows the trip distance (1), the average fuel economy (2), and the total driving time (3).

The information is combined for each ignition cycle. However, when the engine has been OFF for 4 hours or longer the Drive Info screen will reset.

To manually reset the information, press and hold the OK button when viewing the Drive Info. The trip distance, the average fuel economy, and total driving time will reset simultaneously.

The driving information will continue to be counted while the engine is still running (for example, when the vehicle is in traffic or stopped at a stop light.)

### **i** Information

**The vehicle must be driven for a minimum of 300 meters (0.19 miles) since the last ignition key cycle before the average fuel economy will be recalculated.**

# 5. Convenience Features

Accessing your vehicle .....	5-4
Remote key .....	5-4
Remote key precautions .....	5-6
Smart key .....	5-7
Smart key precautions .....	5-11
Immobilizer system .....	5-12
Door locks.....	5-14
Operating door locks from outside the vehicle.....	5-14
Operating door locks from inside the vehicle .....	5-16
Auto door lock/unlock features.....	5-18
Child-protector rear door locks.....	5-18
Steering wheel .....	5-19
Motor driven power steering (MDPS) .....	5-19
Tilt steering .....	5-20
Horn.....	5-21
Mirrors .....	5-22
Inside rearview mirror.....	5-22
Outside rearview mirror.....	5-23
Windows .....	5-25
Power windows .....	5-25
Manual windows .....	5-28
Exterior features.....	5-29
Hood.....	5-29
Tailgate.....	5-30
Trunk.....	5-32
Fuel filler door.....	5-33
Lighting.....	5-36
Exterior lights.....	5-36
Interior lights .....	5-40
Wipers and washers.....	5-43
Windshield wipers.....	5-44
Windshield washers .....	5-44
Rear window wiper and washer switch .....	5-45
Manual climate control system.....	5-46
Heating and air conditioning.....	5-47
System operation .....	5-51
System maintenance .....	5-53

Automatic climate control system.....	5-55
Automatic heating and air conditioning .....	5-56
Manual heating and air conditioning .....	5-57
System operation .....	5-62
System maintenance .....	5-64
Windshield defrosting and defogging.....	5-65
Manual climate control system .....	5-65
Automatic climate control system .....	5-66
Defroster .....	5-67
Storage compartment .....	5-69
Center console storage.....	5-69
Glove box .....	5-70
Cool box.....	5-70
Interior features .....	5-71
Clock .....	5-71
Cup holder .....	5-71
Sunvisor .....	5-72
Power outlet .....	5-72
USB charger.....	5-73
Coat hook.....	5-74
Floor mat anchor(s).....	5-74
Cargo area cover (5 Door).....	5-75
Exterior features.....	5-75
Roof rack.....	5-75
Infotainment system.....	5-76
USB port.....	5-76
Antenna.....	5-76
Steering wheel audio control .....	5-77
Audio/Video.....	5-78
Bluetooth® Wireless Technology hands-free.....	5-79
How vehicle audio works.....	5-79

# 5. Convenience Features

Audio (without touch screen).....	5-82
System layout – control panel.....	5-82
System layout – steering wheel remote control .....	5-86
Turning the system on or off.....	5-88
Turning the display on or off.....	5-89
Getting to know the basic operations.....	5-89
Radio.....	5-90
Turning on the radio .....	5-90
Changing the radio mode.....	5-93
Scanning for available radio stations.....	5-93
Saving radio stations.....	5-94
Listening to saved radio stations.....	5-94
Media player.....	5-95
Using the media player .....	5-95
Using the USB mode.....	5-95
Bluetooth.....	5-98
Connecting Bluetooth devices.....	5-98
Using a Bluetooth audio device .....	5-101
Using a Bluetooth phone .....	5-103
The emergency call service.....	5-108
System status icons .....	5-109
Infotainment system specifications .....	5-110
USB.....	5-110
Bluetooth .....	5-111
Trademarks.....	5-111
Declaration of conformity .....	5-112
CE .....	5-112
IFETEL .....	5-113
TRA .....	5-113

## ACCESSING YOUR VEHICLE

### Remote key (if equipped)



Your HYUNDAI uses a remote key, which you can use to lock or unlock a door (and trunk/tailgate) and even start the engine.

1. Door Lock
2. Door Unlock
3. Trunk/Tailgate Unlock

#### **Locking**

To lock :

1. Close all doors, engine hood and trunk/tailgate.
2. Press the Door Lock button (1) on the remote key.
3. The doors will lock. The hazard warning lights will blink once.
4. Make sure the doors are locked by checking the position of the door lock button inside the vehicle.



#### **WARNING**

**Do not leave the keys in your vehicle with unsupervised children. Unattended children could place the key in the ignition switch and may operate power windows or other controls, or even make the vehicle move, which could result in serious injury or death.**

#### **Unlocking**

To unlock:

1. Press the Door Unlock button (2) on the remote key.
2. The doors will unlock. The hazard warning lights will blink two times.



#### **Information**

**After unlocking the doors, the doors will lock automatically after 30 seconds unless a door is opened.**

#### **Trunk/Tailgate unlocking**

To unlock:

1. Press the Trunk/Tailgate Unlock button (3) on the remote key for more than one second.
2. The hazard warning lights will blink two times. Once the tailgate/trunk is opened and then closed, the tailgate/trunk will lock automatically.



#### **Information**

- **After unlocking the tailgate, the tailgate will lock automatically.**
- **The word “HOLD” is written on the button to inform you that you must press and hold the button for more than one second.**

### Start-up

For detailed information, refer to “Key Ignition Switch” in chapter 6.

#### NOTICE

To prevent damaging the remote key:

- Keep the remote key away from water or any liquid and fire. If the inside of the remote key gets damp (due to drinks or moisture), or is heated, the internal circuit may malfunction, excluding the car from the warranty.
- Avoid dropping or throwing the remote key.
- Protect the remote key from extreme temperatures.

### Mechanical key

#### ■ Type A



#### ■ Type B



If the remote key does not operate normally, you can lock or unlock the door by using the mechanical key.

#### Type B

To unfold the key, press the release button then the key will unfold automatically.

To fold the key, fold the key manually while pressing the release button.

#### NOTICE

**Do not fold the key without pressing the release button. This may damage the key.**

### Remote key precautions

The remote key will not work if any of the following occurs:

- The key is in the ignition switch.
- You exceed the operating distance limit (about 10 m [30 feet]).
- The remote key battery is weak.
- Other vehicles or objects may be blocking the signal.
- The weather is extremely cold.
- The remote key is close to a radio transmitter such as a radio station or an airport which can interfere with normal operation of the remote key.

When the remote key does not work correctly, open and close the door with the mechanical key. If you have a problem with the remote key, it is recommended that you contact an authorized HYUNDAI dealer.

If the remote key is in close proximity to your mobile phone, the signal could be blocked by your mobile phone's normal operational signals. This is especially important when the phone is active such as making and receiving calls, text messaging, and/or sending/receiving emails. Avoid placing the remote key and your mobile phone in the same pants or jacket pocket and always try to maintain an adequate distance between the two devices.

### **i** Information

**Changes or modifications not expressly approved by the party responsible for compliance could void the user's authority to operate the equipment. If the keyless entry system is inoperative due to changes or modifications not expressly approved by the party responsible for compliance, it will not be covered by your manufacturer's vehicle warranty.**

### **NOTICE**

**Keep the remote key away from electromagnetic materials that blocks electromagnetic waves to the key surface.**

### *Battery replacement*

If the remote key is not working properly, try replacing the battery with a new one.



### **Type A**

Battery type: CR2032

To replace the battery:

1. Insert a slim tool into the slot and gently pry open the cover.
2. Remove the old battery and insert the new battery. Make sure the battery position is correct.
3. Reinstall the rear cover of the remote key.



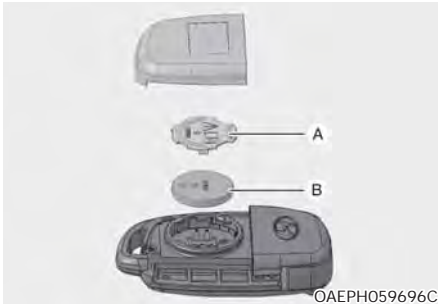

OAEPH059696C

### Type B

Battery type: CR2032

To replace the battery:

1. Insert a slim tool into the slot and gently pry open the cover.
2. Using a screw driver remove the battery cover (A).
3. Remove the old battery (B) and insert a new battery. Make sure the battery position is correct.
4. Reinstall the battery cover and key cover in the reverse order of removal.

If you suspect your remote key might have sustained some damage, or you feel your remote key is not working correctly, it is recommended that you contact an authorized HYUNDAI dealer.



### WARNING

**THIS PRODUCT CONTAINS A BUTTON BATTERY.**

If swallowed, a lithium button battery can cause severe or fatal injuries within 2 hours. Keep batteries out of reach of children.

If you think batteries may have been swallowed or placed inside any part of the body, seek immediate medical attention.

### **i** Information



An inappropriately disposed battery can be harmful to the environment and human health. Dispose the battery according to your local law(s) and regulation.

### Smart key (if equipped)

■ Type A



OIB044179

Your HYUNDAI uses a Smart Key, which you can use to lock or unlock a door (and trunk/tailgate) and even start the engine.

1. Door Lock
2. Door Unlock
3. Trunk/Tailgate Unlock

### Locking



To lock :

1. Close all doors, engine hood and tailgate/trunk.
2. Either press the door handle button or press the Door Lock button (1) on the smart key.
3. The hazard warning lights will blink once.
4. Make sure the doors are locked by checking the position of the door lock button inside the vehicle.

### **i** Information

**The door handle button will only operate when the smart key is within 0.7~1 m (28~40 in.) from the outside door handle.**

Even though you press the outside door handle button, the doors will not lock and the chime will sound for three seconds if any of the following occurs:

- The Smart Key is in the vehicle.
- The Engine Start/Stop button is in ACC or ON position.
- Any door except the tailgate/trunk is open.

### **!** WARNING

**Do not leave the Smart Key in your vehicle with unsupervised children. Unattended children could press the Engine Start/Stop button and may operate power windows or other controls, or even make the vehicle move, which could result in serious injury or death.**

## Unlocking



To unlock:

1. Carry the Smart Key.
2. Either press the door handle button or press the Door Unlock button (2) on the smart key.
3. The doors will unlock. The hazard warning lights will blink two times.

### **i** Information

- **The door handle button will only operate when the smart key is within 1 m (40 in.) from the outside door handle. Other people can also open the doors without the smart key in possession.**
- **After unlocking the doors, the doors will lock automatically after 30 seconds unless a door is opened.**

## Tailgate/Trunk unlocking

To unlock:

1. Carry the smart key.
2. Press the Tailgate/Trunk Unlock button (3) on the smart key for more than one second.
3. The hazard warning lights will blink two times.

Once the tailgate/trunk is opened and then closed, the tailgate/trunk will lock automatically.

### **i** Information

**After unlocking the tailgate/trunk, the tailgate/trunk will lock automatically after 30 seconds unless the tailgate/trunk is opened.**

### ***Start-up***

You can start the engine without inserting the key. For detailed information, refer to the Engine Start/Stop button in chapter 6.

#### **NOTICE**

To prevent damaging the smart key:

- **Keep the smart key away from water or any liquid and fire. If the inside of the smart key gets damp (due to drinks or moisture), or is heated, the internal circuit may malfunction, excluding the car from the warranty.**
- **Avoid dropping or throwing the smart key.**
- **Protect the smart key from extreme temperatures.**

#### **NOTICE**

**Always have the smart key with you when leaving the vehicle. If the smart key is placed near the vehicle, the vehicle battery may be discharged.**

### ***Mechanical key***

If the Smart Key does not operate normally, you can lock or unlock the door by using the mechanical key.



OIBO44175

Press and hold the release button (1) and remove the mechanical key (2). Insert the mechanical key into the key hole on the door.

To reinstall the mechanical key, put the key into the hole and push it until a click sound is heard.

### ***Loss of a smart key***

A maximum of two smart keys can be registered to a single vehicle. If you happen to lose your smart key, it is recommended that you should immediately take the vehicle and remaining key to your authorized HYUNDAI dealer or tow the vehicle if necessary.

## Smart key precautions

The smart key will not work if any of the following occurs:

- The smart key is close to a radio transmitter such as a radio station, military area, police station, government offices, broadcasting stations, transmission towers, port or an airport which can interfere with normal operation of the smart key.
- The smart key is near a mobile two way radio system or a cellular phone.
- The smart key is close to a metal product or coins
- Another vehicle's smart key is being operated close to your vehicle.
- When you connect an external device to the multi-purpose socket or USB port and place it near the smart key, the smart key may not be recognized/work in some areas of the vehicle. In this case, try moving the smart key to another location to start the engine or press the start button directly with the smart key to start the engine.
- If your windows are tinted, especially with metallic window tint, it may cause frequency interference, reducing the smart key operating range.
- Make sure the smart key battery is inserted in the correct polarity before use. Using an improperly positioned battery may cause smart key failure or premature discharge of the battery.

In the following situations, the frequency band from the smart key may be mixed with a different frequency, which may cause smart key malfunction (engine operation, door lock function, etc.) or the working distance of smart key may change.

- The smart key is placed near the electronic systems (woofer, cellular phone, portable wired/wireless charger, electric heating device, electronic power bank, e-cigarettes, etc.)

When the smart key does not work correctly, open and close the door with the mechanical key. If you have a problem with the smart key, it is recommended that you contact an authorized HYUNDAI dealer.

If the smart key is in close proximity to your mobile phone, the signal could be blocked by your mobile phone's normal operational signals. This is especially important when the phone is active such as making and receiving calls, text messaging, and/or sending/receiving emails. Avoid placing the smart key and your mobile phone in the same pants or jacket pocket and always try to maintain an adequate distance between the two devices.

### Information

**Changes or modifications not expressly approved by the party responsible for compliance could void the user's authority to operate the equipment. If the keyless entry system is inoperative due to changes or modifications not expressly approved by the party responsible for compliance, it will not be covered by your manufacturer's vehicle warranty.**

### **NOTICE**

**Keep the smart key away from electromagnetic materials that blocks electromagnetic waves to the key surface.**

### Battery replacement



If the Smart Key is not working properly, try replacing the battery with a new one.

Battery Type: CR2032

To replace the battery:

1. Pry open the rear cover of the smart key.
2. Remove the old battery and insert the new battery. Make sure the battery position is correct.
3. Reinstall the rear cover of the smart key.

If you suspect your smart key might have sustained some damage, or you feel your smart key is not working correctly, it is recommended that you contact an authorized HYUNDAI dealer.



### WARNING

**THIS PRODUCT CONTAINS A BUTTON BATTERY.**

**If swallowed, a lithium button battery can cause severe or fatal injuries within 2 hours. Keep batteries out of reach of children.**

**If you think batteries may have been swallowed or placed inside any part of the body, seek immediate medical attention.**

### Information



**An inappropriately disposed battery can be harmful to the environment and human health. Dispose the battery according to your local law(s) and regulation.**

### Immobilizer system

The system is designed in such a way that it makes vehicle theft difficult if its circuit and battery connection is uninterrupted. If an improperly coded key (or other device) is used, the engine's fuel system is disabled.

When the ignition switch is placed in the ON position, the immobilizer system indicator should come on briefly, then go off. If the indicator starts to blink, the system does not recognize the coding of the key.

Place the ignition switch to the LOCK/OFF position, then place the ignition switch to the ON position again.

The system may not recognize your key's coding if another immobilizer key or other metal object (for example, key chain) is near the key. The engine may not start because the metal may interrupt the transponder signal from transmitting normally.

If the system repeatedly does not recognize the coding of the key, it is recommended that you contact your HYUNDAI dealer.

Do not attempt to alter this system or add other devices to it. Electrical problems could result that may make your vehicle inoperable.

### Disclaimer:

The system is designed in such a way that it makes vehicle theft difficult if its circuit and battery connection is uninterrupted.

 **WARNING**

In order to prevent theft of your vehicle, do not leave spare keys anywhere in your vehicle. Your immobilizer password is a customer unique password and should be kept confidential.

**NOTICE**

The transponder in your key is an important part of the immobilizer system. It is designed to give years of trouble-free service, however you should avoid exposure to moisture, static electricity and rough handling. Immobilizer system malfunction could occur.

**Disclaimer:**

The system is designed in such a way that it makes vehicle theft difficult if its circuit and battery connection is uninterrupted.

## DOOR LOCKS

### Operating door locks from outside the vehicle

#### Mechanical key



Turn the key toward the rear of the vehicle to unlock and toward the front of the vehicle to lock.

If you lock/unlock the driver's door with a key, all vehicle doors will lock/unlock automatically. (If equipped with the central door lock system)

Once the doors are unlocked, they may be opened by pulling the door handle.

When closing the door, push the door by hand. Make sure that doors are closed securely.

#### Remote key



To lock the doors, press the Door Lock button (1) on the remote key.

To unlock the doors, press the Door Unlock button (2) on the remote key.

Once the doors are unlocked, they may be opened by pulling the door handle.

When closing the door, push the door by hand. Make sure that doors are closed securely.

#### **i** Information

- **In cold and wet climates, door lock and door mechanisms may not work properly due to freezing conditions.**
- **If the door is locked/unlocked multiple times in rapid succession with either the vehicle key or door lock switch, the system may stop operating temporarily in order to protect the circuit and prevent damage to system components.**



## Smart key



OAI3059062

1. Door lock
2. Door unlock

To lock the doors, press the button on the outside door handle while carrying the smart key with you or press the door lock button on the smart key.

To unlock the doors, press the button on the outside door handle while carrying the smart key with you or press the door unlock button on the smart key.

Once the doors are unlocked, they may be opened by pulling the door handle.

When closing the door, push the door by hand. Make sure that doors are closed securely.

## **i** Information

- In cold and wet climates, door lock and door mechanisms may not work properly due to freezing conditions.
- If the door is locked/unlocked multiple times in rapid succession with either the vehicle key or door lock switch, the system may stop operating temporarily in order to protect the circuit and prevent damage to system components.

## Operating door locks from inside the vehicle

*With the door lock button*



- To unlock a door, push the door lock button (1) to the “Unlock” position.
- To lock a door, push the door lock button (1) to the “Lock” position.
- To open a door, pull the door handle (2) outward.
- If the inner door handle of the driver’s door is pulled when the door lock button is in the lock position, the button is unlocked and door opens.
- Front doors cannot be locked if the key is in the ignition switch and any front door is open.
- Doors cannot be locked if the smart key is in the vehicle and any door is open.

## **i** Information

If a power door lock ever fails to function while you are in the vehicle, try one or more of the following techniques to exit:

**Operate the door unlock feature repeatedly (both electronic and manual) while simultaneously pulling on the door handle.**

**Operate the other door locks and handles, front and rear.**

**Lower a front window and use the mechanical key to unlock the door from outside.**

*With the central door lock/unlock switch*



When pressing the (🔒) portion (1) of the switch, all vehicle doors will lock.

- If the key is in the ignition switch and any door is opened, the doors will not lock even though the lock button (1) of the central door lock switch is pressed.
- If the smart key is in the vehicle and any door is opened, the doors will not lock even though the lock button (1) of the central door lock switch is pressed.

When pressing the (🔓) portion (2) of the switch, all vehicle doors will unlock.

**⚠️ WARNING**

- **The doors should always be fully closed and locked while the vehicle is in motion. If the doors are unlocked, the risk of being thrown from the vehicle in a crash will increase.**
- **Do not pull the inner door handle of the driver's or passenger's door while the vehicle is moving.**

**⚠️ WARNING**

**Do not leave the elderly, children or animals unattended in your vehicle. An enclosed vehicle can become extremely hot, causing death or serious injury to the elderly, unattended children or animals who cannot escape from the vehicle. Children might operate features of the vehicle that could injure them, or they could encounter other harm, possibly from someone gaining entry to the vehicle.**

**⚠️ WARNING**

**Always secure your vehicle.**

**Leaving your vehicle unlocked increases the potential risk to you or others from someone hiding in your vehicle.**

**To secure your vehicle, while depressing the brake, move the shift lever to the P (Park) position (for Automated Manual Transmission) or first gear or R (Reverse, for manual transmission), engage the parking brake, and place the ignition switch in the LOCK/OFF position, close all windows, lock all doors, and always take the key with you.**

 **WARNING**

Opening a door when something is approaching may cause damage or injury. Be careful when opening doors and watch for vehicles, motorcycles, bicycles or pedestrians approaching the vehicle in the path of the door.

 **WARNING**

If you stay in the vehicle for a long time while the weather is very hot or cold, there are risks of injuries or danger to life. Do not lock the vehicle from the outside when someone is in the vehicle.

**Auto door lock/unlock features (if equipped)**

***Impact sensing door unlock system***

All doors will be automatically unlocked when an impact causes the airbags to deploy.

***Speed sensing door lock system***

All doors will be automatically locked when the vehicle speed exceeds 15 km/h (9 mph).

**Child-protector rear door locks**



The child safety lock is provided to help prevent children seated in the rear from accidentally opening the rear doors. The rear door safety locks should be used whenever children are in the vehicle.

The child safety lock is located on the edge of each rear door. When the child safety lock is in the lock position (🔒), the rear door will not open if the inner door handle is pulled.

To lock the child safety lock, insert a key (or screwdriver) into the hole (1) and turn it to the lock (🔒) position.

To allow a rear door to be opened from inside the vehicle, unlock the child safety lock.

 **WARNING**

**If children accidentally open the rear doors while the vehicle is in motion, they could fall out of the vehicle. The rear door safety locks should always be used whenever children are in the vehicle.**

## STEERING WHEEL

### Motor driven power steering (MDPS)

The system assists you with steering the vehicle. If the engine is off or if the power steering system becomes inoperative, the vehicle may still be steered, but it will require increased steering effort.

Also, the steering effort becomes heavier as the vehicle's speed increases and becomes lighter as the vehicle's speed decreases for better control of the steering wheel.

Should you notice any change in the effort required to steer during normal vehicle operation, we recommend that the system be checked by an authorized HYUNDAI dealer.

#### **NOTICE**

If the Motor driven power steering system does not operate normally, the warning light (⚠) will illuminate on the instrument cluster. The steering wheel may become difficult to control or operate. Take your vehicle to an authorized HYUNDAI dealer and have the system checked as soon as possible.

#### **i** Information

The following symptoms may occur during normal vehicle operation:

- The steering effort may be high immediately after placing the ignition switch in the ON position.

This happens as the system performs the MDPS system diagnostics. When the diagnostics is completed, the steering wheel will return to its normal condition.

- When the battery voltage is low, you might have to put more steering effort. However, it is a temporary condition so that it will return to normal condition after charging the battery.
- A click noise may be heard from the MDPS relay after the ignition switch is placed to the ON or LOCK/OFF position.
- Motor noise may be heard when the vehicle is at stop or at a low driving speed.
- When you operate the steering wheel in low temperature, abnormal noise may occur. If temperature rises, the noise will disappear. This is a normal condition.

#### **⚠** WARNING

Never adjust the steering wheel while driving. You may lose the steering control and cause severe personal injury, death or accidents.

## Tilt steering (if equipped)



### WARNING

Never adjust the steering wheel while driving. You may lose steering control and cause severe personal injury, death or accidents.



### Information

After adjustment, sometimes the lock-release lever may not lock the steering wheel.

**It is not a malfunction. This occurs when two gears are not engaged correctly. In this case, adjust the steering wheel again and then lock the steering wheel.**



To change the steering wheel angle:

1. Pull down the lock-release lever (1).
2. Adjust the steering wheel to the desired angle (2). Move the steering wheel, so it points toward your chest, not toward your face. Make sure you can see the instrument panel warning lights and gauges.
3. Pull up the lock-release lever (3) to lock the steering wheel in place.

Push the steering wheel both up and down to be certain it is locked in position.



### CAUTION

**While adjusting the steering wheel height, please do not push or pull it hard since the fixture can be damaged.**

## Horn



To sound the horn, press the area indicated by the horn symbol on your steering wheel (see illustration). The horn will operate only when this area is pressed.

### **NOTICE**

**Do not strike the horn severely to operate it, or hit it with your fist. Do not press on the horn with a sharp-pointed object.**

## MIRRORS

### Inside rearview mirror

Before you start driving, adjust the rearview mirror to the center on the view through the rear window.



#### WARNING

**Make sure your line of sight is not obstructed. Do not place objects in the rear seat, cargo area, or behind the rear headrests which could interfere with your vision through the rear window.**



#### WARNING

**To prevent serious injury during an accident or deployment of the airbag, do not modify the rearview mirror and do not install a wide mirror.**



#### WARNING

**NEVER adjust the mirror while driving. This may cause loss of vehicle control resulting in an accident.**

### Day/night rearview mirror



OBC3050054

[A] : Day, [B] :Night

Make this adjustment before you start driving and while the day/night lever is in the day position.

Pull the day/night lever toward you to reduce glare from the headlights of the vehicles behind you during night driving.

*Remember that you lose some rearview clarity in the night position.*



## Outside rearview mirror

Your vehicle is equipped with both left-hand and right-hand outside rearview mirrors.

### WARNING

#### Rearview mirrors

- Both right and left outside rear view mirror are convex. Objects seen in the mirror are closer than they appear.
- Use your interior rearview mirror or turn your head and look to determine the actual distance of following vehicles when changing lanes.

### WARNING

Do not adjust or fold the outside rearview mirrors while the vehicle is moving. This could result in loss of control, and an accident which could cause death, serious injury or property damage.

### NOTICE

- Do not scrape ice off the mirror face; this may damage the surface of the glass.
- If the mirror is jammed with ice, do not adjust the mirror by force. Use an approved de-icer (not radiator antifreeze) spray, a sponge or soft cloth with very warm water, or move the vehicle to a warm place and allow the ice to melt.

## Adjustion the rearview mirror



### Manual type (if equipped)

To adjust an outside mirror, move the control lever.



### Electric type (if equipped)

Move the lever (1) to the L (Left) or R (Right) to select the rearview mirror you would like to adjust.

Use the mirror adjustment control to position the selected mirror up, down, left or right.

### NOTICE

- The mirrors stop moving when they reach the maximum adjusting angles, but the motor continues to operate while the switch is pressed. Do not press the switch longer than necessary, the motor may be damaged.
- Do not attempt to adjust the outside rearview mirror by hand or the motor may be damaged.

### Folding the outside rearview mirror

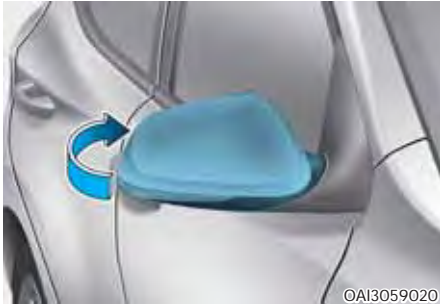

#### Manual type (if equipped)

To fold the outside rearview mirror, grasp the housing of the mirror and then fold it toward the rear of the vehicle.



#### Electric type (if equipped)

To fold the outside rearview mirror, press the button.

To unfold outside rearview mirror, press the button again.

If the button is pressed, the mirror will fold or unfold automatically.

### NOTICE

The electric type outside rearview mirror operates even though the ignition switch is in the ACC position. However, to prevent unnecessary battery discharge, do not adjust the mirrors longer than necessary while the engine is not running.

### NOTICE

Do not fold the electric type outside rearview mirror by hand. It could cause motor failure.

## WINDOWS

### Power windows (if equipped)

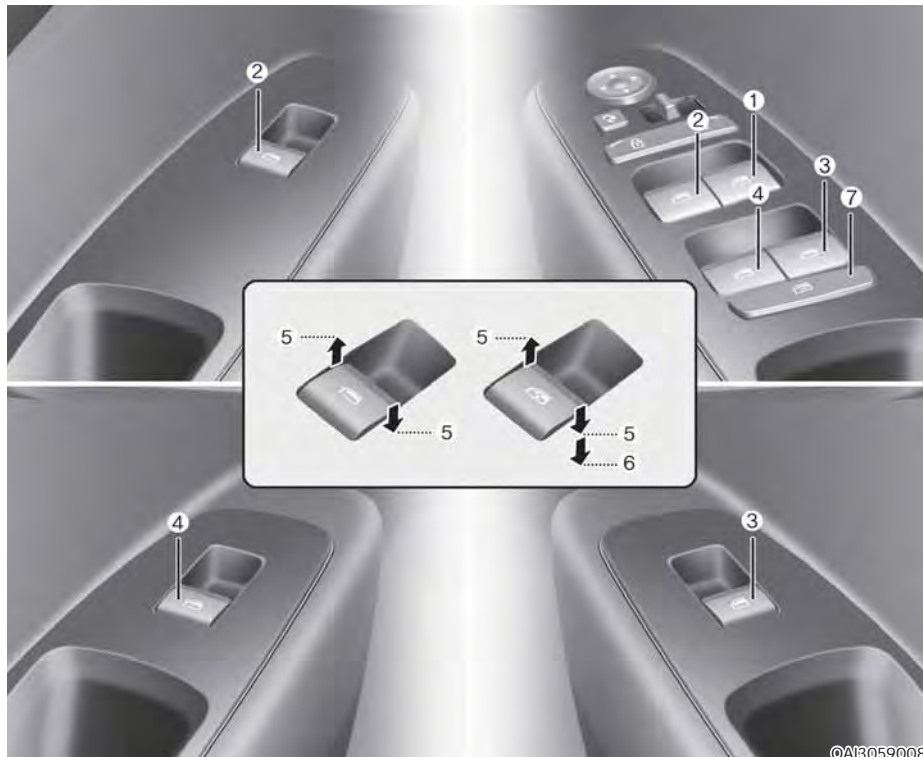

©A13059008

- (1) Driver's door power window switch\*
- (2) Front passenger's door window switch
- (3) Rear door window switch (Right)
- (4) Rear door window switch (Left)
- (5) Window opening and closing
- (6) Automatic power window\*
- (7) Power window lock switch\*

\* : if equipped

The ignition switch must be in the ON position to be able to raise or lower the windows. Each door has a Power Window switch to control that door's window. The driver has a Power Window Lock switch which can block the operation of rear passenger windows. The power windows will operate for approximately 30 seconds after the ignition switch is placed in the ACC or OFF position. However, if the front doors are opened, the Power Windows cannot be operated even within the 30 seconds period.



### WARNING

To avoid serious injury or death, do not extend your head, arms or body outside the windows while driving.



### Information

- In cold and wet climates, power windows may not work properly due to freezing conditions.
- While driving with the rear windows down or with the sunroof (if equipped) opened (or partially opened), your vehicle may demonstrate a wind buffeting or pulsation noise. This noise is normal and can be reduced or eliminated by taking the following actions. If the noise occurs with one or both of the rear windows down, partially lower both front windows approximately 2.5 cm (one inch).

### Window opening and closing



To open or close a window, press down or pull up the front portion of the corresponding switch to the first detent position (5).

### Auto down Window (if equipped) (Driver's window)



Pressing the power window switch momentarily to the second detent position (6) completely lowers the driver's window even when the switch is released. To stop the window at the desired position while the window is in operation, pull up and release the switch to the opposite direction of the window movement.

### *To reset the power windows*

If the power windows do not operate normally, the automatic power window system must be reset as follows:

1. Place the ignition switch to the ON position.
2. Close the window and continue pulling up on the power window switch for at least one second.

If the power windows do not operate properly after resetting, it is recommended that the system be checked by an authorized HYUNDAI dealer.



### **WARNING**

**The automatic reverse feature doesn't activate while resetting power window system. Make sure body parts or other objects are safely out of the way before closing the windows to avoid injuries or vehicle damage.**

### *Power window lock switch (if equipped)*



The driver can disable the power window switches on the rear passengers' doors by pressing the power window lock switch.

When the power window lock switch is pressed:

- The driver's master control can operate all the power windows.
- The front passenger's control can operate the front passenger's power window.
- The rear passenger's control cannot operate the rear passengers' power window.

### NOTICE

- To prevent possible damage to the power window system, do not open or close two windows or more at the same time. This will also ensure the longevity of the fuse.
- Never try to operate the main switch on the driver's door and the individual door window switch in opposite directions at the same time. If this is done, the window will stop and cannot be opened or closed.

### WARNING

- NEVER leave the keys in your vehicle with unsupervised children, when the engine is running.
- NEVER leave any child unattended in the vehicle. Even very young children may inadvertently cause the vehicle to move, entangle themselves in the windows, or otherwise injure themselves or others.
- Always double check to make sure arms, hands, head and other obstructions are safely out of the way before closing a window.
- Do not allow children to play with the power windows. Keep the driver's door power window lock switch in the LOCK position (pressed). Serious injury can result from unintentional window operation by the child.
- Do not extend your head, arms or body outside the windows while driving.

### Manual windows (if equipped)



To raise or lower the window, turn the window regulator handle clockwise or counterclockwise in the right side. And the left side is opposite direction.

### WARNING

When opening or closing the windows, make sure your passenger's arms, hands and body are safely out of the way.

## EXTERIOR FEATURES

### Hood

#### *Opening the hood*



1. Make sure the shift lever is in N (Neutral, for Automated manual transmission) or first gear or R (Reverse, for Manual transmission) and set the parking brake.
2. Pull the release lever to unlatch the hood. The hood should pop open slightly.



3. Go to the front of the vehicle, raise the hood slightly, push the secondary hood release lever up (1) inside of the hood center and lift the hood (2).



4. Pull out the support rod.
5. Hold the hood opened with the support rod.

#### **WARNING**

The support rod must be inserted completely into the hole provided whenever you inspect the engine compartment. This will prevent the hood from falling and possibly injuring you.

### *Closing the hood*

1. Before closing the hood, check the following:
  - All filler caps in the engine compartment must be correctly installed.
  - Gloves, rags or any other combustible materials must be removed from the engine compartment.
2. Return the support rod to its clip to prevent it from rattling.
3. Lower the hood halfway (lifted approximately 30 cm from the closed position) and push down to securely lock in place. Then double check to be sure the hood is secure.



### **WARNING**

**Always double check to be sure that the hood is firmly latched before driving away. Check there is no hood open warning light or message displayed on the instrument cluster. Driving with the hood opened may cause a total loss of visibility, which might result in an accident.**



### **WARNING**

- **Before closing the hood, ensure that all obstructions are removed from the hood opening. Closing the hood with an obstruction present in the hood opening may result in property damage or severe personal injury.**
- **Do not leave gloves, rags or any other combustible materials in the engine compartment. Doing so may cause a heat-induced fire.**
- **Do not move the vehicle with the hood raised. The view will be blocked and the hood could fall or be damaged.**

### **Tailgate**

#### *Opening the tailgate*



- The tailgate is locked or unlocked when all doors are locked or unlocked with the key, remote key, smart key or central door lock/unlock switch.
- If unlocked, the tailgate can be opened by pressing the handle and pulling it up.



### **Information**

**In cold and wet climates, door lock and door mechanisms may not work properly due to freezing conditions.**



 **WARNING**

The tailgate swings upward. Make sure no objects or people are near the rear of the vehicle when opening the tailgate.

**NOTICE**

Make certain that you close the tailgate before driving your vehicle. Possible damage may occur to the tailgate lift cylinders and attaching hardware if the tailgate is not closed prior to driving.

*Closing the tailgate*

To close the tailgate, lower and push down the tailgate firmly. Make sure that the tailgate is securely latched.

 **WARNING**

Always keep the tailgate lid completely closed while the vehicle is in motion. If it is left open or ajar, poisonous exhaust gases containing carbon monoxide (CO) may enter the vehicle and serious illness or death may result.

 **WARNING**

Rear cargo area

Occupants should never ride in the rear cargo area where no restraints are available. To avoid injury in the event of an accident or sudden stops, occupants should always be properly restrained.

 **WARNING**



Do not hold the part (gas lifter) that supports the tailgate. Be aware that the deformation of the part may cause vehicle damage and a risk of safety accident.

## Trunk

### Opening the trunk



Make sure the shift lever is in first gear or R (Reverse) and set the parking brake. Then do one of the following:

1. Unlock all doors with the Door Unlock button on your remote key or smart key. Pull the trunk release switch and open the trunk.
2. Press and hold the trunk Unlock button on the remote key or smart key.

### Closing the trunk

Lower the trunk lid and press down until it locks. To be sure the trunk lid is securely fastened, always check by trying to pull it up again.



## WARNING

**Always keep the trunk lid completely closed while the vehicle is in motion. If it is left open or ajar, poisonous exhaust gases containing carbon monoxide (CO) may enter the vehicle and serious illness or death may result.**



## Information

To prevent damage to the trunk lift cylinders and the attached hardware, always close the trunk before driving.

## NOTICE

In cold and wet climates, trunk lock and trunk mechanisms may not work properly due to freezing conditions.



## WARNING

- **NEVER** allow anyone to occupy the trunk of the vehicle at any time. If the trunk is partially or totally latched and the person is unable to get out, serious injury or death could occur due to lack of ventilation, exhaust fumes and rapid heat build-up, or because of exposure to cold weather conditions. The trunk is also a highly dangerous location in the event of a crash because it is not a protected occupant space but is a part of the vehicle's crush zone.
- Your vehicle should be kept locked and keys should be kept out of the reach of children. Parents should teach their children about the dangers of playing in trunks.

## Fuel filler door

### Opening the fuel filler door



The fuel filler door must be opened from inside the vehicle by pulling up the fuel filler door opener.

1. Stop the engine.
2. Pull the fuel filler door opener up.



3. Pull the fuel filler door out (1) to fully open.
4. To remove the fuel tank cap (2), turn it counterclockwise. You may hear a hissing noise as the pressure inside the tank equalizes.
5. Place the cap on the fuel filler door (3).

## **i** Information

If the fuel filler door does not open because ice has formed around it, tap lightly or push on the door to break the ice and release the door. Do not pry on the door. If necessary, spray around the door with an approved de-icer fluid (do not use radiator anti-freeze) or move the vehicle to a warm place and allow the ice to melt.

### Closing the fuel filler door

1. To install the fuel tank cap (2), turn it clockwise until it “clicks” once. This indicates that the cap is securely tightened.
2. Close the fuel filler door (1) and push it lightly and make sure that it is securely closed.

## **!** WARNING

Gasoline is highly flammable and explosive. Failure to follow these guidelines may result in **SERIOUS INJURY** or **DEATH**:

- Read and follow all warnings posted at the gas station.
- Before refueling, note the location of the Emergency Gasoline Shut-Off, if available, at the gas station.
- Before touching the fuel nozzle, you should eliminate the potential build-up of static electricity by touching a metal part of the vehicle, a safe distance away from the fuel filler neck, nozzle, or other gas source, with your bare hand.
- Do not use cellular phones while refueling. Electric current and/or electronic interference from cellular phones can potentially ignite fuel vapors and cause a fire.

- Do not get back into a vehicle once you have begun refueling. You can generate a buildup of static electricity by touching, rubbing or sliding against any item or fabric capable of producing static electricity. Static electricity discharge can ignite fuel vapors causing a fire. If you must re-enter the vehicle, you should once again eliminate potentially dangerous static electricity discharge by touching a metal part of the vehicle, away from the fuel filler neck, nozzle or other gasoline source, with your bare hand.
- When using an approved portable fuel container, be sure to place the container on the ground prior to refueling. Static electricity discharge from the container can ignite fuel vapors causing a fire. Once refueling has begun, contact between your bare hand and the vehicle should be maintained until the filling is complete.
- Use only approved portable plastic fuel containers designed to carry and store gasoline.
- When refueling, always move the shift lever to the N (Neutral) position (for Automated manual transmission) or first gear or R (Reverse, for manual transmission), set the parking brake, and place the ignition switch to the LOCK/OFF position. Sparks produced by electrical components related to the engine can ignite fuel vapors causing a fire.
- Do not use matches or a lighter and do not smoke or leave a lit cigarette in your vehicle while at a gas station, especially during refueling.
- Do not over-fill or top-off your vehicle tank, which can cause gasoline spillage.
- If a fire breaks out during refueling, leave the vicinity of the vehicle, and immediately contact the manager of the gas station and then contact the local fire department. Follow any safety instructions they provide.
- If pressurized fuel sprays out, it can cover your clothes or skin and thus subject you to the risk of fire and burns. Always remove the fuel cap carefully and slowly. If the cap is venting fuel or if you hear a hissing sound, wait until the condition stops before completely removing the cap.
- Always check that the fuel cap is installed securely to prevent fuel spillage in the event of an accident.

**i** Information

- Make sure to refuel your vehicle according to the “Fuel Requirements” suggested in the chapter 1.
- Do not spill fuel on the exterior surfaces of the vehicle. Any type of fuel spilled on painted surfaces may damage the paint.

**NOTICE**

If the fuel filler cap requires replacement, use only a genuine HYUNDAI cap or the equivalent specified for your vehicle. An incorrect fuel filler cap can result in a serious malfunction of the fuel system or emission control system.

## LIGHTING

### Exterior lights

#### Lighting control



OAI3052071

To operate the lights, turn the knob at the end of the control lever to one of the following positions:

- (1) OFF
- (2) Parking Light
- (3) Headlight
- (4) AUTO Light (if equipped)



OAI3052072

#### Headlight ( ㊦ )

When the light switch is in the head light position, the headlights, license plate light and instrument panel lights are turned ON.

#### **i** Information

**The ignition switch must be in the ON position to turn on the headlights.**



OAI3052073

#### Parking light ( ㊦ )

When the light switch is in the Parking (Position) light position, the Parking (Position) light, license plate light and instrument panel lights are turned ON.



OAI3052074

### AUTO light (if equipped)

When the light switch is in the AUTO position, the parking (position) light and headlights will be turned ON or OFF automatically depending on the amount of light outside the vehicle.

Even with the AUTO light feature in operation, it is recommended to manually turn ON the lights when driving at night or in a fog, or when you enter dark areas, such as tunnels and parking facilities.

### NOTICE

- Do not cover or spill anything on the sensor located on the instrument panel.
- Do not clean the sensor using a window cleaner, the cleanser may leave a light film which could interfere with sensor operation.
- If your vehicle window tint or other types of metallic coating on the front windshield, the AUTO light system may not work properly.

### High beam operation



OAI3052075

To turn on the high beam headlight, push the lever away from you. The lever will return to its original position.

The high beam indicator will light when the headlight high beams are switched on.

To turn off the high beam headlight, pull the lever towards you. The low beams will turn on.

### WARNING

Do not use high beam when there are other vehicles approaching you. Using high beam could obstruct the other driver's vision.



To flash the high beam headlights, pull the lever towards you, then release the lever. The high beams will remain ON as long as you hold the lever towards you.

### Turn signals and lane change signals



To signal a turn, push down on the lever for a right turn or up for a left turn in position (A). To signal a lane change, move the turn signal lever slightly and hold it in position (B). The lever will return to the OFF position when released or when the turn is completed.

If an indicator stays on and does not flash or if it flashes abnormally, one of the turn signal bulbs may be burned out and will require replacement.

#### **NOTICE**

**If the turn signal indicator stays on and does not flash, or if it flashes abnormally, a bulb may be burned out or have a poor electrical connection in the circuit. The bulb may require replacement.**



### One-touch turn signal function (if equipped)

To activate a one-touch turn signal function, move the turn signal lever slightly and then release it. The lane change signals will blink 3 times.

#### NOTICE

**If an indicator flash is abnormally quick or slow, a bulb may be burned out or have a poor electrical connection in the circuit.**

### Battery saver function (if equipped)

The purpose of this feature is to prevent the battery from being discharged. The system automatically turns off the position lamp when the driver turns the engine off and opens the driver-side door.

With this feature, the position lamps will turn off automatically if the driver parks on the side of road at night.

However, the position lamps stay ON even when the driver-side door is opened if the headlamp switch is turned to the position lamp or AUTO (if equipped) position after the engine is turned off.

If necessary, to keep the lamps on turn the position lamps OFF and ON again using the headlamp switch on the steering column after the engine is turned off.

#### NOTICE

**If the driver exits the vehicle through another door besides the driver door, the battery saver function does not operate and the headlight delay function does not turn OFF automatically.**

**This may cause the battery to discharge. To avoid battery discharge, turn OFF the headlights manually from the headlight switch before exiting the vehicle.**

### Headlight escort function (if equipped)

If you turn the ignition switch to the ACC or LOCK position with the headlights (Low) ON, the headlights remain on for about 5 minutes. However, if the driver's door is opened and closed, the headlights are turned off after 15 seconds.

The headlights can be turned off by pressing the lock button on the transmitter twice or turning the light switch to the OFF position.

For deactivation or activation of this feature, we recommend that you contact an authorized HYUNDAI dealer.

### Headlight leveling device (if equipped)



To adjust the headlight beam level according to the number of the passengers and loading weight in the luggage area, turn the beam leveling switch.

The higher the number of the switch position, the lower the headlight beam level. Always keep the headlight beam at the proper leveling position, or headlights may dazzle other road users.

Listed below are the examples of proper switch settings. For loading conditions other than those listed below, adjust the switch position so that the beam level may be the nearest as the condition obtained according to the list.

Loading condition	Switch position
Driver only	0
Driver + Front passenger	0
Full passengers (including driver)	1
Full passengers (including driver) + Maximum permissible loading	2
Driver + Maximum permissible loading	3

### ***Daytime running light (DRL) (if equipped)***

The Daytime Running Lights (DRL) can make it easier for others to see the front of your vehicle during the day, especially after dawn and before sunset.

The DRL system will turn the dedicated lamp OFF when:

1. The headlights or front fog lights are in the ON position.
2. The engine is turned off.

### Interior lights



#### **WARNING**

**Do not use the interior lights when driving in the dark. The interior lights may obscure your view and cause an accident.**

#### **NOTICE**

**Do not use the interior lights for extended periods when the engine is turned off or the battery will discharge.**

### Room lamp



- (1) : In the OFF position, the light stays off at all times even when a door is opened.
- (2): In the DOOR position, the light comes on when any door is opened regardless of the ignition switch position.

When doors are unlocked by the transmitter, the light comes on for approximately 30 seconds as long as any door is not opened. The light goes out gradually after approximately 30 seconds if the door is closed. However, if the ignition switch is ON or all doors are locked, the light will go out immediately.

If a door is opened with the ignition switch in the ACC or LOCK position, the light stays on for about 20 minutes.

However, if a door is opened with the ignition switch in the ON position, the light stays on continuously.

- (3) : In the ON position, the light stays on at all times.

### NOTICE

**Do not leave the lamp switches on for an extended period of time when the engine is turned off.**

### Luggage compartment lamp (if equipped)

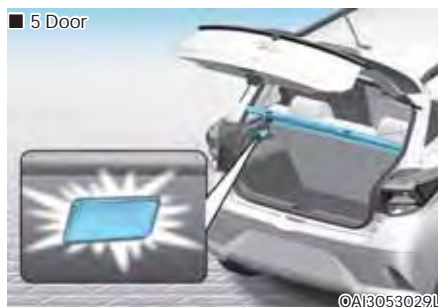

The luggage compartment lamp comes on when the tailgate is opened.

### NOTICE

**The luggage compartment lamp comes on as long as the tailgate/trunk lid is open. To prevent unnecessary charging system drain, close the tailgate/trunk lid securely after using the tailgate/trunk.**

*Mood lamp (if equipped)*



The lamp turns on when 'Ambient Light' is selected from the cluster User settings menu.

## WIPERS AND WASHERS

### ■ Front

- Type A



- Type B



OAI3059064/OAI3059065

### A : Wiper speed control

- MIST – Single wipe
- OFF – Off
- INT – Intermittent wipe\*
- LO – Low wiper speed
- HI – High wiper speed

### B : Wash with brief wipes (front)

\* : if equipped

### ■ Rear



OAI3059066

### C : Rear wiper/washer control (if equipped)

-  Wash with brief wipes
- ON – Continuous wipe
- OFF – Off

## Windshield wipers

Operates as follows when the ignition switch is turned ON.

**MIST** : For a single wiping cycle, move the lever upward (or downward) and release it. The wipers will operate continuously if the lever is held in this position.

**OFF** : The wiper is not in operation

**INT** : The wiper operates intermittently at the same wiping intervals. Use this mode in light rain or mist. To vary the speed setting, turn the speed control knob. (if equipped)

**LO** : The wiper runs at a lower speed.

**HI** : The wiper runs at a higher speed.

### Information

**If there is heavy accumulation of snow or ice on the windshield, defrost the windshield for about 10 minutes, or until the snow and/or ice is removed before using the windshield wipers, to ensure proper operation.**

**If you do not remove the snow and/or ice before using the wiper and washer, it may damage the wiper and washer system.**

## Windshield washers



In the OFF position, pull the lever gently toward you to spray washer fluid on the windshield and to run the wipers 1-3 cycles. The spray and wiper operation will continue until you release the lever.

If the washer does not work, you may need to add washer fluid to the washer fluid reservoir.

### WARNING

**When the outside temperature is below freezing, ALWAYS warm the windshield using the defroster to prevent the washer fluid from freezing on the windshield and obscuring your vision which could result in an accident and serious injury or death.**



## CAUTION

- To prevent possible damage to the washer pump, do not operate the washer when the fluid reservoir is empty.
- To prevent possible damage to the wipers or windshield, do not operate the wipers when the windshield is dry.
- To prevent damage to the wiper arms and other components, do not attempt to move the wipers manually.
- To prevent possible damage to the wipers and washer system, use anti-freezing washer fluids in the winter season or cold weather.

## Rear window wiper and washer switch (if equipped)



The rear window wiper and washer switches are located at the end of the wiper and washer switch lever.

Turn the switch to the desired position to operate the rear wiper and washer.

 – Wash with brief wipes

ON – Continuous wipe

OFF – Off

## MANUAL CLIMATE CONTROL SYSTEM (IF EQUIPPED)





OAI3059100

- (1) Temperature control knob
- (2) Fan speed control knob
- (3) Mode selection knob
- (4) Air intake control button  
(recirculated air position or outside (fresh) air position)
- (5) A/C (Air conditioning) button
- (6) Rear window defroster button (if equipped)



## Heating and air conditioning

1. Start the engine.
2. Set the mode to the desired position.
  - To improve the effectiveness of heating and cooling :
    - Heating: 
    - Cooling: 
3. Set the temperature control to the desired position.
4. Set the air intake control to the outside (fresh) air or recirculated air position.
5. Set the fan speed control to the desired speed.
6. If the air conditioning is desired, turn the system (if equipped) on.

### Mode selection





The mode selection knob controls the direction of the air flow through the ventilation system.

Air can be directed to the floor, dashboard outlets, or windshield. Five symbols are used to represent Face, Bi-Level, Floor, Floor-Defrost and Defrost air position.



**Face-Level (B, D, E)**

Air flow is directed toward the upper body and face. Additionally, each outlet can be controlled to direct the air discharged from the outlet.



**Bi-Level (B, C, D, E)**

Air flow is directed towards the face and the floor.



**Floor-Level (A, C, D)**

Most of the air flow is directed to the floor, with a small amount of the air being directed to the windshield, side window defrosters and side vents.



**Floor/Defrost-Level (A, C, D)**

Most of the air flow is directed to the floor and the windshield with a small amount directed to the side window defrosters and side vents.



**Defrost-Level (A, D)**

Most of the air flow is directed to the windshield with a small amount of air directed to the side vents.

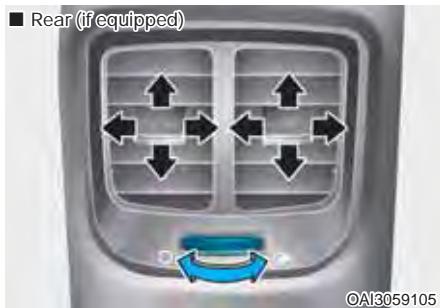

### Instrument panel vents

You can adjust the direction of air delivered from these vents using the vent control lever as shown.

The outlet vents located in the rear can be opened or closed separately using the thumbwheel.

### Temperature control



The temperature will increase by turning the knob to the right.

The temperature will decrease by turning the knob to the left.

### Air intake control



This button is used to select the outside (fresh) air position or recirculated air position.

### Recirculation mode



The indicator light on the button illuminates when the recirculated air position is selected. With the recirculated air position selected, air from the passenger compartment will be drawn through the climate control system and heated or cooled according to the function selected.

### Fresh mode



The indicator light on the button will turn off when the outside (fresh) air position is selected. With the outside (fresh) air position selected, air enters the vehicle from outside and is heated or cooled according to the function selected.



### WARNING

- Continued use of the climate control system operation in the recirculated air position can cause drowsiness or sleepiness, that may cause loss of vehicle control resulting in an accident. Set the air intake control to the outside (fresh) air position as much as possible while driving.
- Continued use of the climate control system operation in the recirculated air position (without the air conditioning selected) may allow humidity to increase inside the vehicle which may fog the glass and obscure visibility.
- Do not sleep in a vehicle with the air conditioning or heating system on. It may cause serious harm or death due to a drop in the oxygen level and/or body temperature.



### Information

**Prolonged use of the air conditioning with the recirculated air position selected will result in excessive dry air in the passenger compartment.**

### Fan speed control



Turn the knob to the right to increase the fan speed and airflow. Turn the knob to the left to decrease fan speed and airflow.

### Air conditioning (A/C) (if equipped)



Press the A/C button to turn the air conditioning system on (indicator light will illuminate). Press the button again to turn the air conditioning system off.

## System operation

### Ventilation

1. Select the Face Level  mode.
2. Set the air intake control to fresh mode.
3. Set the temperature control to the desired position.
4. Set the fan speed control to the desired speed.

### Heating

1. Select the Floor Level  mode.
2. Set the air intake control to fresh mode.
3. Set the temperature control to the desired position.
4. Set the fan speed control to the desired speed.
5. If desired, turn the air conditioning ON with the temperature control knob set to heat in order to dehumidify the air before it enters into the cabin.

If the windshield fogs up, select the Floor & Defrost  mode or press the Front Defrost  mode.

### Operation Tips

- To keep dust or unpleasant fumes from entering the vehicle through the ventilation system, temporarily set the air intake control to the recirculation mode. Be sure to return the control to fresh mode position when the irritation has passed to keep fresh air in the vehicle. This will help keep the driver alert and comfortable.
- To prevent interior fog on the windshield, set the air intake control to fresh mode and fan speed to the desired position, turn on the air conditioning system, and adjust the temperature control to desired temperature.

### *Air conditioning (if equipped)*

HYUNDAI Air Conditioning Systems are filled with R-134a refrigerant.

1. Start the engine.
2. Push the air conditioning button.
3. Select the Face Level  mode.
4. Set the air intake control to the Recirculation mode temporarily to allow the cabin to cool quickly. When the desired temperature in the cabin is reached, change the air intake control back to Fresh mode.
5. Adjust the fan speed control and temperature control to maintain maximum comfort.

### **NOTICE**

- **The refrigerant system should only be serviced by trained and certified technicians to insure proper and safe operation.**
- **The refrigerant system should be serviced in a well-ventilated place.**

### **Information**

- **When using the air conditioning system, monitor the temperature gauge closely while driving up hills or in heavy traffic when outside temperatures are high. Air conditioning system operation may cause engine overheating. Continue to use the blower fan but turn the air conditioning system off if the temperature gauge indicates engine overheating.**
- **When opening the windows in humid weather, air conditioning may create water droplets inside the vehicle. Since excessive water droplets may cause damage to electrical equipment, air conditioning should only be used with the windows closed.**

### Air conditioning system operation tips

- If the vehicle has been parked in direct sunlight during hot weather, open the windows for a short time to let the hot air inside the vehicle escape.
- After sufficient cooling has been achieved, switch back from recirculation mode to fresh mode.
- To help reduce moisture inside of the windows on rainy or humid days, decrease the humidity inside the vehicle by operating the air conditioning system with the windows and sunroof closed.
- During the air conditioning system operation, you may occasionally notice a slight change in engine speed as the air conditioning compressor cycles. This is a normal system operation characteristic.
- Use the air conditioning system every month only for a few minutes to ensure maximum system performance.
- When using the air conditioning system, you may notice clear water dripping (or even puddling) on the ground under the passenger side of the vehicle. This is a normal system operation characteristic.
- If you operate the air conditioner excessively, the difference between the temperature of the outside air and that of the windshield could cause the outer surface of the windshield to fog up, causing loss of visibility. In this case, set the mode selection button to the  position and set the fan speed control knob to the lowest speed setting.

### System maintenance

#### Climate control air filter

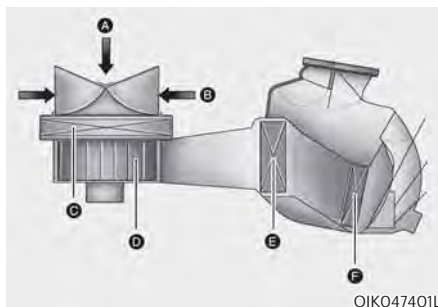

[A] : Outside air, [B] : Recirculated air  
[C] : Climate control air filter, [D] : Blower  
[E] : Evaporator core, [F] : Heater core

This filter is installed behind the glove box. It filters the dust or other pollutants that enter the vehicle through the heating and air conditioning system.

We recommend that the climate control air filter be replaced by an authorized HYUNDAI dealer according to the maintenance schedule. If the vehicle is being driven in severe conditions such as dusty or rough roads, more frequent climate control filter inspections and changes are required.

If the air flow rate suddenly decreases, we recommend the system be checked at an authorized HYUNDAI dealer.

#### Information

- **Replace the filter according to the Maintenance Schedule.**
- **If the car is being driven in severe conditions such as dusty, rough roads, more frequent climate control air filter inspections and changes are required.**
- **When the air flow rate suddenly decreases, we recommend that the system be checked by an authorized HYUNDAI dealer.**

### *Checking the amount of air conditioner refrigerant and compressor lubricant*

When the amount of refrigerant is low, the performance of the air conditioning is reduced. Overfilling also has a bad influence on the air conditioning system.

Therefore, if abnormal operation is found, we recommend that the system be inspected by an authorized HYUNDAI dealer.

#### **NOTICE**

**It is important that the correct type and amount of oil and refrigerant is used. Otherwise, damage to the compressor and abnormal system operation may occur. To prevent damage, the air conditioning system in your vehicle should only be serviced by trained and certified technicians.**



#### **WARNING**

Vehicles equipped with R-134a



Since the refrigerant is operated at very high pressure, the air conditioning system should only be serviced by trained and certified technicians.

All refrigerants should be reclaimed with proper equipment.

Venting refrigerants directly to the atmosphere is harmful to individuals and environment. Failure to heed these warnings can lead to serious injuries.



## AUTOMATIC CLIMATE CONTROL SYSTEM (IF EQUIPPED)



OAI30591011

1. Fan speed control knob
2. A/C (Air conditioning) button
3. Recirculation mode/Fresh mode
4. Mode selection button
5. Rear window defroster button (if equipped)
6. Front windshield defroster button
7. OFF button
8. Temperature control knob
9. AUTO (automatic control) button
10. Climate control screen

## Automatic heating and air conditioning

The Automatic Climate Control System is controlled by setting the desired temperature.



1. Press the AUTO button.

The modes, fan speeds, air intake and air-conditioning will be controlled automatically by the temperature setting you select.



2. Turn the temperature control knob to set the desired temperature. If the temperature is set to the lowest setting (Lo), the air conditioning system will operate continuously.

To turn the automatic operation off, select any button of the following:

- Mode selection button
- Front windshield defrost button (Press the button one more time to deselect the front windshield defroster function.)
- Fan speed control button

The selected function will be controlled manually while other functions operate automatically.

For your convenience and to improve the effectiveness of the climate control, use the AUTO button and set the temperature to 23°C (73°F).

### Information



**Never place anything near the sensor located to ensure better control of the heating and cooling system.**

## Manual heating and air conditioning

The heating and cooling system can be controlled manually by pressing buttons other than the AUTO button. In this case, the system works sequentially according to the order of buttons selected.

When pressing any button (or turning any knob) except the AUTO button while using automatic operation, the functions not selected will be controlled automatically.

1. Start the engine.
2. Set the mode to the desired position.  
To improve the effectiveness of heating and cooling:

- Heating: 

- Cooling: 

3. Set the temperature control to the desired position.
4. Press the fresh button.
5. Set the fan speed control to the desired speed.
6. If air conditioning is desired, turn the air conditioning system on.
7. Press the AUTO button in order to convert to full automatic control of the system.

### Mode selection



OAI3053103



The mode selection button controls the direction of the air flow through the ventilation system.



**Face-Level (B, D, E)**

Air flow is directed toward the upper body and face. Additionally, each outlet can be controlled to direct the air discharged from the outlet.



**Bi-Level (B, C, D, E)**

Air flow is directed towards the face and the floor.



**Floor-Level (A, C, D)**

Most of the air flow is directed to the floor, with a small amount of the air being directed to the windshield, side window defrosters and side vents.



**Floor/Defrost-Level (A, C, D)**

Most of the air flow is directed to the floor and the windshield with a small amount directed to the side window defrosters and side vents.



**Defrost-Level (A, D)**

Most of the air flow is directed to the windshield with a small amount of air directed to the side window defrosters.



### Instrument panel vents

You can adjust the direction of air delivered from these vents using the vent control lever as shown.

The outlet vents located in the rear can be opened or closed separately using the thumbwheel.

### Temperature control



The temperature will increase by turning the knob to the right.

The temperature will decrease by turning the knob to the left.

The temperature will increase or decrease by 0.5 °C (1 °F) for each time you turn the knob. When set to the lowest temperature setting, the air conditioning will operate continuously.

### Air intake control



The air intake control button is used to select either Fresh mode (outside air) or Recirculation mode (cabin air).

### Recirculated air position



The indicator light on the button illuminates when the recirculated air position is selected. With the recirculated air position selected, air from the passenger compartment will be drawn through the climate control system and heated or cooled according to the function selected.

### Outside (fresh) air position



The indicator light on the button will turn off when the outside (fresh) air position is selected. With the outside (fresh) air position selected, air enters the vehicle from outside and is heated or cooled according to the function selected.

### Information

Operating the system primarily in Fresh mode is recommended. Use Recirculation mode temporarily only when needed.

Prolonged operation of the heater in Recirculation mode and without the A/C ON can cause fogging of the windshield.

In addition, prolonged use of the A/C ON in Recirculation mode may result in excessively dry, dehumidified air in the cabin and may promote formation of musty vent odor due to stagnant air.

### WARNING

- Continued use of the climate control system operation in the recirculated air position can cause drowsiness or sleepiness, that may cause loss of vehicle control resulting in an accident. Set the air intake control to the outside (fresh) mode as much as possible while driving.
- Continued use of the climate control system operation in the recirculated air position (without the air conditioning selected) may allow humidity to increase inside the vehicle which may fog the glass and obscure visibility.
- Do not sleep in a vehicle with the air conditioning or heating system on. It may cause serious harm or death due to a drop in the oxygen level and/or body temperature.

### Fan speed control



Turn the knob to the right to increase the fan speed and air flow. Turn the knob to the left to decrease fan speed and air flow.

#### **NOTICE**

Operating the fan speed when the ignition switch is in the ON position could cause the battery to discharge. Operate the fan speed when the engine is running.

### Air conditioning



Push the A/C button to manually turn the system on (indicator light will illuminate) and off.

### OFF mode



Push the OFF button to turn off the climate control system. You can still operate the mode and air intake buttons with the ignition switch in the ON position.

### System operation

#### Ventilation

1. Select the Face Level  mode.
2. Set the air intake control to fresh mode.
3. Set the temperature control to the desired position.
4. Set the fan speed control to the desired speed.

#### Heating

1. Select the Floor Level  mode.
2. Set the air intake control to fresh mode.
3. Set the temperature control to the desired position.
4. Set the fan speed control to the desired speed.
5. If desired, turn the air conditioning ON with the temperature control knob set to heat in order to dehumidify the air before it enters into the cabin.

If the windshield fogs up, select the Front Defrost  mode.

#### Operation Tips

- To keep dust or unpleasant fumes from entering the vehicle through the ventilation system, temporarily set the air intake control to the recirculation mode. Be sure to return the control to fresh mode position when the irritation has passed to keep fresh air in the vehicle. This will help keep the driver alert and comfortable.
- To prevent interior fog on the windshield, set the air intake control to fresh mode and fan speed to the desired position, turn on the air conditioning system, and adjust the temperature control to desired temperature.

#### Air conditioning

HYUNDAI Air Conditioning Systems are filled with R-134a refrigerant.

1. Start the engine.
2. Push the air conditioning button.
3. Select the Face Level  mode.
4. Set the air intake control to the Recirculation mode temporarily to allow the cabin to cool quickly. When the desired temperature in the cabin is reached, change the air intake control back to Fresh mode.
5. Adjust the fan speed control and temperature control to maintain maximum comfort.



**NOTICE**

- **The refrigerant system should only be serviced by trained and certified technicians to insure proper and safe operation.**
- **The refrigerant system should be serviced in a well-ventilated place.**

**i Information**

- **When using the air conditioning system, monitor the temperature gauge closely while driving up hills or in heavy traffic when outside temperatures are high. Air conditioning system operation may cause engine overheating. Continue to use the blower fan but turn the air conditioning system off if the temperature gauge indicates engine overheating.**
- **When opening the windows in humid weather, air conditioning may create water droplets inside the vehicle. Since excessive water droplets may cause damage to electrical equipment, air conditioning should only be used with the windows closed.**

**Air conditioning system operation tips**

- If the vehicle has been parked in direct sunlight during hot weather, open the windows for a short time to let the hot air inside the vehicle escape.
- After sufficient cooling has been achieved, switch back from the recirculation mode to the fresh mode.
- To help reduce moisture inside of the windows on rainy or humid days, decrease the humidity inside the vehicle by operating the air conditioning system with the windows and sunroof closed.
- During the air conditioning system operation, you may occasionally notice a slight change in engine speed as the air conditioning compressor cycles. This is a normal system operation characteristic.
- Use the air conditioning system every month only for a few minutes to ensure maximum system performance.
- When using the air conditioning system, you may notice clear water dripping (or even puddling) on the ground under the passenger side of the vehicle. This is a normal system operation characteristic.
- If you operate the air conditioner excessively, the difference between the temperature of the outside air and that of the windshield could cause the outer surface of the windshield to fog up, causing loss of visibility. In this case, set the mode selection button to the  position and set the fan speed control knob to the lowest speed setting.

## System maintenance

### Climate control air filter

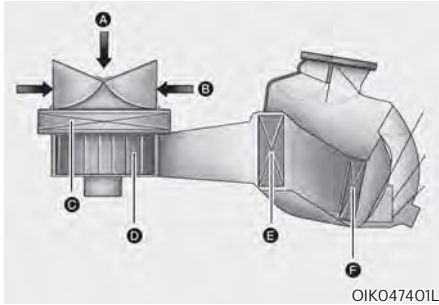

[A] : Outside air, [B] : Recirculated air  
 [C] : Climate control air filter, [D] : Blower  
 [E] : Evaporator core, [F] : Heater core

This filter is installed behind the glove box. It filters the dust or other pollutants that enter the vehicle through the heating and air conditioning system.

We recommend that the climate control air filter be replaced by an authorized HYUNDAI dealer according to the maintenance schedule. If the vehicle is being driven in severe conditions such as dusty or rough roads, more frequent climate control filter inspections and changes are required.

If the air flow rate suddenly decreases, we recommend the system be checked at an authorized HYUNDAI dealer.

### **i** Information

- **Replace the filter according to the Maintenance Schedule.**
- **If the car is being driven in severe conditions such as dusty, rough roads, more frequent climate control air filter inspections and changes are required.**
- **When the air flow rate suddenly decreases, we recommend that the system be checked by an authorized HYUNDAI dealer.**

### *Checking the amount of air conditioner refrigerant and compressor lubricant*

When the amount of refrigerant is low, the performance of the air conditioning is reduced. Overfilling also has a bad influence on the air conditioning system.

Therefore, if abnormal operation is found, we recommend that the system be inspected by an authorized HYUNDAI dealer.

### **NOTICE**

**It is important that the correct type and amount of oil and refrigerant is used. Otherwise, damage to the compressor and abnormal system operation may occur. To prevent damage, the air conditioning system in your vehicle should only be serviced by trained and certified technicians.**



### **WARNING**

**Vehicles equipped with R-134a**





**Since the refrigerant is operated at very high pressure, the air conditioning system should only be serviced by trained and certified technicians.**

**All refrigerants should be reclaimed with proper equipment.**

**Venting refrigerants directly to the atmosphere is harmful to individuals and environment. Failure to heed these warnings can lead to serious injuries.**

## WINDSHIELD DEFROSTING AND DEFOGGING

### WARNING

Do not use the  or  position during cooling operation in extremely humid weather. The difference between the temperature of the outside air and that of the windshield could cause the outer surface of the windshield to fog up, causing loss of visibility. Set the mode selection to the  position and fan speed control to a lower speed.

- For maximum defrosting, set the temperature control to the extreme right/hot position and the fan speed control to the highest speed.
- If warm air to the floor is desired while defrosting or defogging, set the mode to the floor-defrost position.
- Before driving, clear all snow and ice from the windshield, rear window, outside rear view mirrors, and all side windows.
- Clear all snow and ice from the hood and air inlet at the bottom of the windshield.





### Information

If the engine temperature is still cold after starting, then a brief engine warm up period may be required for the vented air flow to become warm or hot.

### Manual climate control system

#### *To defog inside windshield*



1. Select desired fan speed.
2. Select desired temperature.
3. Select the  or  position.
4. The outside (fresh) air will be selected automatically. Additionally, the air conditioning will automatically operate if the mode is selected to the  or  position.

If the air conditioning and outside (fresh) mode are not selected automatically, press the corresponding button manually.

*To defrost outside windshield*



1. Set the fan speed to the highest (extreme right) position.
2. Set the temperature to the extreme hot position.
3. Select the  position.
4. The outside (fresh) mode and air conditioning will be selected automatically.

**Automatic climate control system**

*To defog inside windshield*



1. Select desired blower speed.
2. Select desired temperature.
3. Press the defroster button ().
4. The air-conditioning will turn on according to the detected ambient temperature, fresh mode and higher blower speed will be selected automatically.

If the air-conditioning, the fresh mode and higher blower speed are not selected automatically, adjust the corresponding button or knob manually.

If the  position is selected, lower blower speed is controlled to higher blower speed.

### To defrost outside windshield



1. Set blower speed to the highest position.
2. Set temperature to the extreme hot (HI) position.
3. Press the defroster button (  ).
4. The air-conditioning will turn on according to the detected ambient temperature and fresh mode will be selected automatically.

If the  position is selected, lower blower speed is controlled to higher blower speed.

### Defroster

#### NOTICE

To prevent damage to the conductors bonded to the inside surface of the rear window, never use sharp instruments or window cleaners containing abrasives to clean the window.

#### Information

If you want to defrost and defog the front windshield, refer to “Windshield Defrosting and Defogging” in this chapter.

### Rear window defroster (if equipped)

■ Manual climate control system



■ Automatic climate control system

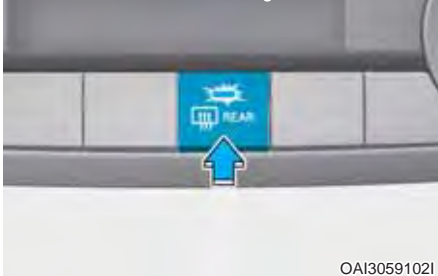

The defroster heats the window to remove frost, fog and thin ice from the interior and exterior of the rear window, while engine is running.

- To activate the rear window defroster, press the rear window defroster button located in the center facia switch panel. The indicator on the rear window defroster button illuminates when the defroster is ON.
- To turn off the defroster, press the rear window defroster button again.

### **i** Information

- If there is heavy accumulation of snow on the rear window, brush it off before operating the rear defroster.
- The rear window defroster automatically turns off after approximately 20 minutes or when the ignition switch is in the LOCK/OFF position.

## STORAGE COMPARTMENT

### WARNING

#### Flammable materials

Do not store cigarette lighters, propane cylinders, or other flammable/explosive materials in the vehicle. These items may catch fire and/or explode if the vehicle is exposed to hot temperatures for extended periods.

### WARNING

ALWAYS keep the storage compartment covers closed securely while driving. Items inside your vehicle are moving as fast as the vehicle. If you have to stop or turn quickly, or if there is a crash, the items may fly out of the compartment and may cause an injury if they strike the driver or a passenger.

### NOTICE

To avoid possible theft, do not leave valuables in the storage compartment.

### Center console storage (if equipped)



These compartments can be used to store small item.

## Glove box



To open the glove box, pull the lever and the glove box will automatically open. Close the glove box after use.

### **WARNING**

**ALWAYS** close the glove box door after use.

An open glove box door can cause serious injury to the passenger in an accident, even if the passenger is wearing a seat belt.

## Cool box (if equipped)



You can keep beverage cans or other items cool in the glove box.

1. Turn on the air conditioning.
2. Turn the open/close switch of the vent installed in the glove box to the open position.
3. When the cool box is not used, turn the switch to the closed position.

### **WARNING**

Do not put perishable food in the cool box because it may not maintain the necessary consistent temperature to keep the food fresh.

### **Information**

- If the vent is blocked by items in the coolbox, cooling will be reduced.
- If the climate control system's temperature control is in the warm or hot position, Cold air only will flow into the glove box.



## INTERIOR FEATURES

### Clock (if equipped)



#### WARNING

Do not adjust the clock while driving. You may lose your steering control and cause severe personal injury or accidents.

### Cup holder

#### Front



Cups or small beverage cans may be placed in the cup holders.

#### Rear (if equipped)



To use the center cup holder, pull down the armrest



#### WARNING

- Avoid abrupt starting and braking when the cup holder is in use to prevent spilling your drink. If hot liquid spills, you could be burned. Such a burn to the driver could cause loss of vehicle control resulting in an accident.
- Do not place uncovered or unsecured cups, bottles, cans, etc., in the cup holder containing hot liquid while the vehicle is in motion. Injuries may result in the event of sudden stop or collision.
- Only use soft cups in the cup holders. Hard objects can injure you in an accident.



#### WARNING

Keep cans or bottles out of direct sun light and do not put them in a hot vehicle. It may explode.

#### NOTICE

- Keep your drinks sealed while driving to prevent spilling your drink. If liquid spills, it may get into the vehicle's electrical/electronic system and damage electrical/electronic parts.
- When cleaning spilled liquids, do not dry the cup holder at high temperature. This may damage the cup holder.

## Sunvisor

■ Driver's side



■ Passenger's side

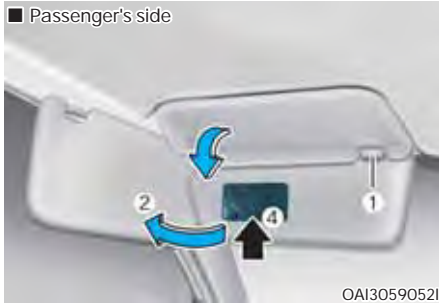

Use the sunvisor to shield direct light through the front or side windows.

To use a sunvisor for a side window, pull it downward, unsnap it from the bracket (1) and swing it to the side (2).

A mirror (4, if equipped) and ticket holder (3, if equipped) are provided on the sunvisor.

### **WARNING**

For your safety, do not block your view when using the sunvisor.

### **NOTICE**

Do not put several tickets in the ticket holder at one time. This could cause damage to the ticket holder.

## Power outlet (if equipped)

■ Front



■ Rear



The power outlet is designed to provide power for mobile telephones or other devices designed to operate with vehicle electrical systems. The devices should draw less than 120 W (Watt) with the engine running.

### **WARNING**

Avoid electrical shocks. Do not place your fingers or foreign objects (pin, etc.) into a power outlet or touch the power outlet with a wet hand.

**NOTICE**

To prevent damage to the Power outlet:

- Use the power outlet only when the engine is running and remove the accessory plug after use. Using the accessory plug for prolonged periods of time with the engine off could cause the battery to discharge.
- Only use 12 V electric accessories which are less than 120 W (Watt) in electric capacity.
- Adjust the air-conditioner or heater to the lowest operating level when using the power outlet.
- Close the cover when not in use.
- Some electronic devices can cause electronic interference when plugged into a vehicle's power outlet. These devices may cause excessive audio static and malfunctions in other electronic systems or devices used in your vehicle.
- Push the plug in as far as it will go. If good contact is not made, the plug may overheat or the internal temperature fuse may open.
- Plug in battery equipped electrical/electronic devices with the reverse current protection. The current from the battery may flow into the vehicle's electrical/electronic system and cause system malfunction.

**USB charger (if equipped)**

The USB charger is designed to recharge batteries of small size electrical devices using a USB cable.

The electrical devices can be recharged when the ignition switch is in the ACC, ON or START position.

The battery charging state may be monitored on the electrical device.

Disconnect the USB cable from the USB port after use.

- A smart phone or a tablet PC may get warmer during the re-charging process. It does not indicate any malfunction with the charging system.
- A smart phone or a tablet PC, which adopts a different re-charging method, may not be properly re-charged. In this case, use an exclusive charger of your device.
- The charging terminal is only to recharge a device. Do not use the charging terminal either to turn ON an audio or to play media on the infotainment system.

### Coat hook (if equipped)



These hooks are not designed to hold large or heavy items.

#### **WARNING**

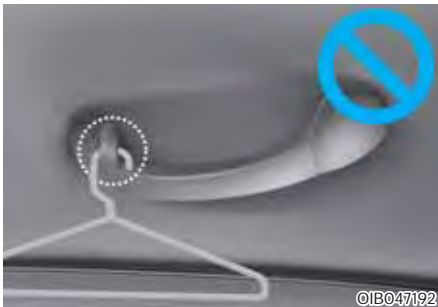

Do not hang other objects such as hangers or hard objects except clothes. Also, do not put heavy, sharp or breakable objects in the clothes pockets. In an accident or when the curtain airbag is inflated, it may cause vehicle damage or personal injury.

### Floor mat anchor(s) (if equipped)



ALWAYS use the Floor Mat Anchors to attach the front floor mats to the vehicle. The anchors on the front floor carpet keep the floor mats from sliding forward.

#### **WARNING**

The following must be observed when installing ANY floor mat to the vehicle.

- Ensure that the floor mats are securely attached to the vehicle's floor mat anchor(s) before driving the vehicle.
- Do not use ANY floor mat that cannot be firmly attached to the vehicle's floor mat anchors.
- Do not stack floor mats on top of one another (for example, all-weather rubber mat on top of a carpeted floor mat). Only a single floor mat should be installed in each position.

**IMPORTANT** - Your vehicle was manufactured with driver's side floor mat anchors that are designed to securely hold the floor mat in place. To avoid any interference with pedal operation, HYUNDAI recommends that the HYUNDAI floor mat designed for use in your vehicle be installed.

### Cargo area cover (5 Door, if equipped)



Use the cargo area cover to hide items stored in the cargo area.

The cargo area cover can be uprighted or removed.



### WARNING

- Do not place objects on the cargo area cover. Such objects may be thrown about inside the vehicle and possibly injure vehicle occupants during an accident or braking.
- Never allow anyone to ride in the luggage compartment. It is designed for luggage only.

### NOTICE

Do not put luggage on the cover since it may be damaged or malformed.

## EXTERIOR FEATURES

### Roof rack (if equipped)



Do not load cargo on the roof. The roof rack is not for loading cargo but for aesthetic purpose.

## INFOTAINMENT SYSTEM

### NOTICE

- If you install an aftermarket HID head lamp, your vehicle's audio and electronic device may malfunction.
- Prevent chemicals such as perfume, cosmetic oil, sun cream, hand cleaner, and air freshener from contacting the interior parts because they may cause damage, button struck issues or discoloration.

### USB port (if equipped)



You can use a USB port to plug in USB to play music.

**NOTE :** Please go through **USB compatibility list** in **HYUNDAI India website**.

### **i** Information

When using a portable audio device connected to the power outlet, noise may occur during playback. If this happens, use the power source of the portable audio device.

Depending on the car model above layout may be vary.

### Antenna



#### *Type A*

The roof antenna receives both AM and FM broadcast signals. Rotate the roof antenna in a counterclockwise direction to remove it. Rotate it in a clockwise direction to reinstall it.



#### *Type B*

The shark fin antenna receives transmitted data. (for example: AM/FM)

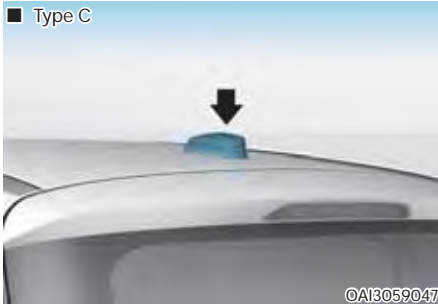

### Type C

This antenna is dummy for aesthetic purpose.

#### NOTICE

- Before entering a place with a low height clearance, be sure that the antenna is removed.
- Be sure to remove the antenna before washing the vehicle in an automatic car wash or it may be damaged.
- When reinstalling your antenna, it is important that it is fully tightened and adjusted to the upright position to ensure proper reception. But it could be removed when parking the vehicle.

#### NOTICE

Installation of aftermarket antenna may result in water leakage, wind noise, rattling & improper radio operation. We recommend to use the antenna available with an authorized Hyundai dealer.

### **i** Information

Some models do not have audio (plastic blanking cover) system, and will not supply radio main cable. Thus if you want to insert an aftermarket audio or OEM audio to listen radio broadcasting service, we recommend to use the feeder cable available with an authorized HYUNDAI dealer.

### Steering wheel audio control (if equipped)

#### ■ Type A



#### ■ Type B



#### ■ Type C



The steering wheel audio control switches are installed for your convenience.

#### NOTICE

**Do not operate audio remote control buttons simultaneously.**

### **VOLUME (VOL + / VOL -) (1)**

- Move the VOLUME toggle switch up to increase volume.
- Move the VOLUME toggle switch down to decrease volume.

### **SEEK/PRESET (^ / v) (2)**

If the SEEK/PRESET toggle switch is moved up or down and held for 0.8 seconds or more, it will function in the following modes.

#### **RADIO mode**

It will function as the AUTO SEEK select switch. It will SEEK until you release the switch.

#### **MEDIA mode**

It will function as the FF/REW switch (except in Bluetooth audio mode).

If the SEEK/PRESET toggle switch is moved up or down, it will function in the following modes.

#### **RADIO mode**

It will function as the PRESET STATION UP/DOWN switch.

#### **MEDIA mode**

It will function as the TRACK UP/ DOWN switch.

### **MODE (⊙) (3)**

Press the MODE button to select RADIO/MEDIA/Bluetooth Audio, etc.

### **MUTE (M) (4, if equipped)**

- Press the button to mute the sound.
- Press the button again to activate the sound.
- During a call, press to turn off the microphone.

## **Information**

**Detailed information for audio control buttons are described in the following pages in this chapter.**

### **Audio/Video (if equipped)**

Detailed information for the system is described in a separately supplied manual.



## Bluetooth® Wireless Technology hands-free (if equipped)



You can use the phone wirelessly by using the Bluetooth® Wireless Technology.

- (1) Call / Answer button
- (2) Call end button
- (3) Microphone

- Audio : For detailed information, refer to “AUDIO” in this chapter.
- Navigation : Detailed information for the Bluetooth® Wireless Technology hands-free is described in the manual supplied separately.

Depending on the car model above layout may be vary.

## How vehicle audio works

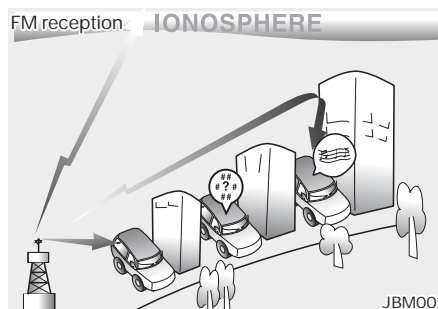

AM and FM radio signals are broadcast from transmitter towers located around your city. They are intercepted by the radio antenna on your vehicle. This signal is then processed by the radio and sent to your vehicle speakers.

When a strong radio signal has reached your vehicle, the precise engineering of your audio system ensures the best possible quality reproduction. However, in some cases the signal coming to your vehicle may not be strong and clear.

This can be due to factors, such as the distance from the radio station, closeness of other strong radio stations or the presence of buildings, bridges or other large obstructions in the area.

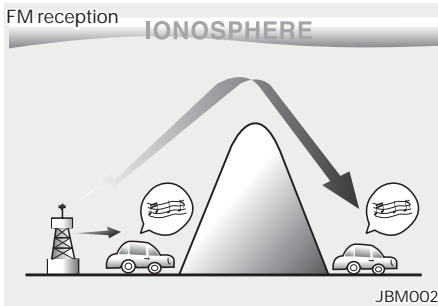

AM broadcasts can be received at greater distances than FM broadcasts. This is because AM radio waves are transmitted at low frequencies. These long distance, low frequency radio waves can follow the curvature of the earth rather than travelling straight. In addition, they curve around obstructions resulting in better signal coverage.

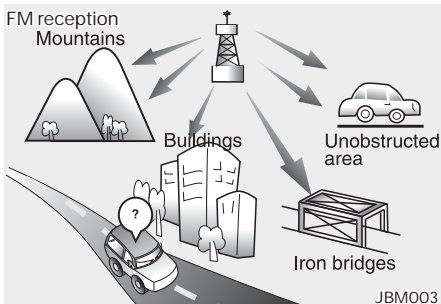

FM broadcasts are transmitted at high frequencies and do not bend to follow the earth's surface. Because of this, FM broadcasts generally begin to fade within short distances from the station. Also, FM signals are easily affected by buildings, mountains, and obstructions. This can lead to undesirable or unpleasant listening conditions which might lead you to believe a problem exists with your radio.

The following conditions are normal and do not indicate radio trouble:

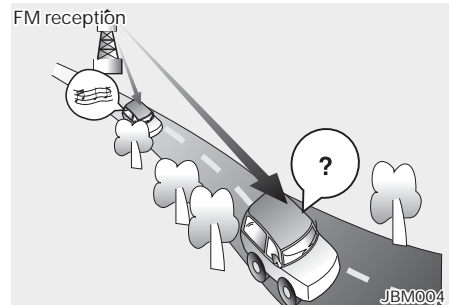

- Fading - As your vehicle moves away from the radio station, the signal will weaken and sound will begin to fade. When this occurs, we suggest that you select another stronger station.
- Flutter/Static - Weak FM signals or large obstructions between the transmitter and your radio can disturb the signal causing static or fluttering noises to occur. Reducing the treble level may lessen this effect until the disturbance clears.

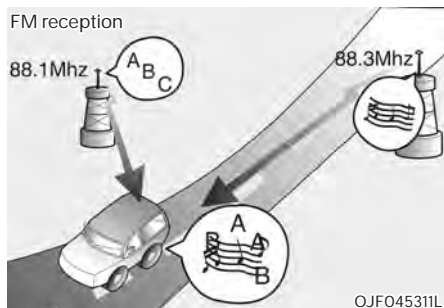

- Multi-Path Cancellation - Radio signals being received from several directions can cause distortion or fluttering. This can be caused by a direct and reflected signal from the same station, or by signals from two stations with close frequencies. If this occurs, select another station until the condition has passed.

### *Using a cellular phone or a two-way radio*

When a cellular phone is used inside the vehicle, noise may be produced from the audio system. This does not mean that something is wrong with the audio equipment. In such a case, use the cellular phone at a place as far as possible from the audio equipment.

### **NOTICE**

**When using a communication system such as a cellular phone or a radio set inside the vehicle, a separate external antenna must be fitted. When a cellular phone or a radio set is used with an internal antenna alone, it may interfere with the vehicle's electrical system and adversely affect safe operation of the vehicle.**

**While listening to the radio, if devices such as laptop charger are connected to the socket, it may generate noise.**

### **WARNING**

**Do not use a cellular phone while driving. Stop at a safe location to use a cellular phone.**

### **iPod®**

iPod® is a registered trademark of Apple Inc.

### **Bluetooth® Wireless Technology**

The Bluetooth® word mark and logos are registered trademarks owned by Bluetooth SIG, Inc. and any use of such marks by HYUNDAI is under license.

Other trademarks and trade names are those of their respective owners.

A Bluetooth® Wireless Technology enabled cell phone is required to use Bluetooth® Wireless Technology.



## AUDIO (WITHOUT TOUCH SCREEN)

### System layout – control panel

■ Type A



#### (1) RADIO button

- Press to display the radio mode selection window.
- When the mode selection window displays, turn the [TUNE] knob to select the desired mode and then press the knob.
- When the Mode Popup is not selected in [MENU/CLOCK] ► Mode Popup, press the [RADIO] button on the control panel to change the mode. Each time you press the [RADIO] button on the control panel, the mode switches to radio FM ► AM in order.

#### (3) FAV button

- While listening to the radio, press to move to next page of the preset list.

#### (4) POWER button/VOL knob

- Press to turn the system on or off.
- Turn to the left or right to adjust the system sound volume.

#### (2) MEDIA button

- Play content from a media storage device.

\* The system's actual appearance and layout may differ depending on the vehicle model and specification.

■ Type A



(5) **SEEK/TRACK button**

- Change the station/track/file.
- While listening to the radio, press and hold to search for a station.
- While playing media, press and hold to rewind or fast forward.

(6) **MENU button/CLOCK button**

- Press to access the menu screen for the current mode.
- Press and hold to access the time setup screen.

(7) **TUNE knob/FILE knob/ENTER button**

- While listening to the radio, turn to adjust the frequency.
- While playing media, turn to search for a track/file.
- While searching by turning the knob, press to select the current track/file.

(8) **Number buttons  
(1 RPT~ 4 BACK)**

- While listening to the radio, press to listen to a saved radio station.
- While listening to the radio, press and hold to save the current radio station to the preset.
- In the USB/Bluetooth audio modes, press the [1 RPT] button to change the repeat play mode. Press the [2 SHFL] button to change the shuffle play mode.
- Press the [4 BACK] button to return to the previous screen (except for the radio preset list).

\* The system's actual appearance and layout may differ depending on the vehicle model and specification.

### ■ Type B



(With Bluetooth® Wireless Technology)

#### (1) **AUDIO button**

- Press to display the radio/media mode selection window.
- When the mode selection window displays, turn the **[TUNE]** knob to select the desired mode and then press the knob.
- When the Mode Popup is not selected in **[MENU/CLOCK] ▶ Mode Popup**, press the **[AUDIO]** button on the control panel to change the mode. Each time you press the **[AUDIO]** button on the control panel, the mode switches to radio ▶ media in order.

#### (2) **PHONE button**

- Press to start connecting a mobile phone via Bluetooth.
- After a Bluetooth phone connection is made, press to access the Bluetooth phone menu.

#### (3) **FAV button**

- While listening to the radio, press to move to next page of the preset list.

#### (4) **POWER button/VOL knob**

- Press to turn the system on or off.
- Turn to the left or right to adjust the system sound volume.

\* The system's actual appearance and layout may differ depending on the vehicle model and specification.

■ Type B



(With Bluetooth® Wireless Technology)

(5) **SEEK/TRACK button**

- Change the station/track/file.
- While listening to the radio, press and hold to search for a station.
- While playing media, press and hold to rewind or fast forward (except for the Bluetooth audio mode).

(6) **MENU button/CLOCK button**

- Press to access the menu screen for the current mode.
- Press and hold to access the time setup screen.

(7) **TUNE knob/FILE knob/ENTER button**

- While listening to the radio, turn to adjust the frequency.
- While playing media, turn to search for a track/file (except for the Bluetooth audio mode).
- While searching by turning the knob, press to select the current track/file (except for the Bluetooth audio mode).

(8) **Number buttons  
(1 RPT~ 4 BACK)**

- While listening to the radio, press to listen to a saved radio station.
- While listening to the radio, press and hold to save the current radio station to the preset.
- In the USB/Bluetooth audio modes, press the **[1 RPT]** button to change the repeat play mode. Press the **[2 SHFL]** button to change the shuffle play mode.
- Press the **[4 BACK]** button to return to the previous screen (except for the radio preset list).

\* The system's actual appearance and layout may differ depending on the vehicle model and specification.

## System layout – steering wheel remote control

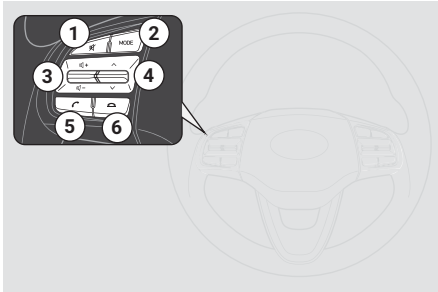

(Bluetooth® equipped model)

\*The system's actual appearance and layout may differ depending on the vehicle model and specification.

### (1) MUTE button

- Press to mute or unmute the system.
- During a call, press to mute or unmute the microphone.
- While playing media, press to pause or resume playback. (if equipped)

### (2) MODE button

- Press to switch between radio and media modes.
- Press and hold to turn the system on or off.

### (3) Volume lever

- Push up or down to adjust the volume.

### (4) Up/Down lever

- Change the station/track/file.
- While listening to the radio, push to listen to the previous/next saved radio station.
- While listening to the radio, push and hold to search for a station.
- While playing media, push and hold to rewind or fast forward (except for the Bluetooth audio mode).

### (5) Call/Answer button

- Press to start connecting a mobile phone via Bluetooth.
- After a Bluetooth phone connection is made, press to access your call history. Press and hold to dial the most recent phone number. When a call comes in, press to answer the call.
- During a call, press to switch between the active call and the held call. Press and hold to switch the call between the system and the mobile phone.

### (6) Call end button

- When a call comes in, reject the call.
- During a call, end the call.



### **WARNING - About driving**

- Do not operate the system while driving. Driving while distracted may result in a loss of vehicle control, potentially leading to an accident, severe personal injury, or death. The driver's primary responsibility is the safe and legal operation of a vehicle, and any handheld devices, equipment, or vehicle systems which divert the driver's attention from this responsibility should never be used during operation of the vehicle.
- Avoid watching the screen while driving. Driving while distracted may lead to a traffic accident. Stop your vehicle in a safe location before using functions that require multiple operations.
- Stop your vehicle first before using your mobile phone. Using a mobile phone while driving may lead to a traffic accident. If necessary, use the Bluetooth Handsfree feature to make calls and keep the call as short as possible.
- Keep the volume low enough to hear external sounds. Driving without the ability to hear external sounds may lead to a traffic accident. Listening to a loud volume for a long time may cause hearing damage.

### **WARNING** - About handling the system

- Do not disassemble or modify the system. Doing so may result in an accident, fire, or electric shock.
- Do not allow liquids or foreign substances to enter the system. Liquids or foreign substances may cause noxious fumes, a fire, or a system malfunction.
- Stop using the system if it malfunctions, such as no audio output or display. If you continue using the system when it is malfunctioning, it may lead to a fire, electric shock, or system failure.
- Do not touch the antenna during thunder or lightning because such an act may cause electric shock.

### **NOTICE**

Manufacturer: HYUNDAI MOBIS Co., Ltd.

203, Teheran-ro, Gangnam-gu, Seoul, 06141, Korea

Tel: +82-31-260-2707

### **Information** - About operating the system

- Use the system with the engine running. Using the system for a long time when the engine is stopped may discharge the battery.
- Do not install unapproved products. Using unapproved products may cause an error while using the system. System errors caused by installing unapproved products are not covered under the warranty.

**i** Information  
- About handling the system

- Do not apply excessive force to the system. Excessive pressure on the screen may damage the LCD panel or the touch panel.
- When cleaning the screen or button panel, make sure to stop the engine and use a soft, dry cloth. Wiping the screen or buttons with a rough cloth or using solvents (alcohol, benzene, paint thinner, etc.) may scratch or chemically damage the surface.
- If you attach a liquid-type air freshener to the fan louver, the surface of the louver may become deformed due to the flowing air.
- If you want to change the position of the installed device, please inquire with your place of purchase or service maintenance center. Technical expertise is required to install or disassemble the device.

**NOTICE**

- If you experience any problems with the system, contact your place of purchase or dealer.
- Placing the infotainment system within an electromagnetic environment may result in noise interference.

Turning the system on or off

To turn on the system, start the engine.

- If you do not want to use the system while driving, you can turn off the system by pressing the [PWR] button on the control panel. To use the system again, press the [PWR] button again.

After you have turned off the engine, the system will automatically turn off after a while or as soon as you open the driver's door.

- Depending on the vehicle model or specifications, the system may turn off as soon as you turn off the engine.
- When you turn back on the system, the previous mode and settings will remain intact.



**WARNING**

- Some functions may be disabled for safety reasons while the vehicle is moving. They work only when the vehicle stops. Park your vehicle in a safe location before using any of them.
- Stop using the system if it malfunctions, such as no audio output or display. If you continue using the system when it is malfunctioning, it may lead to a fire, electric shock, or system failure.



**Information**

You can turn on the system when the key ignition switch is placed in the "ACC" or "ON" position. Using the system for an extended period without the engine running drains the battery. If you plan on using the system for a long time, start the engine.

## Turning the display on or off

To prevent glare, you can turn off the screen. The screen can be turned off only while the system is on.

1. On the control panel, press the [MENU/CLOCK] button.
2. When the option selection window displays, turn the [TUNE] knob to select **Display Off**, and then press the knob.
  - To turn the screen back on, press any of the control panel buttons.

## Getting to know the basic operations

You can select an item or adjust the settings by using the number buttons and the [TUNE] knob on the control panel.

### Selecting an item

#### Numbered items

Press the corresponding number button.

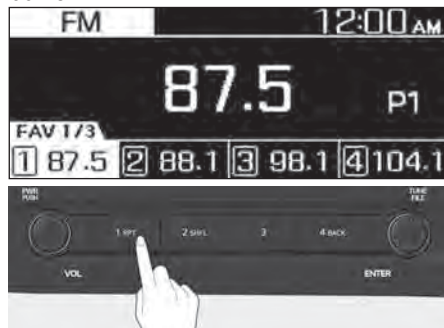

### Numberless items

Turn the [TUNE] knob to select the desired item, and then press the knob.



### Adjusting the settings

Turn the [TUNE] knob to adjust the value, and then press the knob to save changes.

Turn the [TUNE] knob to the right to increase the value and turn the [TUNE] knob to the left to decrease the value.



## RADIO

### Turning on the radio

1. On the control panel, press the [RADIO] / [AUDIO] button.
2. When the mode selection window displays, turn the [TUNE] knob to select the desired radio mode and then press the knob.

#### FM/AM Mode



- (1) Current radio mode
- (2) Radio station information
- (3) Preset list

Press the [MENU/CLOCK] button on the control panel to access the following menu options:

- **Autostore:** Save radio stations to the preset list.
- **Scan:** The system searches for radio stations with strong radio signals and plays each radio station for about five seconds.
- **Sound Settings:** You can change the settings related to sounds, such as location where sound will be concentrated and the output level for each range.
  - **Position:** Select a location where sound will be concentrated in the vehicle. Select **Fade (Fader)** or **Balance**, turn the [TUNE] knob to select the desired position, and then press the knob. To set sound to be centered in the vehicle, select **Centre (Center)**.

- **Equaliser (Tone):** Adjust the output level for each sound tone mode.
- **Speed Dependent Vol.:** Set the volume to be adjusted automatically according to your driving speed.

#### NOTICE

- **Depending on vehicle models or specifications, available options may vary.**
- **Depending on the system or amplifier specifications applied to your vehicle, available options may vary.**
- **Mode Popup:** Set to display mode selection window when the [RADIO] / [AUDIO] button is pressed on the control panel.
- **Date/Time:** You can change the date and time that are shown on the system display.
  - **Set Date:** Set date to display on the system display.
  - **Set Time:** Set time to display on the system display.
  - **Time Format:** Select to display time in the 12 hour format or the 24 hour format.
  - **Display (Power Off):** Set to display the clock when the system power is off.
- **Language:** You can change the display language.
- **Display Off:** Turn off the screen. Press any of the control panel buttons to turn back on.

### FM/AM Mode (With RDS)

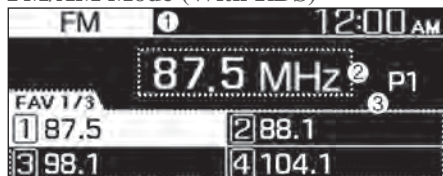

- (1) Current radio mode
- (2) Radio station information
- (3) Preset list

Press the **[MENU/CLOCK]** button on the control panel to access the following menu options:

- **Traffic Announcement:** Activate or deactivate traffic announcements. Announcements and programs will be received automatically if available.
- **Autostore:** Save radio stations to the preset list.
- **Scan:** The system searches for radio stations with strong radio signals and plays each option for about five seconds.
- **Sound Settings:** You can change the settings related to sounds, such as location where sound will be concentrated and the output level for each range.
  - **Position:** Select a location where sound will be concentrated in the vehicle. Select **Fade (Fader)** or **Balance**, turn the **[TUNE]** knob to select the desired position, and then press the knob. To set sound to be centered in the vehicle, select **Centre (Center)**.
  - **Equaliser (Tone):** Adjust the output level for each sound tone mode.
  - **Speed Dependent Vol.:** Set the volume to be adjusted automatically according to your driving speed.

### NOTICE

- Depending on vehicle models or specifications, available options may vary.
- Depending on the system or amplifier specifications applied to your vehicle, available options may vary.
- **Mode Popup:** Set to display mode selection window when the **[RADIO]** / **[AUDIO]** button is pressed on the control panel.
- **Date/Time:** You can change the date and time that are shown on the system display.
  - **Set Date:** Set date to display on the system display.
  - **Set Time:** Set time to display on the system display.
  - **Time Format:** Select to display time in the 12 hour format or the 24 hour format.
  - **Display (Power Off):** Set to display the clock when the system power is off.
- **Language:** You can change the display language.
- **Display Off:** Turn off the screen. Press any of the control panel buttons to turn back on.

### DAB Mode



- (1) Current radio mode
- (2) Radio station information
- (3) Preset list

Press the [MENU/CLOCK] button on the control panel to access the following menu options:

- **Traffic Announcement:** Activate or deactivate traffic announcements. Announcements and programs will be received automatically if available.
- **List:** Display all available radio stations.
- **Scan:** The system searches for radio stations with strong radio signals and plays each option for about five seconds.
- **Sound Settings:** You can change the settings related to sounds, such as location where sound will be concentrated and the output level for each range.
  - **Position:** Select a location where sound will be concentrated in the vehicle. Select **Fade (Fader)** or **Balance**, turn the [TUNE] knob to select the desired position, and then press the knob. To set sound to be centered in the vehicle, select **Centre (Center)**.
  - **Equaliser (Tone):** Adjust the output level for each sound tone mode.
  - **Speed Dependent Vol.:** Set the volume to be adjusted automatically according to your driving speed. (if equipped)

### NOTICE

- Depending on vehicle models or specifications, available options may vary.
- Depending on the system or amplifier specifications applied to your vehicle, available options may vary.
- **Mode Popup:** Set to display mode selection window when the [RADIO] / [AUDIO] button is pressed on the control panel.
- **Date/Time:** You can change the date and time that are shown on the system display.
  - **Set Date:** Set date to display on the system display.
  - **Set Time:** Set time to display on the system display.
  - **Time Format:** Select to display time in the 12 hour format or the 24 hour format.
  - **Display (Power Off):** Set to display the clock when the system power is off.
- **Language:** You can change the display language.
- **Display Off:** Turn off the screen. Press any of the control panel buttons to turn back on.

## Changing the radio mode

1. On the control panel, press the **[RADIO]** / **[AUDIO]** button.
2. When the mode selection window displays, turn the **[TUNE]** knob to select the desired radio mode and then press the knob.
  - Each time you press the **[MODE]** button on the steering wheel, the radio mode switches to FM ► AM in order.

### NOTICE

When the Mode Popup is not selected in **[MENU/CLOCK]** ► Mode Popup, press the **[RADIO]** / **[AUDIO]** button on the control panel to change the radio mode.

Each time you press the **[RADIO]** / **[AUDIO]** button on the control panel, the radio mode switches to FM ► DAB (if equipped) ► AM in order.

## Scanning for available radio stations

You can listen to each radio station for a few seconds to test the reception and select the one you want.

1. From the radio screen, press the **[MENU/CLOCK]** button on the control panel.
2. When the option selection window displays, turn the **[TUNE]** knob to select **Scan**, and then press the knob.
  - The system searches for radio stations with strong radio signals and plays each radio station for about five seconds.
3. When you find the radio station you want to listen to, press the **[TUNE]** knob.
  - You can continue listening to the selected station.

### Searching for radio stations

To search for the previous or next available radio station, press the **[< SEEK]** button / **[TRACK >]** button on the control panel.

- You can also press and hold the **[< SEEK]** button / **[TRACK >]** button to search for frequencies quickly. When you release the button, a radio station with a strong signal is selected automatically.

If you know the exact frequency of the radio station you want to listen to, turn the **[TUNE]** knob on the control panel to change the frequency.

### Saving radio stations

You can save your favorite radio stations and listen to them by selecting them from the preset list.

#### *Saving the current radio station*

While listening to the radio, press and hold the desired number button on the control panel.

- The radio station you are listening to will be added to the selected number.
- To save the next page of the preset list, press the **[FAV]** button.

#### **NOTICE**

- **You can save up to 12 radio stations in each mode.**
- **If a station is already saved to the selected preset number, the station will be replaced by the station you are listening to.**

#### *Using the auto save function*

You can search for radio stations in your area where there is a strong signal. The results of your search can be saved to the preset list automatically.

1. From the radio screen, press the **[MENU/CLOCK]** button on the control panel.
2. When the option selection window displays, turn the **[TUNE]** knob to select **Autostore**, and then press the knob.

### Listening to saved radio stations

#### *FM/AM Mode*

1. Confirm the preset number for the radio station you want to listen to.
  - To view the next page of the preset list, press the **[FAV]** button.
2. On the control panel, press the desired number button.
  - Alternatively, push the Up/Down lever on the steering wheel to change the station.



## MEDIA PLAYER

### Using the media player

You can play music stored in various media storage devices, such as USB storage devices, and smartphones.

1. Connect a device to the USB port in your vehicle.
  - Playback may start immediately depending on the device that you connect to the system.
2. On the control panel, press the [MEDIA] / [AUDIO] button.
3. When the mode selection window displays, turn the [TUNE] knob to select the desired mode and then press the knob.

#### NOTICE

- **To start the media player, press the [MEDIA] / [AUDIO] button on the control panel.**
- **You can also change the mode by pressing the [MODE] button repeatedly on the steering wheel.**
- **Make sure to connect or disconnect external USB devices with the system power turned off.**
- **When the Mode Popup is not selected in [MENU/CLOCK] ► Mode Popup, press the [MEDIA] / [AUDIO] button on the control panel to change the media player.**

Each time you press the [MEDIA] / [AUDIO] button on the control panel, the media mode switches to USB ► BT Audio in order.

- Depending on vehicle models and specifications, available buttons or the appearance and layout of the USB port in your vehicle may vary.

- **Do not connect a smartphone or an MP3 device to the system via multiple methods such as USB and Bluetooth simultaneously. Doing so may cause a distorted noise or a system malfunction.**
- **When the equaliser function of the connected device and Tone settings of the system are both activated, the effects may interfere with each other and may lead to sound degradation or distortion. Deactivate the device's equaliser function if possible.**

### Using the USB mode

You can play media files stored in portable devices, such as USB storage devices and MP3 players. Check compatible USB storage devices and file specifications before using the USB mode.

Connect your USB device to the USB port in the vehicle.

- Playback starts immediately.
- Press the [MEDIA] / [AUDIO] button on the control panel to display the mode selection window, turn the [TUNE] knob to select **USB** and then press the knob.



- (1) Current file number and total number of files
- (2) Playback time
- (3) Information about the song currently playing

Press the **[MENU/CLOCK]** button on the control panel to access the following menu options:

- **List:** Access the file list.
- **Folder List:** Access the folder list.
- **Information:** Display information about the song currently playing.
- **Sound Settings:** You can change the settings related to sounds, such as location where sound will be concentrated and the output level for each range.
  - **Position:** Select a location where sound will be concentrated in the vehicle. Select **Fade (Fader)** or **Balance**, turn the **[TUNE]** knob to select the desired position, and then press the knob. To set sound to be centered in the vehicle, select **Centre (Center)**.
  - **Equaliser (Tone):** Adjust the output level for each sound tone mode.
  - **Speed Dependent Vol.:** Set the volume to be adjusted automatically according to your driving speed.

### NOTICE

- Depending on vehicle models or specifications, available options may vary.
- Depending on the system or amplifier specifications applied to your vehicle, available options may vary.

- **Song information (Media Display):** Select information such as **Folder/File** or **Artist/Title/Album** to display when playing MP3 files.

- **Mode Pop-up:** Set to display mode selection window when the **[MEDIA]** / **[AUDIO]** button is pressed on the control panel.

- **Date/Time:** You can change the date and time that are shown on the system display.

- **Set Date:** Set date to display on the system display.

- **Set Time:** Set time to display on the system display.

- **Time Format:** Select to display time in the 12 hour format or the 24 hour format.

- **Display (Power Off):** Set to display the clock when the system power is off.

- **Language:** You can change the display language.

- **Display Off:** Turn off the screen. Press any of the control panel buttons to turn back on.

### Rewinding/Fast forwarding

On the control panel, press and hold the **[< SEEK]** button / **[TRACK >]** button.

- You can also push and hold the Up/Down lever on the steering wheel.

### *Restarting the current playback*

On the control panel after the song has played for 2 seconds, press the [**< SEEK**] button.

- You can also push the Up lever on the steering wheel.

### *Playing the previous or next song*

To play the previous song on the control panel within the first 2 seconds of the current song, press the [**< SEEK**] button. To play the next song, press the [**TRACK >**] button on the control panel.

- If more than 2 seconds of playback have elapsed, press the [**< SEEK**] button on the control panel twice to play the previous song.
- You can also push the Up/Down lever on the steering wheel.

### **NOTICE**

Select [**MENU/CLOCK**] > List to access the file list, turn the [**TUNE**] knob to find the desired song and press the knob to play the file.

### *Playing repeatedly*

On the control panel, press the [**1 RPT**] button. The repeat play mode changes each time you press it. The corresponding mode icon will be displayed on the screen.

### *Playing in random order*

On the control panel, press the [**2 SHFL**] button. The shuffle play mode is activated or deactivated each time you press it. When you activate the shuffle mode, the corresponding mode icon will be displayed on the screen.

### **NOTICE**

**Depending on the connected Bluetooth device or mobile phone, RPT & SHFL features may not be supported.**

### *Searching folders*

1. On the control panel, press the [**MENU/CLOCK**] button.
2. When the option selection window displays, turn the [**TUNE**] knob to select the **Folder List** and then press the knob.
3. Navigate to the desired folder in the **Folder List** and then press the [**TUNE**] knob.
  - The first song in the selected folder will be played.



### **Information**

- **Start the engine of your vehicle before connecting a USB device to your system. Starting the engine with a USB device connected to the system may damage the USB device.**
- **Be careful of static electricity when connecting or disconnecting a USB device. A static discharge may cause a system malfunction.**
- **Be careful not to let your body or external objects contact the USB port. Doing so may cause an accident or a system malfunction.**
- **Do not connect and disconnect a USB connector repeatedly in a short time. Doing so may cause an error in the device or a system malfunction.**
- **Do not use a USB device for purposes other than playing files. Using USB accessories for charging or heating may cause poor performance or a system malfunction.**

**NOTICE**

- **When connecting a USB storage device, do not use an extension cable. Connect it directly to the USB port. If you use a USB hub or an extension cable, the device may not be recognized.**
- **Fully insert a USB connector into the USB port. Failure to do so may cause a communication error.**
- **When you disconnect a USB storage device, a distorted noise may occur.**
- **The system can play only files encoded in a standard format.**
- **The following types of USB devices may not be recognized or work correctly:**
  - Encrypted MP3 players
  - USB devices not recognized as removable disks
- **A USB device may not be recognized depending on its condition.**
- **Some USB devices may be incompatible with your system.**
- **Depending on the USB device's type, capacity, or the format of files, USB recognition time may be longer.**
- **Image and video playback are not supported.**

## BLUETOOTH

### Connecting Bluetooth devices

Bluetooth is a short-range wireless networking technology. Via Bluetooth, you can connect nearby mobile devices wirelessly to send and receive data between connected devices. This enables you to use your devices effectively.

To use Bluetooth, you must first connect a Bluetooth-enabled device to your system, such as a mobile phone or an MP3 player. Ensure that the device you want to connect supports Bluetooth.



**WARNING**

**Park your vehicle in a safe location before connecting Bluetooth devices. Distracted driving can cause a traffic accident and lead to personal injury or death.**

**NOTICE**

- **On your system, you can use only Bluetooth Handsfree and Audio features. Connect a mobile device that supports both features.**
- **Some Bluetooth devices may cause malfunctions to the infotainment system or make interference noises. In this case, storing the device in a different location may resolve the problem.**
- **Depending on the connected Bluetooth device or mobile phone, some functions may not be supported.**
- **If the system is not stable due to a vehicle-Bluetooth device communication error, delete the paired devices and connect the Bluetooth devices again.**

- If Bluetooth connection is not stable, follow these steps to try again.
  1. Deactivate Bluetooth and reactivate it on the device. Then, reconnect the device.
  2. Turn the device off and on. Then, reconnect it.
  3. Remove the battery from the device and reinstall it. Then, turn the device on and reconnect it.
  4. Unregister the Bluetooth pairing on both the system and the device and then re-register and connect them.
- The Bluetooth connection is unavailable when the device's Bluetooth function is turned off. Be sure to turn on the device's Bluetooth function.

### *Pairing devices with your system*

For Bluetooth connections, first pair your device with your system to add it to the system's list of Bluetooth devices. You can register up to five devices.

1. From the control panel, press the [PHONE] button, and then select **Phone Settings ► Add New Device**.
  - If you are pairing a device with your system for the first time, you can also press the Call/Answer button on the steering wheel.
2. On the Bluetooth device you want to connect, activate Bluetooth, search for your vehicle's system, and then select it.
  - Check the system's Bluetooth name, which is displayed in the new registration pop-up window on the system screen.

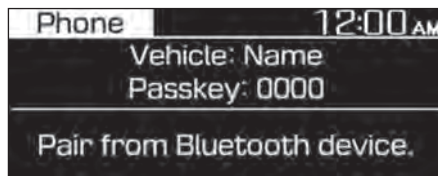

3. Enter or confirm the passkey to confirm the connection.
  - If the passkey input screen is displayed on the Bluetooth device screen, enter the passkey '0000' which is displayed on the system screen.
  - If the 6-digit passkey is displayed on the Bluetooth device screen, ensure that the Bluetooth passkey displayed on the Bluetooth device is the same as the passkey on the system screen and confirm the connection from the device.

### **NOTICE**

- The screen image in this manual is an example. Check your system screen for the exact vehicle name and Bluetooth device name.
- The default passkey is '0000'.
- It may take a while for the system to connect with the device after you permit the system to access the device. When a connection is made, the Bluetooth status icon appears at the top of the screen.
- You can change the permission settings via the mobile phone's Bluetooth settings menu. For more information, refer to your mobile phone's user guide.
- To register a new device, repeat steps 1 to 3.

- If you use the automatic Bluetooth connection function, a call may be switched to the vehicle's Handsfree when you are taking on the phone near the vehicle while the vehicle's engine is on. If you do not want the system to connect with the device automatically, deactivate Bluetooth on your device.
- When a device is connected to the system via Bluetooth, the device's battery may discharge faster.

### *Connecting a paired device*

To use a Bluetooth device on your system, connect the paired device to the system. Your system can connect with only one device at a time.

1. From the control panel, press the [PHONE] button, and then select **Phone Settings ► Paired Devices**.
  - If there is no connected device, press the Call/Answer button on the steering wheel.
2. Turn the [TUNE] knob to select the device to connect, and then press the knob.
  - If another device is already connected to your system, disconnect it. Select the connected device to disconnect.

### **NOTICE**

- If a connection ends because a device is out of the connection range or a device error occurs, the connection will be restored automatically when the device enters the connection range or when the error is cleared.
- Depending on auto connection priority, connection to a device may take time.

### *Disconnecting a device*

If you want to stop using a Bluetooth device or connect another device, disconnect your currently connected device.

1. From the control panel, press the [PHONE] button, and then select **Phone Settings ► Paired Devices**.
2. Turn the [TUNE] knob to select your currently connected device and then press the knob.
3. Press the [1 RPT] button to select **Yes**.

### *Deleting paired devices*

If you no longer want a Bluetooth device paired or if you want to connect a new device when the Bluetooth device list is full, delete paired devices.

1. From the control panel, press the [PHONE] button, and then select **Phone Settings ► Delete Devices**.
2. Turn the [TUNE] knob to select the device to delete, and then press the knob.
3. Press the [1 RPT] button to select **Yes**.

**NOTICE**

- **When you delete a paired device, the Call history and Contacts stored in the system are also deleted.**
- **To re-use a deleted device, you must pair the device again.**

**Using a Bluetooth audio device**

You can listen to music stored in the connected Bluetooth audio device via your vehicle's speakers.

1. On the control panel, press the [AUDIO] button.
2. When the mode selection window displays, turn the [TUNE] knob to select **BT Audio** and then press the knob.



- (1) Information about the song currently playing

1. Press the [MENU/CLOCK] button on the control panel to access the following a menu option.
2. Turn the [TUNE] knob to select option and then press the knob.

- **Sound Settings:** You can change the settings related to sounds, such as location where sound will be concentrated and the output level for each range.
  - **Position:** Select a location where sound will be concentrated in the vehicle. Select **Fade (Fader)** or **Balance**, turn the [TUNE] knob to select the desired position, and then press the knob. To set sound to be centered in the vehicle, select **Centre (Center)**.
  - **Equaliser (Tone):** Adjust the output level for each sound tone mode.
  - **Speed Dependent Vol.:** Set the volume to be adjusted automatically according to your driving speed.

**NOTICE**

- **Depending on vehicle models or specifications, available options may vary.**
- **Depending on the system or amplifier specifications applied to your vehicle, available options may vary.**
- **Mode Popup:** Set to display mode selection window when the [AUDIO] button is pressed on the control panel.
- **Date/Time:** You can change the date and time that are shown on the system display.
  - Set Date: Set date to display on the system display.
  - Set Time: Set time to display on the system display.

- **Time Format:** Select to display time in the 12 hour format or the 24 hour format.
- **Display (Power Off):** Set to display the clock when the system power is off.
- **Language:** You can change the display language.
- **Display Off:** Turn off the screen. Press any of the control panel buttons to turn back on.

### *Pausing/Resuming playback*

To pause playback, press the [TUNE] knob on the control panel. To resume playback, press the [TUNE] knob again.

- You can also press the Mute button on the steering wheel remote control.

### *Playing repeatedly*

On the control panel, press the [1 RPT] button. The repeat play mode changes each time you press it. The corresponding mode icon will be displayed on the screen.

### *Playing in random order*

On the control panel, press the [2 SHFL] button. The shuffle play mode is activated or deactivated each time you press it. When you activate the shuffle mode, the corresponding mode icon will be displayed on the screen.

### **NOTICE**

Depending on the connected Bluetooth device or mobile phone, RPT & SHFL features may not be supported.

### **NOTICE**

- Depending on the connected Bluetooth device, mobile phone, or the music player you are using, playback controls may differ.
- Depending on the music player you are using, streaming may not be supported.
- Depending on the connected Bluetooth device or mobile phone, some functions may not be supported.
- If a Bluetooth enabled phone is being used to play music and it receives or makes a phone call, the music will stop.
- Receiving an incoming call or making an outgoing call while playing Bluetooth audio may result in audio interference.
- If you use the Bluetooth phone mode while using Bluetooth audio, playback may not automatically resume after you end the call depending on the connected mobile phone.
- Moving the track up/down while playing Bluetooth audio mode may result in pop noises with some mobile phones.
- The Rewinding/Fast forwarding function is not supported in the Bluetooth audio mode.
- The playlist feature is not supported in the Bluetooth audio mode.
- If the Bluetooth device is disconnected, Bluetooth audio mode will end.



## Using a Bluetooth phone

You can use Bluetooth to talk on the phone hands free. View call information on the system screen, and make or receive calls safely and conveniently via the vehicle's built-in microphone and speakers.



### WARNING

- **Park your vehicle in a safe location before connecting Bluetooth devices. Distracted driving can cause a traffic accident and lead to personal injury or death.**
- **Never dial a phone number or pick up your mobile phone while driving. Use of a mobile phone may distract your attention, making it difficult to recognize external conditions and reducing the ability to cope with unexpected situations, which may lead to an accident. If necessary, use the Bluetooth Handsfree feature to make calls and keep the call as short as possible.**

### NOTICE

- **You cannot access the Phone screen if there is no connected mobile phone. To use the Bluetooth phone function, connect a mobile phone to the system.**
- **The Bluetooth Handsfree function may not work when you are passing out of the cellular service coverage area, such as when you are in a tunnel, underground, or in a mountainous area.**
- **Call quality may be degraded in the following environments:**
  - The reception of the mobile phone is poor
  - The inside of the vehicle is noisy
  - The mobile phone is placed near metallic objects, such as a beverage can.
- **Depending on the connected mobile phone, the volume and sound quality of the Bluetooth Handsfree may vary.**

### Making a call

If your mobile phone is connected to the system, you can make a call by selecting a name from your call history or contacts list.

1. On the control panel, press the **[PHONE]** button.
  - Alternatively, press the Call/Answer button on the steering wheel.
2. Select a phone number.
  - To select a phone number from your favorites list, select **Favorites**.
  - To select a phone number from your call history, select **Call History**.
  - To select a phone number from the contacts list downloaded from the connected mobile phone, select **Contacts**.
3. To end the call, press the **[2 SHFL]** button on the control panel.
  - Alternatively, press the Call end button on the steering wheel.

### Registering the favorites list

You can more easily use Bluetooth to talk on the phone hands-free by registering phone numbers as your favorites.

1. On the Phone screen, turn the **[TUNE]** knob on the control panel to select **Favorites** and press the knob.
2. Select **Add New**.
3. Turn the **[TUNE]** knob to select the desired group of alphanumeric characters, and then press the knob.
4. Turn the **[TUNE]** knob to select the desired contact.

### Using the favorites list

1. From the Phone screen, turn the **[TUNE]** knob on the control panel to select **Favorites**, and then press the knob.
2. Turn the **[TUNE]** knob to select the desired contact, and then press the knob to make a phone call.

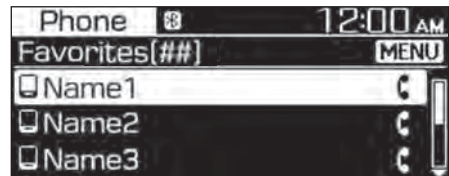

Press the **[MENU/CLOCK]** button on the control panel to access the following menu options:

- **Add new favorites:** Add a frequently used phone number to favorites.
- **Delete Items:** Delete a selected favorites item.
- **Delete All:** Delete all favorites items.

### NOTICE

- **You can register up to 20 favorites for each device.**
- **You must first download the contacts to the system to register favorites.**
- **The favorites list saved on the mobile phone is not downloaded to the system.**
- **Even if the contact information on the mobile phone is edited, the favorites on the system are not automatically edited. Delete and add the item to favorites again.**
- **When you connect a new mobile phone, your favorites set for the previous mobile phone will not be displayed, but they will remain in your system until you delete the previous phone from the device list.**

### Using your call history

1. From the Phone screen, turn the [TUNE] knob on the control panel to select **Call History**, and then press the knob.
2. Turn the [TUNE] knob to select the desired entry, and then press the knob to make a phone call.

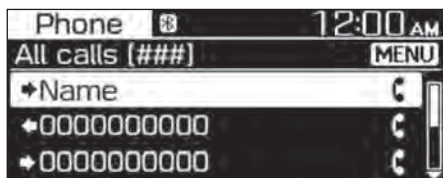

Press the [MENU/CLOCK] button on the control panel to access the following menu options:

- **Download:** Download your call history.
- **All Calls:** View all call records.
- **Dialed Calls:** View only dialed calls.
- **Received Calls:** View only received calls.
- **Missed Calls:** View only missed calls.

### NOTICE

- **Some mobile phones may not support the download function.**
- **The call history is accessed only after downloading the call history when the mobile phone is connected to the system.**
- **Calls from restricted IDs are not saved on the call history list.**
- **Up to 50 call records will be downloaded per individual list.**
- **Call duration and time information will not be displayed on the system screen.**
- **Permission is required to download your call history from the mobile phone. When you attempt to download data, you may need to permit the download on the mobile phone. If the download fails, check the mobile phone screen for any notification or the mobile phone's permission setting.**
- **When you download your call history, any old data will be deleted.**

### Using the contacts list

1. From the Phone screen, turn the [TUNE] knob on the control panel to select **Contacts**, and then press the knob.
2. Turn the [TUNE] knob to select the desired group of alphanumeric characters, and then press the knob.
3. Turn the [TUNE] knob to select the desired contact, and then press the knob to make a phone call.



Press the [MENU/CLOCK] button on the control panel to access the following a menu option:

- **Download:** Download your mobile phone contacts.

**NOTICE**

- **Contacts can be viewed only when the Bluetooth device is connected.**
- **Only contacts in the supported format can be downloaded and displayed from the Bluetooth device. Contacts from some applications will not be included.**
- **Up to 2,000 contacts can be downloaded from your device.**
- **Some mobile phones may not support the download function.**
- **Depending on the system's specifications, some of the downloaded contacts may be lost.**
- **Contacts stored both in the phone and in the SIM card are downloaded. With some mobile phones, contacts in the SIM card may not be downloaded.**
- **Special characters and figures used in the contact name may not be displayed properly.**

- **Permission is required to download contacts from the mobile phone. When you attempt to download data, you may need to permit the download on the mobile phone. If the download fails, check the mobile phone screen for any notification or the mobile phone's permission setting.**
- **Depending on the mobile phone type or status, downloading may take longer.**
- **When you download your contacts, any old data will be deleted.**
- **You cannot edit or delete your contacts on the system.**
- **When you connect a new mobile phone, your contacts downloaded from the previous mobile phone will not be displayed, but they will remain in your system until you delete the previous phone from the device list.**

*Answering calls*

When a call comes in, a notification pop-up window of the incoming call appears on the system screen.



To answer the call, press the [1 RPT] button on the control panel.

- Alternatively, press the Call/ Answer button on the steering wheel.

To reject the call, press the [2 SHFL] button on the control panel.

- Alternatively, press the Call end button on the steering wheel.

### NOTICE

- Depending on the mobile phone type, call rejection may not be supported.
- Once your mobile phone is connected to the system, the call sound may be output through the vehicle's speakers even after you exit the vehicle if the phone is within the connection range. To end the connection, disconnect the device from the system or deactivate Bluetooth on the device.

### Using options during a call

During a call, you will see the call screen shown below. Press a button to perform the function you want.

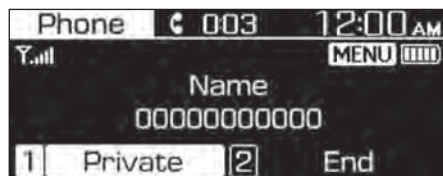

To switch the call to your mobile phone, press the [1 RPT] button on the control panel.

- Alternatively, press and hold the Call/Answer button on the steering wheel.

To end the call, press the [2 SHFL] button on the control panel.

- Alternatively, press the Call end button on the steering wheel.

Press the [MENU/CLOCK] button on the control panel to access the following a menu option:

- **Microphone Volume (Outgoing Volume):** Adjust the microphone volume or turn off the microphone so the other party cannot hear you.

### NOTICE

- If the caller information is saved in your contacts list, the caller's name and phone number will be displayed. If the caller information is not saved in your contacts list, only the caller's phone number will be displayed.
- You cannot switch to any other screen, such as the audio screen or the settings screen, during a Bluetooth call.
- Depending on the mobile phone type, call quality may vary. On some phones, your voice may be less audible to the other party.
- Depending on the mobile phone type, the phone number may not be displayed.
- Depending on the mobile phone type, the call switching function may not be supported.

## THE EMERGENCY CALL SERVICE (IF EQUIPPED)

You can make an emergency call quickly in the event of a traffic accident via the emergency call system.

- Public Safety Answering Point (PSAP) emergency call service

### *SOS*

Driver or passenger manually can make an emergency call in the single duty dispatch service, by pressing SOS button to call the necessary emergency services.

- Stops sound and SOS is displayed on screen.

### **NOTICE**

- **For more information, refer to the “Emergency situations” in manual.**
- **Depending on your region, the service may not be supported.**
- **Depending on your region or vehicle model, the name of the button may vary.**





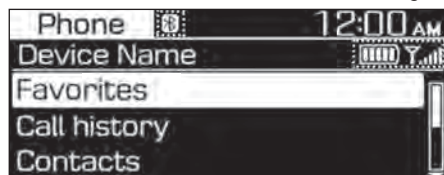

## SYSTEM STATUS ICONS

Status icons appear at the top of the screen to display the current system status.

Familiarise yourself with the status icons that appear when you perform certain actions or functions and their meanings.



### Bluetooth

Icon	Description
	Battery level of connected Bluetooth device
	Mobile phone or audio device connected via Bluetooth
	Bluetooth call in progress
	Microphone turned off during Bluetooth call
	Downloading call history from a mobile phone connected via Bluetooth to the system
	Downloading contacts from a mobile phone connected via Bluetooth to the system

### Signal strength

Icon	Description
	Signal strength of the mobile phone connected via Bluetooth

### NOTICE

- The battery level displayed on the screen may differ from the battery level displayed on the connected device.
- The signal strength displayed on the screen may differ from the signal strength displayed on the connected mobile phone.
- Depending on vehicle models and specifications, some status icons may not be displayed.

## INFOTAINMENT SYSTEM SPECIFICATIONS

### USB

#### *Supported audio formats*

Audio file specification

- WAVeform audio format
- MPEG1/2/2.5 Audio Layer3
- Windows Media Audio Ver 7.X/8.X

Bit rates

- MPEG1 (Layer3):  
32/40/48/56/64/80/96/112/128/  
160/192/224/256/320 kbps
- MPEG2 (Layer3):  
8/16/24/32/40/48/56/64/80/96/  
112/128/144/160 kbps
- MPEG2.5 (Layer3):  
8/16/24/32/40/48/56/64/80/96/  
112/128/144/160 kbps
- WMA (High Range):  
48/64/80/96/128/160/192 kbps
- Bits Per Sample
  - WAV (PCM(Stereo)): 24 bit
  - WAV (IMA ADPCM): 4 bit
  - WAV (MS ADPCM): 4 bit
- Sampling frequency
  - MPEG1: 44100/48000/32000 Hz
  - MPEG2: 22050/24000/16000 Hz
  - MPEG2.5: 11025/12000/8000 Hz
  - WMA: 32000/44100/48000 Hz
  - WAV: 44100/48000 Hz
- Maximum length of folder/file names  
(Based on Unicode): 40 English or  
Korean characters
- Supported characters for folder/  
file names (Unicode support): 2,604  
Korean characters, 94 alphanumeric  
characters, 4,888 Chinese characters  
in common use, 986 special  
characters
- Maximum number of folders: 1,000
- Maximum number of files: 5,000

### **NOTICE**

- Files that are not in a supported format may not be recognized or played, or information about them, such as the file name, may not be displayed properly.
- Only files with .mp3/.wma/.wav extensions can be recognized by the system. If the file is not in supported format, change the file format by using the latest encoding software.
- The device will not support files locked by DRM (Digital Rights Management).
- For MP3/WMA compression files and WAV file, differences in sound quality will occur depending on the bitrate. (Music files with a higher bitrate have a better sound quality.)
- Japanese or Simplified Chinese characters in folder or file names may not be displayed properly.

#### *Supported USB storage devices*

- Byte/Sector: 64 kbyte or less
- Format system: FAT12/16/32 (recommended), exFAT/NTFS



**NOTICE**

- **Operation is guaranteed only for a metal cover type USB storage device with a plug type connector.**
  - **USB storage devices with a plastic plug may not be recognized.**
  - **USB storage devices in memory card types, such as CF card or SD cards, may not be recognized.**
- **USB hard disk drives may not be recognized.**
- **When you use a large capacity USB storage device with multiple logical drives, only files stored on the first drive will be recognized.**
- **If an application program is loaded on a USB storage device, the corresponding media files may not play.**
- **Use USB 2.0 devices for better compatibility.**

**Bluetooth**

- Bluetooth Power Class 2: -6 to 4 dBm
- Aerial power: Max 2.5 mW
- Frequency range: 2400 to 2483.5 MHz
- Bluetooth patch RAM software version: 1

**TRADEMARKS**

Other trademarks and trade names are those of their respective owners.

- The Bluetooth® word mark and logos are registered trademarks owned by Bluetooth SIG, Inc. and any use of such marks by HYUNDAI is under licence.



# DECLARATION OF CONFORMITY

CE

## EU Declaration of Conformity <sup>[1]</sup>



### Product details <sup>[2]</sup>

**Product** <sup>[3]</sup> Car Audio System

**Model** <sup>[4]</sup> ACB10HQIG, ACB11HQIG, ACB12HQIG, ACB13HQIG, ACB10HQGG, ACB10HQGN, ACB10HQGL, ACB10HQGP, ACB11HQGG, ACB10HQMG, ACB00GQTP, ACB11GQTP, ACB00GQEG, ACB01GQEG, ACB90GQEG, ACB10GQEG, ACB11GQEG, ACB00GQEP, ACB00GQEP, ACB90GQEP, ACB10GQEP, ACB00GQEP, ACB11GQEP, ACBC1GQEP, ACB91GQEP, ACB02GQEP, AU210HQEP, AU211HQEP

We hereby declare, that the product above is in compliance with the essential requirements of the Directive 2014/53/EU by application of <sup>[5]</sup>

### Applied Standards <sup>[6]</sup>

**Article** <sup>[7]</sup> **3.2**  
**Radio** <sup>[8]</sup> EN 300 328 V2.2.2, EN 303 345-1 V1.1.1, EN 303 345-2 V1.2.1,  
EN 303 345-3 V1.1.1 EN 303 345-4 V1.1.1

**Article** <sup>[7]</sup> **3.1b**  
**EMC** <sup>[9]</sup> EN 301 489-1 V2.2.3, EN 301 489-17 V3.2.4  
EN 55032:2015+A11:2020, EN 55035:2017+A11:2020

**Article** <sup>[7]</sup> **3.1a**  
**Safety** <sup>[10]</sup>, **Health** <sup>[11]</sup> EN IEC 62368 - 1:2020+A11:2020  
EN 62311:2008

### Manufacturer <sup>[12]</sup>

Hyundai MOBIS Co., Ltd.  
203, Teheran-ro, Gangnam-gu,  
Seoul, 06141 , Korea  
Tel: +82-31-260-2707

### Representative in the EU <sup>[13]</sup>

MOBIS Parts Europe N.V.  
Wilhelm-Fay-Strabe 51,  
Frankfurt Main, 65936, Germany  
Tel: +49-69-85096-5011

**Signed By** <sup>[14]</sup> 25/07/2022

This declaration of conformity is issued under the sole responsibility of the manufacturer. <sup>[15]</sup>



Seunghoon Choe  
Representative  
Hyundai MOBIS Co., Ltd.

## IFETEL

“La operación de este equipo está sujeta a las siguientes dos condiciones: (1) es posible que este equipo o dispositivo no cause interferencia perjudicial y (2) este equipo o dispositivo debe aceptar cualquier interferencia, incluyendo la que pueda causar su operación no deseada.”

## TRA

---

OMAN-TRA

---

D192564

---

TRA/TA-R/7402/19

---



# 6. Driving Your Vehicle

Before driving.....	6-3
Before entering the vehicle .....	6-3
Before starting.....	6-3
Ignition switch.....	6-4
Key ignition switch .....	6-4
Engine Start/Stop button.....	6-7
Manual transmission .....	6-12
Manual transmission operation.....	6-12
Good driving practices.....	6-14
Automated Manual Transmission (AMT) .....	6-15
Automated Manual Transmission (AMT) operation .....	6-16
Features of the Automated Manual Transmission (AMT) .....	6-16
Parking .....	6-24
Good driving practices.....	6-24
Braking system.....	6-26
Power brakes .....	6-26
Disc brakes wear indicator .....	6-26
Rear drum brakes .....	6-27
Parking brake.....	6-27
Anti-lock Brake System (ABS).....	6-29
Electronic Stability Control (ESC) .....	6-30
Vehicle Stability Management (VSM) .....	6-33
Hill-Start Assist Control (HAC).....	6-34
Emergency Stop Signal (ESS).....	6-35
Brake Assist System (BAS) .....	6-35
Good braking practices.....	6-36
Special driving conditions.....	6-37
Hazardous driving conditions .....	6-37
Rocking the vehicle.....	6-37
Smooth cornering .....	6-38
Driving at night.....	6-38
Driving in the rain .....	6-38
Driving in flooded areas.....	6-39
Winter driving.....	6-40
Snow or icy conditions.....	6-40
Winter precautions.....	6-42
Vehicle weight.....	6-44
Overloading .....	6-44



**WARNING**

**Carbon monoxide (CO) gas is toxic. Breathing CO can cause unconsciousness and death.**

Engine exhaust contains carbon monoxide which cannot be seen or smelled.

**Do not inhale engine exhaust.**

If at any time you smell engine exhaust inside the vehicle, open the windows immediately. Exposure to CO can cause unconsciousness and death by asphyxiation.

**Be sure the exhaust system does not leak.**

The exhaust system should be checked whenever the vehicle is raised to change the oil or for any other purpose. If you hear a change in the sound of the exhaust or if you drive over something that strikes the underneath side of the vehicle, we recommend that the exhaust system be checked as soon as possible by an authorized HYUNDAI dealer.

**Do not run the engine in an enclosed area.**

Letting the engine idle in your garage, even with the garage door open, is a hazardous practice. Run the engine only long enough to start the engine and to move the vehicle out of the garage.

**Avoid idling the engine for prolonged periods with people inside the vehicle.**

If it is necessary to idle the engine for a prolonged period with people inside the vehicle, be sure to do so only in an open area with the air intake set at "Fresh" and fan control set to high so fresh air is drawn into the interior.

**Keep the air intakes clear.**

To assure proper operation of the ventilation system, keep the ventilation air intakes located in front of the windshield clear of snow, ice, leaves, or other obstructions.

**If you must drive with the tailgate/trunk open:**

Close all windows.

Open instrument panel air vents.

Set the air intake control at "Fresh", the air flow control at "Floor" or "Face", and the fan control set to high.

## BEFORE DRIVING

### Before entering the vehicle

- Be sure all windows, outside mirror(s) and outside lights are clean and unobstructed.
- Remove frost, snow or ice.
- Visually check the tires for uneven wear and damage.
- Check under the vehicle for any sign of leaks.
- Be sure there are no obstacles behind you if you intend to back up.

### Before starting

- Make sure the hood, the tailgate/trunk and the doors are securely closed and locked.
- Adjust the position of the seat and steering wheel.
- Adjust the inside and outside rearview mirrors.
- Verify all of the lights work.
- Fasten your seatbelt. Check that all passengers have fastened their seatbelts.
- Check the gauges and indicators in the instrument panel and the messages on the instrument display when the ignition switch is in the ON position.
- Check that any items you are carrying are stored properly or fastened down securely.



### WARNING

To reduce the risk of **SERIOUS INJURY** or **DEATH**, take the following precautions:

- **ALWAYS** wear your seat belt. All passengers must be properly belted whenever the vehicle is moving. For more information, refer to “Seat Belts” in chapter 3.
- Always drive defensively. Assume other drivers or pedestrians may be careless and make mistakes.

- Stay focused on the task of driving. Driver distraction can cause accidents.
- Leave plenty of space between you and the vehicle in front of you.



### WARNING

**NEVER** drink or take drugs and drive. Drinking or taking drugs and driving is dangerous and may result in an accident and **SERIOUS INJURY** or **DEATH**.

Drunk driving is the number one contributor to the highway death toll each year. Even a small amount of alcohol will affect your reflexes, perceptions and judgment. Just one drink can reduce your ability to respond to changing conditions and emergencies and your reaction time gets worse with each additional drink.

Driving while under the influence of drugs is as dangerous as or more dangerous than driving under the influence of alcohol.

You are much more likely to have a serious accident if you drink or take drugs and drive. If you are drinking or taking drugs, don't drive. Do not ride with a driver who has been drinking or taking drugs. Choose a designated driver or call a taxi.

## IGNITION SWITCH

### WARNING

To reduce the risk of **SERIOUS INJURY** or **DEATH**, take the following precautions:

- NEVER allow children or any person who is unfamiliar with the vehicle to touch the ignition switch or related parts. Unexpected and sudden vehicle movement can occur.
- NEVER reach through the steering wheel for the ignition switch, or any other controls, while the vehicle is in motion. The presence of your hand or arm in this area may cause a loss of vehicle control resulting in an accident.

### Key ignition switch (if equipped)

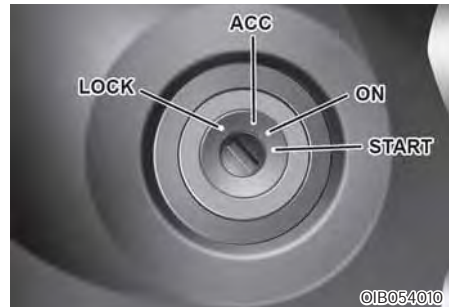

### WARNING

- NEVER turn the ignition switch to the LOCK or ACC position while the vehicle is in motion except in an emergency. This will result in the engine turning off and loss of power assist for the steering and brake systems.  
This may lead to loss of directional control and braking function, which could cause an accident.
- Before leaving the driver's seat, always make sure the shift lever is in the 1st gear (for manual transmission vehicle) or N (Neutral) position (for Automated Manual Transmission vehicle), apply the parking brake, and turn the ignition switch to the LOCK position.  
Unexpected vehicle movement may occur if these precautions are not followed.



**Key ignition switch positions**

Switch Position	Action	Notice
<b>LOCK</b>	The ignition key can be removed in the LOCK position.	The steering wheel locks to protect the vehicle from theft. (If equipped)
<b>ACC</b>	Electrical accessories are usable.	The steering wheel unlocks. If difficulty is experienced turning the ignition switch to the ACC position, turn the key while turning the steering wheel right and left to release tension.
<b>ON</b>	This is the normal key position when the engine has started. All features and accessories are usable. The warning lights can be checked when you turn the ignition switch from ACC to ON.	Do not leave the ignition switch in the ON position when the engine is not running to prevent the battery from discharging.
<b>START</b>	To start the engine, turn the ignition switch to the START position. The switch returns to the ON position when you let go of the key.	The engine will crank until you release the key.

### *Starting the engine*



#### **WARNING**

- **Always wear appropriate shoes when operating your vehicle. Unsuitable shoes, such as high heels, ski boots, sandals, flip-flops, etc., may interfere with your ability to use the brake, accelerator and clutch pedals.**
- **Do not start the vehicle with the accelerator pedal depressed. The vehicle can move and lead to an accident.**
- **Wait until the engine RPM is normal. The vehicle may suddenly move if the brake pedal is released when the RPM is high.**

### **Starting the gasoline engine**

Vehicle with Manual Transmission:

1. Make sure the parking brake is applied.
2. Make sure the shift lever is in N (Neutral).
3. Depress the clutch and brake pedals.
4. Turn the ignition switch to the START position. Hold the key (maximum of 10 seconds) until the engine starts and release it.

Vehicle with Automated Manual Transmission :

1. Make sure the parking brake is applied.
2. Make sure the shift lever is in N (Neutral).
3. Depress the brake pedal firmly.
4. Turn the ignition switch to the START position. Hold the key (maximum of 10 seconds) until the engine starts and release it. The engine can not be started unless the shift lever is 'N' position.

## **i** Information

- Do not wait for the engine to warm up while the vehicle remains stationary. Start driving at moderate engine speeds. (Steep accelerating and decelerating should be avoided.)
- Always start the vehicle with your foot on the brake pedal. Do not depress the accelerator while starting the vehicle. Do not race the engine while warming it up.

## **NOTICE**

To prevent damage to the vehicle:

- Do not hold the ignition key in the START position for more than 10 seconds. Wait 5 to 10 seconds before trying again.
- Do not turn the ignition switch to the START position with the engine running. It may damage the starter.
- If traffic and road conditions permit, you may put the shift lever in the N (Neutral) position while the vehicle is still moving and turn the ignition switch to the START position in an attempt to restart the engine.
- Do not push or tow your vehicle to start the engine.

## Engine Start/Stop button (if equipped)



Whenever the front door is opened, the Engine Start/Stop button will illuminate and will go off 30 seconds after the door is closed.

## **!** WARNING

To reduce risk of serious injury or death, NEVER allow children or any person who is unfamiliar with the vehicle to touch the Engine Start/Stop button or related parts. Unexpected and sudden vehicle movement can occur.



## WARNING

To turn the engine off in an emergency:

Press and hold the Engine Start/Stop button for more than two seconds OR Rapidly press and release the Engine Start/Stop button three times (within three seconds).

If the vehicle is still moving, you can restart the engine without depressing the brake pedal by pressing the Engine Start/Stop button with the shift lever in the N (Neutral) position.



## WARNING

- NEVER press the Engine Start/Stop button while the vehicle is in motion except in an emergency. This will result in the engine turning off and loss of power assist for the steering and brake systems.

This may lead to loss of directional control and braking function, which could cause an accident.

- Before leaving the driver's seat, always set the parking brake, press the Engine Start/Stop button to the OFF position, and take the Smart Key with you. Unexpected vehicle movement may occur if these precautions are not followed.
- NEVER reach through the steering wheel for the Engine Start/Stop button or any other control while the vehicle is in motion. The presence of your hand or arm in this area may cause a loss of vehicle control resulting in an accident.

### Engine Stop/Start button positions

Button Position	Action	Notice
OFF	<ul style="list-style-type: none"> <li>To turn off the engine, stop the vehicle and then press the Engine Start/Stop button.</li> <li>The steering wheel locks to protect the vehicle from theft. (if equipped)</li> </ul>	If the steering wheel is not locked properly when you open the driver's door, the warning chime will sound.
ACC	<ul style="list-style-type: none"> <li>Press the Engine Start/Stop button when the button is in the OFF position without depressing the brake pedal.</li> <li>Electrical accessories are usable.</li> <li>The steering wheel unlocks.</li> </ul>	<ul style="list-style-type: none"> <li>If you leave the Engine Start/Stop button in the ACC position for more than one hour, the battery power will turn off automatically to prevent the battery from discharging.</li> <li>If the steering wheel doesn't unlock properly, the Engine Start/Stop button will not work. Press the Engine Start/Stop button while turning the steering wheel right and left to release tension.</li> </ul>
ON	<ul style="list-style-type: none"> <li>Press the Engine Start/Stop button while it is in the ACC position without depressing the clutch pedal.</li> <li>The warning lights can be checked before the engine is started.</li> </ul>	Do not leave the Engine Start/Stop button in the ON position when the engine is not running to prevent the battery from discharging.
START	To start the engine, depress the clutch and brake pedals and press the Engine Start/ Stop button with the shift lever in neutral.	If you press the Engine Start/Stop button without depressing the clutch pedal, the engine does not start and the Engine Start/Stop button changes as follows: <b>OFF → ACC → ON → OFF</b>

### Starting the engine



#### WARNING

- Always wear appropriate shoes when operating your vehicle. Unsuitable shoes, such as high heels, ski boots, sandals, flip-flops, etc., may interfere with your ability to use the brake, accelerator and clutch pedals.
- Do not start the vehicle with the accelerator pedal depressed. The vehicle can move and lead to an accident.
- Wait until the engine RPM is normal. The vehicle may suddenly move if the brake pedal is released when the RPM is high.



#### Information

- The engine will start by pressing the Engine Start/Stop button, only when the smart key is in the vehicle.
- Even if the smart key is in the vehicle, if it is far away from the driver, the engine may not start.
- When the Engine Start/Stop button is in the ACC or ON position, if any door is open, the system checks for the smart key. If the smart key is not in the vehicle, the “” indicator will blink and the warning “Key not in vehicle” will come on, and if all doors are closed, the chime will also sound for about 5 seconds. The indicator will turn off while the vehicle is moving. Keep the smart key in the vehicle when using the ACC position or if the vehicle engine is ON.

Vehicle with Manual Transmission:

1. Always carry the smart key with you.
2. Make sure the parking brake is applied.
3. Make sure the shift lever is in N (Neutral).
4. Depress the clutch and brake pedals.
5. Press the Engine Start/Stop button.

Vehicle with Automated Manual Transmission:

1. Always carry the smart key with you.
2. Make sure the parking brake is applied.
3. Make sure the shift lever is in N (Neutral).
4. Depress the brake pedals.
5. Press the Engine Start/Stop button. The engine can not be started unless the shift lever is ‘N’ position.

## **i** Information

- Do not wait for the engine to warm up while the vehicle remains stationary. Start driving at moderate engine speeds. (Steep accelerating and decelerating should be avoided.)
- Always start the vehicle with your foot on the brake pedal. Do not depress the accelerator while starting the vehicle. Do not race the engine while warming it up.
- When you start to drive, move the shift lever after checking the RPM (revolutions per minute) is in the proper range (under 1,000 RPM) by depressing the clutch pedal and brake pedal.

After releasing the parking brake, take your foot off the clutch and depress the accelerator slowly while starting your vehicle.

## **NOTICE**

To prevent damage to the vehicle:

- If traffic and road conditions permit, you may put the shift lever in the N (Neutral) position while the vehicle is still moving and press the Engine Start/Stop button in an attempt to restart the engine.
- Do not push or tow your vehicle to start the engine.

## **NOTICE**

To prevent damage to the vehicle:

When the stop lamp fuse is blown, you can't start the engine normally. Replace the fuse with a new one. If you are not able to replace the fuse, you can start the engine by pressing and holding the Engine Start/Stop button for 10 seconds with the Engine Start/Stop button in the ACC position.

Do not press the Engine Start/Stop button for more than 10 seconds except when the stop lamp fuse is blown.

For your safety, always depress the brake and/or clutch pedal before starting the engine.

## *Emergency starting*



If the smart key battery is weak or the smart key does not work correctly, you can start the engine by pressing the Engine Start/Stop button with the smart key in the direction of the picture above.

## MANUAL TRANSMISSION (IF EQUIPPED)

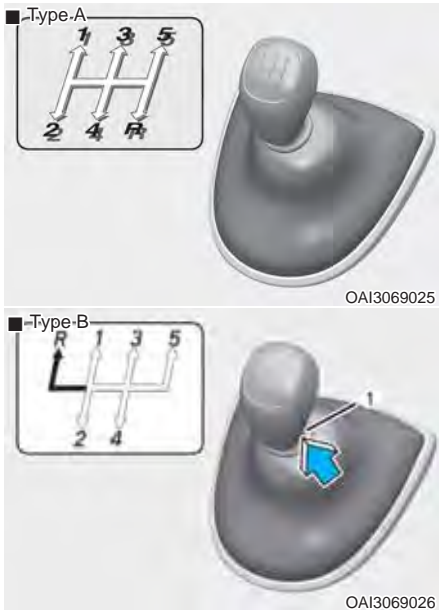

### WARNING

Before leaving the driver's seat, always make sure the shift lever is in the 1st gear when the vehicle is parked on an uphill and in R (Reverse) on a downhill, set the parking brake, and place the ignition switch in the LOCK/OFF position. Unexpected vehicle movement may occur if these precautions are not followed.



To shift to R (Reverse), make sure the vehicle has completely stopped, and then move the shift lever to neutral before moving into R (Reverse).

When you've come to a complete stop and it's hard to shift into the 1st gear or R (Reverse):

1. Put the shift lever in neutral and release the clutch pedal.
2. Depress the clutch pedal, and then shift into the first or R (Reverse) gear.

### Information

**During cold weather, shifting may be difficult until the transmission lubricant has warmed up.**

-  The shift lever can be moved without pressing the button (1).
-  The button (1) must be pressed while moving the shift lever to R (Reverse).

### Manual transmission operation

The manual transmission has 5 forward gears. The transmission is fully synchronized in all forward gears so shifting to either a higher or a lower gear is easily accomplished.



### ***Using the clutch (if equipped)***

The clutch pedal should be depressed all the way to the floor before:

- Starting the engine  
The engine will not start without depressing the clutch pedal.
- Shifting  
To start your vehicle, slowly release the clutch pedal and depress the accelerator.

When releasing the clutch pedal, release it slowly. The clutch pedal should always be released while driving.

#### **NOTICE**

To prevent unnecessary wear or damage to the clutch:

- Do not rest your foot on the clutch pedal while driving.
- Do not hold the vehicle with the clutch on an incline, while waiting for the traffic light, etc.
- Always depress the clutch pedal down fully to prevent noise or damage.
- Do not start with the 2nd (second) gear engaged except when you start on a slippery road.
- Depress the clutch pedal all the way and be careful not to depress the pedal again before returning to the upright position after you release the pedal. If you depress the pedal before returning to the original position repeatedly, it may cause the clutch system failure.

### ***Downshifting***

Downshift when you must slow down in heavy traffic or drive up a steep hill to prevent engine load.

Also, downshifting reduces the chance of stalling and can accelerate when you need to increase your speed again.

When the vehicle is going downhill, downshifting helps maintain safe speed by providing brake power from the engine and enables less wear on the brakes.

#### **NOTICE**

To prevent damage to the engine, clutch and transmission:

- When downshifting from the 5th gear to the 4th gear, be careful not to inadvertently push the shift lever sideways engaging the 2nd gear. A drastic downshift may cause the engine speed to increase to the point the tachometer will enter the red-zone.
- Do not downshift more than two gears at a time or downshift the gear when the engine is running at high speed (5,000 RPM or higher). Such a downshifting may damage the engine, clutch and the transmission.

### Good driving practices

- Never take the vehicle out of gear and coast down a hill. This is extremely dangerous.
- Don't "ride" the brakes. This can cause the brakes and related parts to overheat and malfunction.  
When you are driving down a long hill, slow down and shift to a lower gear. Engine braking will help slow down the vehicle.
- Slow down before shifting to a lower gear. This will help avoid over-revving the engine, which can cause damage.
- Slow down when you encounter cross winds. This gives you much better control of your vehicle.
- Be sure the vehicle is completely stopped before you shift into R (Reverse) to prevent damage to the transmission.
- Exercise extreme caution when driving on a slippery surface. Be especially careful when braking, accelerating or shifting gears. On a slippery surface, an abrupt change in vehicle speed can cause the drive wheels to lose traction and may cause loss of vehicle control resulting in an accident.



### WARNING

**Do not use the engine brake (shifting from a higher gear to lower gear) rapidly on slippery roads. The vehicle may slip causing an accident.**



### WARNING

**To reduce the risk of SERIOUS INJURY or DEATH:**

- **ALWAYS** wear your seatbelt. In a collision, an unbelted occupant is significantly more likely to be seriously injured or killed than a properly belted occupant.
- **Avoid high speeds when cornering or turning.**
- **Do not make quick steering wheel movements, such as sharp lane changes or fast and sharp turns.**
- **The risk of rollover is greatly increased if you lose control of your vehicle at highway speeds.**
- **Loss of control often occurs if two or more wheels drop off the roadway and the driver over steers to reenter the roadway.**
- **In the event your vehicle leaves the roadway, do not steer sharply. Instead, slow down before pulling back into the travel lanes.**
- **HYUNDAI recommends you follow all posted speed limits.**

## AUTOMATED MANUAL TRANSMISSION (AMT) (IF EQUIPPED)

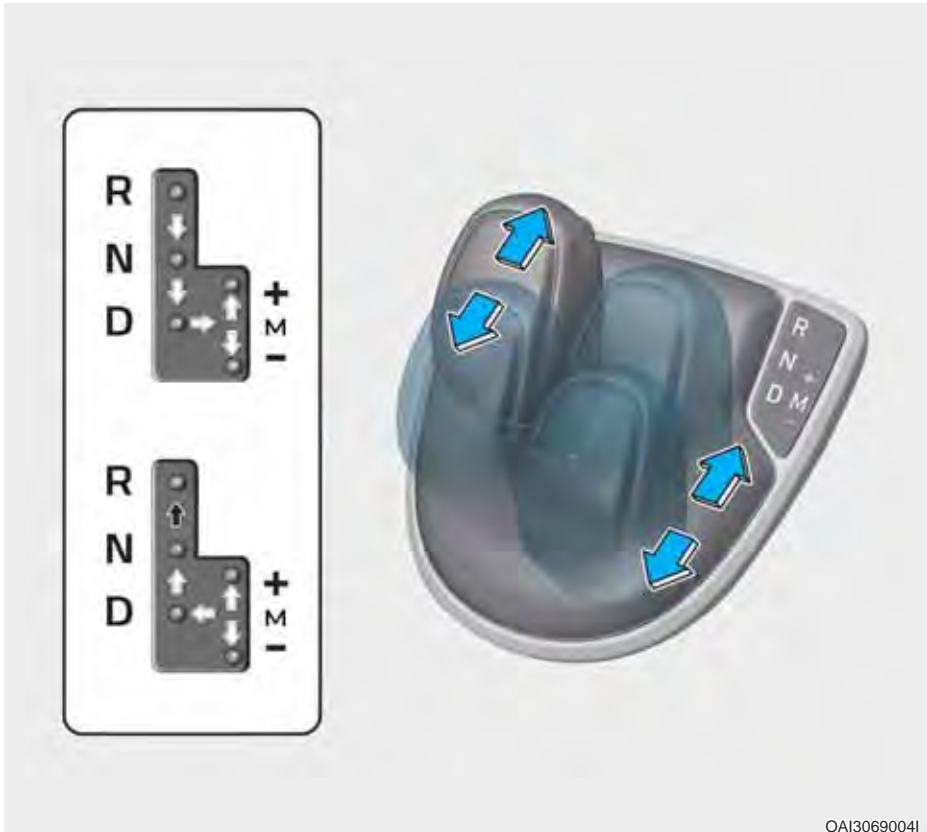

OAI3069004I

 Press the shift button, then move shift lever.

 Move shift lever.

The Automated Manual Transmission (AMT) is a transmission equipped with a gear actuator and a clutch actuator in addition to the conventional manual transmission. To improve the driving convenience, gear shift is automatically performed by the transmission control unit and clutch/gear actuator.

### Automated Manual Transmission (AMT) operation

The Automated Manual Transmission (AMT) has five forward speeds and one reverse speed.

The individual speeds are selected automatically in the D (Drive) position.

### Features of the Automated Manual Transmission (AMT)

- The Automated Manual Transmission (AMT) can be thought of as an automatically shifting manual transmission. It gives the driving feel of a manual transmission.
- When D (Drive) is selected, the transmission will automatically shift through the gears similar to a conventional automatic transmission. Unlike a traditional automatic transmission, the gear shifting can sometimes be felt and heard as the actuators engage the clutches and the gears are selected. When the gear is shifting, you may sometimes hear operating noise. This is normal and does not indicate a problem with your transmission.
- The Automated Manual Transmission (AMT) adopts a dry-type single clutch, which is different from the torque converter of the automatic transmission. It shows better acceleration performance and increased fuel efficiency while driving but initial launch might be little bit slower than the automatic transmission.
- As a result, gear shifts are sometimes more noticeable than a conventional automatic transmission and a light vibration during launching can be felt as the transmission speed is matched with the engine speed. This is a normal condition of the Automated Manual Transmission (AMT).
- The dry-type clutch transfers torque more directly and provides a direct drive feeling which may feel different from a conventional automatic transmission with a torque converter. This may be more noticeable when launching the vehicle from a stop or when traveling at low, stop-and-go vehicle speeds.
- When rapidly accelerating at a low vehicle speed, the engine RPM may increase highly depending on the vehicle's driving condition.
- For a smooth launch uphill, depress the accelerator pedal smoothly depending on the current conditions.
- If you release your foot from the accelerator pedal at low vehicle speed, you may feel engine braking, which is similar to manual transmission.

- When you turn the engine on and off, you may hear clicking sounds as the system goes through a self-test. This is a normal sound for the Automated Manual Transmission (AMT).
- During the first 1,500 km (1,000 miles), you may feel that the vehicle may not be smooth when accelerating at low speed. During this break-in period, the shift quality and performance of your new vehicle is continuously optimized.

### **i** Information - Creeping function

**The Creeping function helps the vehicle to start smoothly. If you take your foot off the brake pedal when the shift lever is either in R (Reverse), D (Drive) or M (Manual) position, the vehicle will start slowly without depressing the accelerator pedal. To disable the function, depress the brake pedal or pull up the parking brake lever.**

**The creeping function will not operate when:**

- **The parking brake lever is engaged with the shift lever in R (Reverse), D (Drive) or M (Manual) position**

### **Automated Manual Transmission (AMT) instruction label**

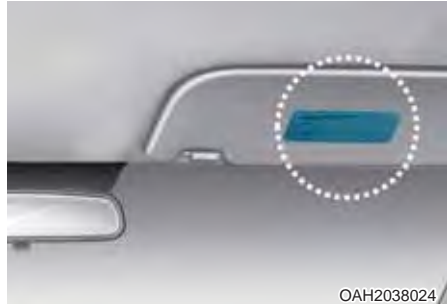

OAH2038024

Read and follow the instruction label attached on the driver side's sunvisor before driving the vehicle.

Lever shifting condition

Lever shifting		Shifting condition		When shifting condition is dissatisfied			
From (Current position)	To (Desired position)	Vehicle speed	Brake	Shift indicator	Sound	Brake press indicator 	Transmission position
R	N	N/A		-	-	-	-
	D	Reversing below 7 km/h (4 mile/h)	Applied	R or N blinking	On	On	N
N	R	Moving forward below 2 km/h (1 mile/h)	Applied	N blinking	On	On	N
	D	Reversing below 7 km/h (4 mile/h)	Applied	N blinking	On	On	N
D	R	Moving forward below 2 km/h (1 mile/h)	Applied	D or N blinking	On	On	N
	N	N/A		-	-	-	-

 **WARNING**

To reduce the risk of serious injury or death:

- ALWAYS check the surrounding areas near your vehicle for people, especially children, before shifting a vehicle into D (Drive) or R (Reverse).
- Before leaving the driver's seat, always make sure the shift lever is in the N (Neutral) position, then set the parking brake, and place the ignition switch in the LOCK/OFF position. Unexpected and sudden vehicle movement can occur if these precautions are not followed.
- Do not use engine braking (shifting from a high gear to lower gear) rapidly on slippery roads. The vehicle may slip causing an accident.

The indicator in the instrument cluster displays the shift lever position when the ignition switch is in the ON position.

 **WARNING**

- After the vehicle has stopped, always make sure the shift lever is in N (Neutral), apply the parking brake, and turn the engine off.
- Do not use the N (Neutral) position in place of the parking brake.

*Automated Manual Transmission (AMT) warning indicator*



**Press Brake**

The engine can not be started unless the shift lever is 'N' position and brake pedal is depressed.

*Automated Manual Transmission (AMT) warning lamp*



**Clutch Over Heated**

This warning light indicates that the clutch is overheat. It appears for a while when the ignition switch is turned ON. The indicator light illuminates when the Clutch's estimated temperature rises up to limited value.

**i** Information

**The AMT warning lamp may come on when clutch slip occurs excessively due to repeated stop-and-go driving on steep grades and when Hill Hold is maintained for a long time. In order to prevent warning lamp ON, use the brake during low speed driving on hill or when stopping the vehicle on an Uphill slope.**

- If the vehicle is held on a hill by using only the accelerator pedal or by creeping with brake pedal disengaged, the clutch may overheat which can result in damage. At this time, a warning lamp will appear on the cluster.
- If the warning lamp is active, the foot brake must be applied.
- Ignoring the warnings can lead to damage to the clutch and transmission.

**Clutch High temperature**

**First warning**

- Under certain conditions, such as repeated stop-and-go launches on steep grades, sudden take off or acceleration, or other harsh driving conditions, the clutch temperature will increase excessively.
- When the clutch temperature is high, the safe protection mode and warning lamp engages and the gear position indicator on the cluster blinks three times with a chime.

**Second warning**

- After first warning, clutch temperature is increased continuously, then warning sound and shift indicator blinks continuously.
- If this occurs, pull over to a safe location, stop the vehicle with the engine running, apply the brakes and allow the clutch to cool for a few minutes with engine on.
- If you ignore this warning, the driving condition may become worse. You may experience abrupt shifts, jerkiness.

To return to the normal driving condition, stop the vehicle and apply the foot brake. Then allow the transmission to cool for a few minutes with engine on.

 **WARNING**

**On an uphill road, never hold the vehicle at a stop using only the accelerator pedal or the creeping mode.**

**This may cause clutch overheating and excessive damage, resulting in the reduction of the clutch's life cycle.**



### *Clutch overheated*

#### **Final warning**

- If the vehicle continues to be driven and the clutch temperatures reach the maximum temperature limit, the warning lamp will be blinked continuously.
- If this occurs, pull over to a safe location, stop the vehicle with the engine running, apply the brakes and allow the clutch to cool for a few minutes with engine on until the warning lamp disappear on the cluster.
- When possible, drive the vehicle smoothly.
- If any of the warnings continue to blink, for your safety, we recommend you contact an authorized HYUNDAI dealer and have the system checked.

### *R (Reverse)*

Use this position to drive the vehicle backward.

#### **NOTICE**

- **Always come to a complete stop before shifting into R (Reverse) position.**
- **When moving to R (Reverse) position the gear is not shifted if the vehicle speed is over 3 km/h.**
- **Depress the brake pedal fully. If not, the brake press indicator will illuminate and the gear is not shifted.**

### *N (Neutral)*

The wheels and transmission are not engaged.

Use N (Neutral) if you need to restart a stalled engine, or if it is necessary to stop with the engine ON.

Always depress the brake pedal when you are shifting from N (Neutral) to another gear.



#### **WARNING**

**Do not shift into gear unless your foot is firmly on the brake pedal. Shifting into gear when the engine is running at high speed can cause the vehicle to move very rapidly. You could lose control of the vehicle and hit people or objects.**

### *D (Drive)*

This is the normal forward driving position. The transmission will automatically shift to the appropriate gear position upon operation of the accelerator pedal and variation of vehicle speed.

For extra power when passing another vehicle or driving uphill, depress the accelerator further until you feel the transmission downshift to a lower gear.

### When starting off on an uphill

- Engage the parking brake firmly to prevent the vehicle from rolling backwards.
- Move the shift lever to D (Drive) position while depressing the brake pedal. Make sure that the shift indicator in the cluster displays 1st gear.
- Take your foot off the brake pedal and depress the accelerator pedal gradually. Then, when the vehicle starts moving, release the parking brake and depress the accelerator pedal.

### When starting off on a downhill

- Depress the brake pedal and move the shift lever to D (Drive) position. Make sure that the shift indicator in the cluster displays 1st gear.
- Take your foot off the brake pedal and slowly depress the accelerator pedal. When the vehicle speed increases, the clutch will be engaged.

### NOTICE

- If the gear is not shifted after changing the shift lever from N (Neutral) to D (Drive)/M (Manual)/R (Reverse), try to shift the gear again. In this case, time delay and intermittent noise may occur which are normal.
- Always come to a complete stop and depress the brake pedal before shifting into D (Drive) position .
- When moving from R (Reverse) to D (Drive) position, the gear is not shifted if the vehicle speed is over 8 km/h (5 mph).
- Depress the brake pedal fully. If not, the brake press indicator will illuminate and the gear is not shifted.

## Manual shift mode



OAI3069005I

Whether the vehicle is stationary or in motion, Manual shift mode is selected by pushing the shift lever from the D (Drive) position into the manual gate (M). To return to D (Drive) range operation, push the shift lever back into the main gate.

In Manual shift mode, moving the shift lever backwards and forwards will allow you to select the desired range of gears for the current driving conditions.

- + (Up) : Push the lever forward once to shift up one gear.
- (Down) : Pull the lever backwards once to shift down one gear.

### NOTICE

If you cannot move the shift lever into any position or if the gear is automatically moved to N (Neutral) position when the vehicle speed becomes below 10 km/h, this may indicate malfunction of the system. In this case, we recommend the system be checked by an authorized HYUNDAI dealer.

### **i** Information

- Only the five forward gears can be selected. To reverse or park the vehicle, move the shift lever to the R (Reverse) or N (Neutral) position as required.
- Downshifts are made automatically when the vehicle slows down. When the vehicle stops, 1st gear is automatically selected.
- When the engine rpm approaches the red zone the transmission will upshift automatically.
- If the driver presses the lever to + (Up) or - (Down) position, the transmission may not make the requested gear change if the next gear is outside of the allowable engine RPM range. The driver must execute upshifts in accordance with road conditions, taking care to keep the engine RPMs below the red zone.
- When accelerating from a stop on a slippery road, push the shift lever forward into the + (Up) position. This allows the transmission to shift into the 2nd gear which is better for smooth driving on a slippery road. Push the shift lever to the - (Down) side to shift back to the 1st gear.

### Parking

To park your vehicle, always come to a complete stop and continue to depress the brake pedal.

- When parking on the flat road, move the shift lever from D (Drive)/R (Reverse) to N (Neutral) position. Then, engage the parking brake firmly before turning off the engine.
- When parking on a slope, it is recommended to place the shift lever in D (Drive) for uphill and R (Reverse) for downhill and to engage the parking brake before turning off the engine.

If the engine was turned off with the shift lever in D (Drive) or R (Reverse) position, it is necessary to depress the brake pedal and move the shift lever to N (Neutral) position to turn on the engine. Take the Key with you when exiting the vehicle.



### WARNING

**When you stay in the vehicle with the engine running, be careful not to depress the accelerator pedal for a long period of time. The engine or exhaust system may overheat and start a fire.**

**The exhaust gas and the exhaust system are very hot. Keep away from the exhaust system components.**

**Do not stop or park over flammable materials, such as dry grass, paper or leaves. They may ignite and cause a fire.**

### Good driving practices

- Never move the shift lever from N (Neutral) to any other position with the accelerator pedal depressed.
- Be sure the vehicle is completely stopped before you attempt to shift into R (Reverse) or D (Drive).
- Do not move the shift lever to N (Neutral) when driving. Doing so may result in an accident because of a loss of engine braking and the transmission could be damaged.
- Driving uphill or downhill, always shift to D (Drive) when driving forward or to R (Reverse) when driving backwards, and check the gear position indicated on the cluster before driving. If you drive in the opposite direction of the selected gear, the engine will turn off and a serious accident might be occurred due to the degraded brake performance.
- Do not drive with your foot resting on the brake pedal. Even light, but consistent pedal pressure can result in the brakes overheating, brake wear and possibly even brake failure.
- Depressing both accelerator and brake pedals at the same time can trigger logic for engine power reduction to assure vehicle deceleration. Vehicle acceleration will resume after the brake pedal is released.
- When driving in Manual shift mode, slow down before shifting to a lower gear. Otherwise, the lower gear may not be engaged if the engine RPMs are outside of the allowable range.

- Always apply the parking brake when leaving the vehicle. Do not depend on placing the transmission in N (Neutral) to keep the vehicle from moving.
- Exercise extreme caution when driving on a slippery surface. Be especially careful when braking, accelerating or shifting gears. On a slippery surface, an abrupt change in vehicle speed can cause the drive wheels to lose traction and may cause loss of vehicle control resulting in an accident
- Optimum vehicle performance and economy is obtained by smoothly depressing and releasing the accelerator.



## WARNING

To reduce the risk of **SERIOUS INJURY** or **DEATH**:

- **ALWAYS** wear your seatbelt. In a collision, an unbelted occupant is significantly more likely to be seriously injured or killed than a properly belted occupant.
- **Avoid high speeds when cornering or turning.**
- **Do not make quick steering wheel movements, such as sharp lane changes or fast, sharp turns.**
- **The risk of rollover is greatly increased if you lose control of your vehicle at highway speeds.**
- **Loss of control often occurs if two or more wheels drop off the roadway and the driver over steers to reenter the roadway.**
- **In the event your vehicle leaves the roadway, do not steer sharply. Instead, slow down before pulling back into the travel lanes.**
- **HYUNDAI recommends you follow all posted speed limits.**

## BRAKING SYSTEM

### Power brakes

Your vehicle has power-assisted brakes that adjust automatically through normal usage.

If the engine is not running or is turned off while driving, the power assist for the brakes will not work. You can still stop your vehicle by applying greater force to the brake pedal than typical. The stopping distance, however, will be longer than with power brakes.

Pump the brake pedal only when necessary to maintain steering control on slippery surfaces.

### Information

- **When the brake pedal is depressed under certain driving conditions or weather conditions, you may temporarily hear a noise. This is normal and does not indicate a problem with your brakes.**
- **If deicing chemicals get stuck on the brakes, abnormal wear and noise may occur on the brake discs and pads. Remove the deicing chemicals from the brake discs and pads while applying the brakes in a safe traffic condition.**

### WARNING

Take the following precautions:

- Do not drive with your foot resting on the brake pedal. This will create abnormal high brake temperatures, excessive brake lining and pad wear, and increased stopping distances.

- When descending a long or steep hill, shift to a lower gear and avoid continuous application of the brakes. Applying the brakes continuously will cause the brakes to overheat and could result in a temporary loss of braking performance.
- Wet brakes may impair the vehicle's ability to safely slow down; the vehicle may also pull to one side when the brakes are applied. Applying the brakes lightly will indicate whether they have been affected in this way. Always test your brakes in this fashion after driving through deep water. To dry the brakes, lightly tap the brake pedal to heat up the brakes while maintaining a safe forward speed until brake performance returns to normal. Avoid driving at high speeds until the brakes function correctly.

### Disc brakes wear indicator

When your brake pads are worn and new pads are required, you will hear a high pitched warning sound from your front or rear brakes. You may hear this sound come and go or it may occur whenever you depress the brake pedal.

### **NOTICE**

To avoid costly brake repairs, do not continue to drive with worn brake pads.

### Information

Always replace brake pads as complete front or rear axle sets.

## Rear drum brakes

Your rear drum brakes do not have wear indicators. Therefore, have the rear brake linings inspected if you hear a rear brake rubbing noise. Also have your rear brakes inspected each time you change or rotate your tires and when you have the front brakes replaced.

## Parking brake



Always set the parking brake before leaving the vehicle, to apply:  
Firmly depress the brake pedal.  
Pull up the parking brake lever as far as possible.

### WARNING

To reduce the risk of **SERIOUS INJURY** or **DEATH**, do not operate the parking brake while the vehicle is moving except in an emergency situation. It could damage the brake system and lead to an accident.



To release:

Firmly depress the brake pedal.  
Slightly pull up the parking brake lever.  
While pressing the release button (1), lower the parking brake (2).

If the parking brake does not release or does not release all the way, we recommend that the system be checked by an authorized HYUNDAI dealer.

### WARNING

- Whenever leaving the vehicle or parking, always come to a complete stop and continue to depress the brake pedal. Move the shift lever into the 1st gear (for manual transmission vehicle) or N (Neutral) position (for Automated Manual Transmission vehicle), then apply the parking brake, and place the ignition switch in the LOCK/OFF position.

Vehicles with the parking brake not fully engaged are at risk for moving inadvertently and causing injury to yourself or others.

- NEVER allow anyone who is unfamiliar with the vehicle to touch the parking brake. If the parking brake is released unintentionally, serious injury may occur.
- Only release the parking brake when you are seated inside the vehicle with your foot firmly on the brake pedal.

### **NOTICE**

- Do not apply the accelerator pedal while the parking brake is engaged. If you depress the accelerator pedal with the parking brake engaged, it will make warning sounds. Damage to the parking brake may occur.
- Driving with the parking brake on can overheat the braking system and cause premature wear or damage to brake parts. Make sure the parking brake is released and the Brake Warning Light is off before driving.

### ***Parking brake warning light***



Check the Parking Brake Warning Light by placing the ignition switch to the ON position (do not start the engine).

This light will be illuminated when the parking brake is applied with the ignition switch in the START or ON position.

Before driving, be sure the parking brake is released and the Brake Warning Light is OFF.

If the Parking Brake Warning Light remains on after the parking brake is released while the engine is running, there may be a malfunction in the brake system. Immediate attention is necessary.

If at all possible, cease driving the vehicle immediately. If that is not possible, use extreme caution while operating the vehicle and only continue to drive the vehicle until you can reach a safe location.



## Anti-lock Brake System (ABS)



### WARNING

An Anti-Lock Braking System (ABS) or an Electronic Stability Control (ESC) system will not prevent accidents due to improper or dangerous driving maneuvers. Even though vehicle control is improved during emergency braking, always maintain a safe distance between you and objects ahead of you. Vehicle speeds should always be reduced during extreme road conditions. The braking distance for vehicles equipped with ABS or ESC may be longer than for those without these systems in the following road conditions.

Drive your vehicle at reduced speeds during the following conditions:

- Rough, gravel or snow-covered roads.
- On roads where the road surface is pitted or has different surface height.
- Tire chains are installed on your vehicle.

The safety features of an ABS or ESC equipped vehicle should not be tested by high speed driving or cornering. This could endanger the safety of yourself or others.

ABS is an electronic braking system that helps prevent a braking skid. ABS allows the driver to steer and brake at the same time.

## Using ABS

To obtain the maximum benefit from your ABS in an emergency situation, do not attempt to modulate your brake pressure and do not try to pump your brakes. Depress your brake pedal as hard as possible.

When you apply your brakes under conditions which may lock the wheels, you may hear sounds from the brakes, or feel a corresponding sensation in the brake pedal. This is normal and it means your ABS is active.

ABS does not reduce the time or distance it takes to stop the vehicle.

Always maintain a safe distance from the vehicle in front of you.

ABS will not prevent a skid that results from sudden changes in direction, such as trying to take a corner too fast or making a sudden lane change. Always drive at a safe speed for the road and weather conditions.

ABS cannot prevent a loss of stability. Always steer moderately when braking hard. Severe or sharp steering wheel movement can still cause your vehicle to veer into oncoming traffic or off the road.

On loose or uneven road surfaces, operation of the anti-lock brake system may result in a longer stopping distance than for vehicles equipped with a conventional brake system.

The ABS warning light (  ) will stay on for several seconds after the ignition switch is in the ON position. During that time, the ABS will go through self-diagnosis and the light will go off if everything is normal. If the light stays on, you may have a problem with your ABS. We recommend that you contact an authorized HYUNDAI dealer as soon as possible.

 **WARNING**

If the ABS warning light () is on and stays on, you may have a problem with the ABS. Your power brakes will work normally. To reduce the risk of serious injury or death, we recommend that you contact your HYUNDAI dealer as soon as possible.

**NOTICE**

When you drive on a road having poor traction, such as an icy road, and apply your brakes continuously, the ABS will be active continuously and the ABS warning light () may illuminate. Pull your vehicle over to a safe place and turn the engine off.

Restart the engine. If the ABS warning light is off, then your ABS system is normal.

Otherwise, you may have a problem with your ABS system. We recommend that you contact an authorized HYUNDAI dealer as soon as possible.

 **Information**

When you jump start your vehicle because of a drained battery, the ABS warning light () may turn on at the same time. This happens because of the low battery voltage. It does not mean your ABS is malfunctioning. Have the battery recharged before driving the vehicle.

**Electronic Stability Control (ESC) (if equipped)**



The Electronic Stability Control (ESC) system helps to stabilize the vehicle during cornering maneuvers.

ESC checks where you are steering and where the vehicle is actually going.

ESC applies braking pressure to any one of the vehicle's brakes and intervenes in the engine management system to assist the driver with keeping the vehicle on the intended path. It is not a substitute for safe driving practices. Always adjust your speed and driving to the road conditions.

 **WARNING**

Never drive too fast for the road conditions or too quickly when cornering. The ESC system will not prevent accidents.

Excessive speed in turns, abrupt maneuvers, and hydroplaning on wet surfaces can result in severe accidents.

## ESC operation

### ESC ON condition

When the ignition switch is in the ON position, the ESC and the ESC OFF indicator lights illuminate for approximately three seconds and goes off, then the ESC is turned on.

### When operating



When the ESC is in operation, the ESC indicator light blinks:

- When you apply your brakes under conditions which may lock the wheels, you may hear sounds from the brakes, or feel a corresponding sensation in the brake pedal. This is normal and it means your ESC is active.
- When the ESC activates, the engine may not respond to the accelerator as it does under routine conditions.
- If the Cruise Control was in use when the ESC activates, it automatically disengages. The Cruise Control can be reengaged when the road conditions allow. **See "Cruise Control" in this chapter 7** (if equipped).
- When moving out of the mud or driving on a slippery road, the engine RPM (revolutions per minute) may not increase even if you press the accelerator pedal deeply. This is to maintain the stability and traction of the vehicle and does not indicate a problem.

### ESC OFF condition



To cancel ESC operation :

- State 1

Press the ESC OFF button briefly. The ESC OFF indicator light and/or message "Traction control disabled" will illuminate and a warning chime will sound. In this state, the traction control function of ESC (engine management) is disabled, but the brake control function of ESC (braking management) still operates.

- State 2

Press and hold the ESC OFF button continuously for more than 3 seconds. The ESC OFF indicator light and/or message "Traction control and ESC disabled" illuminates and a warning chime sounds. In this state, both the traction control function of ESC (engine management) and the brake control function of ESC (braking management) are disabled.

If the ignition switch is placed in the LOCK/OFF position when the ESC is off, the ESC remains off. Upon restarting the vehicle, the ESC will automatically turn on again.

### Indicator lights

- ESC indicator light (blinks)



OTD059012

- ESC OFF indicator light (comes on)



OTD059013

When the ignition switch is in the ON position, the ESC indicator light illuminates, then goes off if the ESC system is operating normally.

The ESC indicator light blinks whenever the ESC is operating.

If the ESC indicator light stays on, your vehicle may have a malfunction with the ESC system. When this warning light illuminates, we recommend that the vehicle be checked by an authorized HYUNDAI dealer as soon as possible.

The ESC OFF indicator light comes on when the ESC is turned off with the button.

### WARNING

When the ESC is blinking, this indicates the ESC is active:

Drive slowly and **NEVER** attempt to accelerate. **NEVER** turn the ESC off while the ESC indicator light is blinking or you may lose control of the vehicle resulting in an accident.

### NOTICE

Driving with wheels and tires with different sizes may cause the ESC system to malfunction. Before replacing tires, make sure all four tires and wheels are the same size. Never drive the vehicle with different sized wheels and tires installed.

## ESC OFF usage

### When Driving

The ESC OFF mode should only be used briefly to help free the vehicle if stuck in snow or mud, by temporarily stopping operation of the ESC, to maintain wheel torque.

To turn the ESC off while driving, press the ESC OFF button while driving on a flat road surface.

### NOTICE

To prevent damage to the transmission:

- Do not allow wheel(s) of one axle to spin excessively while the ESC, ABS, and parking brake warning lights are displayed. The repairs would not be covered by the vehicle warranty. Reduce engine power and do not spin the wheel(s) excessively while these lights are displayed.
- When operating the vehicle on a dynamometer, make sure the ESC is turned off (ESC OFF light illuminated).

### Information

Turning the ESC off does not affect ABS or standard brake system operation.

## Vehicle Stability Management (VSM) (if equipped)

The Vehicle Stability Management (VSM) is a function of the Electronic Stability Control (ESC) system. It helps ensure the vehicle stays stable when accelerating or braking suddenly on wet, slippery and rough roads where traction over the four tires can suddenly become uneven.



### WARNING

Take the following precautions when using the Vehicle Stability Management (VSM):

- ALWAYS check the speed and the distance to the vehicle ahead. The VSM is not a substitute for safe driving practices.
- Never drive too fast for the road conditions. The VSM system will not prevent accidents. Excessive speed in bad weather, slippery and uneven roads can result in severe accidents.

### VSM operation

#### VSM ON condition

The VSM operates when:

- The Electronic Stability Control (ESC) is on.
- Vehicle speed is approximately above 15 km/h (9 mph) on curve roads.
- Vehicle speed is approximately above 20 km/h (12 mph) when the vehicle is braking on rough roads.

#### When operating



When you apply your brakes under conditions which may activate the ESC, you may hear sounds from the brakes, or feel a corresponding sensation in the brake pedal. This is normal and it means your VSM is active.

### Information

The VSM does not operate when:

- **Driving on a banked road such as gradient or incline**
- **Driving in reverse.**
- **The ESC OFF indicator light is on.**
- **The MDPS (Motor Driven Power Steering) (  ) is on or blinks.**

### WARNING

If the ESC indicator light (  ) or the MDPS warning light (  ) stays on or blinks, your vehicle may have a malfunction with the VSM system. When the warning light illuminates we recommend that the vehicle be checked by an authorized HYUNDAI dealer as soon as possible.

### NOTICE

Driving with wheels and tires with different sizes may cause the ESC system to malfunction. Before replacing tires, make sure all four tires and wheels are the same size. Never drive the vehicle with different sized tires and wheels installed.

### Hill-Start Assist Control (HAC) (if equipped)

Hill-Start Assist Control helps prevent the vehicle from rolling backwards when starting a vehicle from a stop on a hill. The system operates the brakes automatically for approximately 2 seconds (maximum of 5 seconds when the accelerator pedal is slightly depressed during HAC operation) and releases the brake after 2 seconds or when the accelerator pedal is depressed.

### WARNING

Always be ready to depress the accelerator pedal when starting off an incline. Hill-Start Assist Control activates only for approximately 2 seconds (maximum of 5 seconds when the accelerator pedal is slightly depressed during HAC operation).

### Information

- **Hill-Start Assist Control does not operate when the gear is shifted to P (Park) or N (Neutral).**
- **Hill-Start Assist Control activates even when the ESC (Electronic Stability Control) is off. However, it does not activate, when ESC does not operate normally.**

## Emergency Stop Signal (ESS)

The Emergency Stop Signal system alerts the driver behind by blinking the stop light when the vehicle is braked rapidly and severely.

The system is activated when:

- The vehicle suddenly stops (vehicle speed is over 55 km/h and the vehicle deceleration at greater than 7 m/s<sup>2</sup>)
- The ABS is activating

When the vehicle speed is under 40 km/h and the ABS deactivates or the sudden stop situation is over, the stop light blinking will stop. Instead, the hazard warning flasher will turn on automatically.

The hazard warning flasher will turn off when the vehicle speed is over 10 km/h (6.2 mph) after the vehicle has stopped. Also, it will turn off when the vehicle is driven at low speed for some time. You can turn it off manually by pushing the hazard warning flasher switch.



### CAUTION

**The Emergency Stop Signal (ESS) system will not work if the hazard warning flasher is already on.**

## Brake Assist System (BAS) (if equipped)

The Brake Assistant System provides additional pressure when the brake pedal is momentarily and strongly depressed in a situation sudden braking is required whilst driving. The Brake Assistant System reduces the time for ABS (Anti-Lock Brake System) control to enter and consequently reduces the braking distance, by providing additional pressure up to the point of ABS intervention.

### *BAS operation*

- When the vehicle speed is more than 30 km/h (20 mph) and the ABS control is not entered.
- When the brake pedal is depressed strongly over a certain level.
- When the friction of the road surface is above a certain level.

### *BAS operation off*

- The vehicle speed is below 10 km/h (6 mph).
- The brake pedal is depressed over a certain conditions.
- The friction of the road surface is below a certain level.



### WARNING

**The system may not operate depending on driver's driving habit, the degree to which the brake pedal is depressed and the road surface condition.**

## Good braking practices



### **WARNING**

Whenever leaving the vehicle or parking, always come to a complete stop and continue to depress the brake pedal. Move the shift lever into the 1st gear (for manual transmission vehicle) or N (Neutral) position (for Automated Manual Transmission vehicle), then apply the parking brake, and place the ignition switch in the LOCK/OFF position.

Vehicles with the parking brake not fully engaged are at risk for moving inadvertently and causing injury to yourself or others.

Wet brakes can be dangerous! The brakes may get wet if the vehicle is driven through standing water or if it is washed. Your vehicle will not stop as quickly if the brakes are wet. Wet brakes may cause the vehicle to pull to one side.

To dry the brakes, apply the brakes lightly until the braking action returns to normal, taking care to keep the vehicle under control at all times. If the braking action does not return to normal, stop as soon as it is safe to do so and we recommend that you call an authorized HYUNDAI dealer for assistance.

DO NOT drive with your foot resting on the brake pedal. Even light, but constant pedal pressure can result in the brakes overheating, brake wear, and possibly even brake failure.

If a tire goes flat while you are driving, apply the brakes gently and keep the vehicle pointed straight ahead while you slow down. When you are moving slowly enough for it to be safe to do so, pull off the road and stop in a safe location.

Keep your foot firmly on the brake pedal when the vehicle is stopped to prevent the vehicle from rolling forward.



## SPECIAL DRIVING CONDITIONS

### Hazardous driving conditions

When hazardous driving conditions are encountered such as water, snow, ice, mud or sand:

Drive cautiously and allow extra distance for braking.

Avoid sudden movements in braking or steering.

If stuck in snow, mud, or sand, use second gear. Accelerate slowly to avoid spinning the drive wheels.



### WARNING

**Downshifting with an Automated manual transmission while driving on slippery surfaces can cause an accident. The sudden change in tire speed could cause the tires to skid. Be careful when downshifting on slippery surfaces.**

Use sand, rock salt, or other non-slip material under the drive wheels to provide traction when stalled in ice, snow, or mud.

### Rocking the vehicle

If it is necessary to rock the vehicle to free it from snow, sand, or mud, first turn the steering wheel to the right and left to clear the area around your front wheels. Then, shift back and forth between the 1st and R (Reverse, for manual transmission vehicle) or R (Reverse) and a forward gear (for Automated manual transmission vehicle). Try to avoid spinning the wheels, and do not race the engine.

To prevent transmission wear, wait until the wheels stop spinning before shifting gears. Release the accelerator pedal while shifting, and press lightly on the accelerator pedal while the transmission is in gear. Slowly spinning the wheels in forward and reverse directions causes a rocking motion that may free the vehicle.

### NOTICE

**If the tires spin at high speed, the tires can explode and you or others may be injured. Do not attempt this procedure if people or objects are anywhere near the vehicle.**

The vehicle can overheat causing an engine compartment fire or other damage. Spin the wheels as little as possible and avoid spinning the wheels at speeds over 56 km/h (35 mph) as indicated on the speedometer.

### NOTICE

**If you are still stuck after rocking the vehicle a few times, have the vehicle pulled out by a tow vehicle to avoid engine overheating, possible damage to the transmission, and tire damage. See "Towing" in chapter 8.**

### Smooth cornering

Avoid braking or gear changing in corners, especially when roads are wet. Ideally, corners should always be taken under gentle acceleration.

### Driving at night

Night driving presents more hazards than driving in the daylight. Here are some important tips to remember:

- Slow down and keep more distance between you and other vehicles, as it may be more difficult to see at night, especially in areas where there may not be any street lights.
- Adjust your mirrors to reduce the glare from other driver's headlights.
- Keep your headlights clean and properly aimed. Dirty or improperly aimed headlights will make it much more difficult to see at night.
- Avoid staring directly at the headlights of oncoming vehicles. You could be temporarily blinded, and it will take several seconds for your eyes to readjust to the darkness.

### Driving in the rain

Rain and wet roads can make driving dangerous. Here are a few things to consider when driving in the rain or on slick pavement:

- Slow down and allow extra following distance. A heavy rainfall makes it harder to see and increases the distance needed to stop your vehicle.
- Replace your windshield wiper blades when they show signs of streaking or missing areas on the windshield.
- Be sure your tires have enough tread. If your tires do not have enough tread, making a quick stop on wet pavement can cause a skid and possibly lead to an accident. See "Tire replacement" in chapter 9.
- Turn on your headlights to make it easier for others to see you.
- Driving too fast through large puddles can affect your brakes. If you must go through puddles, try to drive through them slowly.
- If you believe your brakes may be wet, apply them lightly while driving until normal braking operation returns.

### *Hydroplaning*

If the road is wet enough and you are going fast enough, your vehicle may have little or no contact with the road surface and actually ride on the water. The best advice is **SLOW DOWN** when the road is wet. The risk of hydroplaning increases as the depth of tire tread decreases, refer to "Tire replacement" in chapter 9.

## Driving in flooded areas

Avoid driving through flooded areas unless you are sure the water is no higher than the bottom of the wheel hub. Drive through any water slowly. Allow adequate stopping distance because brake performance may be reduced.

After driving through water, dry the brakes by gently applying them several times while the vehicle is moving slowly.

## WINTER DRIVING

### Snow or icy conditions

You need to keep sufficient distance between your vehicle and the vehicle in front of you.

Apply the brakes gently. Speeding, rapid acceleration, sudden brake applications, and sharp turns are potentially very hazardous practices. During deceleration, use engine braking to the fullest extent. Sudden brake applications on snowy or icy roads may cause skids to occur.

To drive your vehicle in deep snow, it may be necessary to use snow tires or to install tire chains on your tires.

Always carry emergency equipment. Some of the items you may want to carry include tire chains, tow straps or chains, a flashlight, emergency flares, sand, a shovel, jumper cables, a window scraper, gloves, ground cloth, coveralls, a blanket, etc.

### Snow tires



#### WARNING

**Snow tires should be equivalent in size and type to the vehicle's standard tires. Otherwise, the safety and handling of your vehicle may be adversely affected.**

If you mount snow tires on your vehicle, make sure to use radial tires of the same size and load range as the original tires. Mount snow tires on all four wheels to balance your vehicle's handling in all weather conditions. The traction provided by snow tires on dry roads may not be as high as your vehicle's original equipment tires. Check with the tire dealer for maximum speed recommendations.

We recommend you use snow tires when road temperature is below 7 °C (45 °F).

### Information

**Do not install studded tires without first checking local and municipal regulations for possible restrictions against their use.**

### Tire chains



Since the sidewalls of radial tires are thinner than other types of tires, they may be damaged by mounting some types of tire chains on them. Therefore, the use of snow tires is recommended instead of tire chains. Do not mount tire chains on vehicles equipped with aluminum wheels; if possible use a wire type chain. If tire chains must be used, Use wire-type chains with a thickness of less than 15 mm (0.59 in) and install the tire chain after reviewing the instructions provided with the tire chains. Damage to your vehicle caused by improper tire chain use is not covered by your vehicle manufacturer's warranty.



## WARNING

The use of tire chains may adversely affect vehicle handling:

- Drive less than 30 km/h (20 mph) or the chain manufacturer's recommended speed limit, whichever is lower.
- Drive carefully and avoid bumps, holes, sharp turns, and other road hazards, which may cause the vehicle to bounce.
- Avoid sharp turns or locked wheel braking.



## Information

- **Install tire chains on the front tires.** It should be noted that installing tire chains on the tires will provide a greater driving force, but will not prevent side skids.
- **Do not install tire chains without first checking local and municipal regulations for possible restrictions against their use.**

## Chain Installation

When installing tire chains, follow the manufacturer's instructions and mount them as tightly possible. Drive slowly (less than 30 km/h (20 mph)) with chains installed. If you hear the chains contacting the body or chassis, stop and tighten them. If they still make contact, slow down until the noise stops. Remove the tire chains as soon as you begin driving on cleared roads.

When mounting snow chains, park the vehicle on level ground away from traffic. Turn on the vehicle Hazard Warning Flasher and place a triangular emergency warning device behind the vehicle (if available). Always place the vehicle in N (Neutral), apply the parking brake and turn off the engine before installing snow chains.

## NOTICE

When using tire chains:

- Wrong size chains or improperly installed chains can damage your vehicle's brake lines, suspension, body and wheels.
- Use SAE "S" class or wire chains.
- If you hear noise caused by chains contacting the body, retighten the chain to prevent contact with the vehicle body.
- To prevent body damage, retighten the chains after driving 0.5-1.0 km (0.3-0.6 miles).
- Do not use tire chains on vehicles equipped with aluminum wheels. If unavoidable, use a wire type chain.
- Use wire chains less than 15 mm (0.59 in) wide to prevent damage to the chain's connection.

## Winter precautions

### ***Use high quality ethylene glycol coolant***

Your vehicle is delivered with high quality ethylene glycol coolant in the cooling system. It is the only type of coolant that should be used because it helps prevent corrosion in the cooling system, lubricates the water pump and prevents freezing. Be sure to replace or replenish your coolant in accordance with the maintenance schedule in chapter 9. Before winter, have your coolant tested to assure that its freezing point is sufficient for the temperatures anticipated during the winter.

### ***Check battery and cables***

Winter puts additional burdens on the battery system. Visually inspect the battery and cables as described in chapter 8. The level of charge in your battery can be checked by an authorized HYUNDAI dealer or a service station.

### ***Change to “winter weight” oil if necessary***

In some climates, it is recommended that a lower viscosity “winter weight” oil be used during cold weather. See chapter 2 for recommendations. If you aren’t sure what weight oil you should use, we recommend that you consult with an authorized HYUNDAI dealer.

### ***Check spark plugs and ignition system***

Inspect your spark plugs as described in chapter 9 and replace them if necessary. Also check all ignition wiring and components to be sure they are not cracked, worn or damaged in any way.

### ***To keep locks from freezing***

To keep the locks from freezing, squirt an approved de-icer fluid or glycerine into the key opening. If a lock is covered with ice, squirt it with an approved de-icing fluid to remove the ice. If the lock is frozen internally, you may be able to thaw it out by using a heated key. Handle the heated key with care to avoid injury.

### ***Use approved window washer anti-freeze in system***

To keep the water in the window washer system from freezing, add an approved window washer anti-freeze solution in accordance with instructions on the container. Window washer anti-freeze is available from an authorized HYUNDAI dealer and most auto parts outlets. Do not use engine coolant or other types of anti-freeze as these may damage the paint finish.

***Don't let your parking brake freeze***

Under some conditions, your parking brake can freeze in the engaged position. This is most likely to happen when there is an accumulation of snow or ice around or near the rear brakes or if the brakes are wet. If there is a risk the parking brake may freeze, apply it only temporarily while you put the shift lever in N (for Automated Manual Transmission) or in the first or reverse gear (for Manual Transmission) and block the rear wheels so the vehicle cannot roll. Then release the parking brake.

***Don't let ice and snow accumulate underneath***

Under some conditions, snow and ice can build up under the fenders and interfere with the steering. When driving in severe winter conditions where this may happen, you should periodically check underneath the car to be sure the movement of the front wheels and the steering components is not obstructed.

***Carry emergency equipment***

Depending on the severity of the weather, you should carry appropriate emergency equipment. Some of the items you may want to carry include tire chains, tow straps or chains, flashlight, emergency flares, sand, shovel, jumper cables, window scraper, gloves, ground cloth, coveralls, blanket, etc.

***Don't place foreign objects or materials in the engine compartment***

Placement of foreign objects or materials which prevent cooling of the engine, in the engine compartment, may cause a failure or combustion. The manufacturer is not responsible for the damage caused by such placement.

***Drive your vehicle when water vapor condenses and accumulates inside the exhaust pipes***

When the vehicle is stopped for a long time in winter while the engine is running, water vapor may condense and accumulate inside the exhaust pipes. Water in the exhaust pipes may cause noise, etc., but it is drained driving at medium to high speed.

## VEHICLE WEIGHT

Two labels on your driver's door sill show how much weight your vehicle was designed to carry: the Tire and Loading Information Label and the Certification Label.

Before loading your vehicle, familiarize yourself with the following terms for determining your vehicle's weight ratings, from the vehicle's specifications and the Certification Label:

### Base Curb Weight

This is the weight of the vehicle including a full tank of fuel and all standard equipment. It does not include passengers, cargo, or optional equipment.

### Vehicle Curb Weight

This is the weight of your new vehicle when you picked it up from your dealer plus any aftermarket equipment.

### Cargo Weight

This figure includes all weight added to the Base Curb Weight, including cargo and optional equipment.

### GAW (Gross Axle Weight)

This is the total weight placed on each axle (front and rear) - including vehicle curb weight and all payload.

### GAWR (Gross Axle Weight Rating)

This is the maximum allowable weight that can be carried by a single axle (front or rear). These numbers are shown on the Certification Label. The total load on each axle must never exceed its GAWR.

### GVW (Gross Vehicle Weight)

This is the Base Curb Weight plus actual Cargo Weight plus passengers.

### GVWR (Gross Vehicle Weight Rating)

This is the maximum allowable weight of the fully loaded vehicle (including all options, equipment, passengers and cargo). The GVWR is shown on the Certification Label located on the driver's door sill.

## Overloading



### WARNING

The Gross Axle Weight Rating (GAWR) and the Gross Vehicle Weight Rating (GVWR) for your vehicle are on the Certification Label attached to the driver's (or front passenger's) door. Exceeding these ratings can cause an accident or vehicle damage. You can calculate the weight of your load by weighing the items (and people) before putting them in the vehicle. Be careful not to overload your vehicle.



# 7. Driver Assistance System

---

Cruise Control (CC) .....	7-2
Cruise Control operation .....	7-2
Rear View Monitor (RVM) .....	7-6
Rear View Monitor operation .....	7-6
Rear View Monitor malfunction and limitations .....	7-7
Reverse Parking Distance Warning (PDW) .....	7-8
Reverse Parking Distance Warning settings.....	7-8
Reverse Parking Distance Warning operation.....	7-9
Reverse Parking Distance Warning malfunction and precautions .....	7-9

## CRUISE CONTROL (CC) (IF EQUIPPED)



- (1) Cruise indicator
- (2) Set speed

Cruise Control will allow you to drive at speeds above 30 km/h (20 mph) without depressing the accelerator pedal.

### **NOTICE**

During cruise-speed driving of a manual transmission vehicle, do not shift into neutral without depressing the clutch pedal, as the engine will be overrevved. If this happens, depress the clutch pedal or press the Driving Assist button.

## Cruise Control operation

### *To set speed*



1. Press the Driving Assist button on the steering wheel to turn the function on. The CRUISE indicator on the cluster will illuminate.
2. Accelerate to the desired speed, which must be more than 30 km/h (20 mph).

### **i** Information

For manual transmission vehicles, you should depress the brake pedal at least once to set the cruise control after starting the engine.



3. Push the SET- switch down, and release it. The Set indicator on the cluster display will illuminate.
4. Release the accelerator pedal.

## **i** Information

The vehicle may slow down or speed up slightly while going uphill or downhill.

### *To increase speed*



OAI3063012L

- Push the RES+ switch up and hold it, while monitoring the speedometer on the instrument cluster. Release the toggle switch when the desired speed is shown and the vehicle will accelerate to that speed.
- Push the RES+ switch up and release it immediately. The set speed will increase 2 km/h (1.2 mph) each time the toggle switch is operated in this manner.
- Depress the accelerator pedal. When the vehicle attains the desired speed, push the SET- switch down.

### *To decrease speed*



OAI3063011L

- Push the SET- switch down and hold it. Your vehicle will gradually slow down. Release the toggle switch at the speed you want to maintain.
- Push the SET- switch down and release it immediately. The set speed will decrease 2 km/h (1.2 mph) each time the toggle switch is operated in this manner.
- Lightly tap the brake pedal. When the vehicle attains the desired speed, push the SET- switch down.

### *To temporarily accelerate*

Depress the accelerator pedal. When you take your foot off the accelerator, the vehicle will return to the previously set speed.

If you push SET- switch down at the increased speed, Cruise Control will maintain the increased speed.

*To temporarily pause Cruise Control*



OAI3063019L

Cruise Control will be paused when:

- Depressing the brake pedal.
- Depressing the clutch pedal. (for manual transmission vehicle)
- Pressing the CANCEL button located on the steering wheel. The indicator will turn off.
- Decreasing the vehicle speed lower than the memory speed by 20 km/h (12 mph).
- Decreasing the vehicle speed to less than approximately 30 km/h (20 mph).

*To resume Cruise Control*



OAI3063012L

Push the RES+ switch up. If the vehicle speed is over 30 km/h (20 mph), the vehicle will resume the preset speed.

**i** Information

**Each of the above actions will cancel Cruise Control operation (the SET indicator light in the instrument cluster will go off), but only pressing the Driving Assist button will turn the function off. If you wish to resume Cruise Control operation, push the RES+ switch up located on your steering wheel. You will return to your previously set speed, unless the function was turned off using the Driving Assist button.**

### To turn off the Cruise Control



Pressing the Driving Assist button. The cruise indicator will go off.

### WARNING

Take the following precautions when using Cruise Control:

- Always set the vehicle speed to the speed limit in your country.
- Keep Cruise Control off when the function is not in use, to avoid inadvertently setting a speed. Check that the Cruise (CC) CRUISE indicator is off.
- Cruise Control does not substitute for proper and safe driving. It is the responsibility of the driver to always drive safely and should always be aware of unexpected and sudden situations from occurring.
- Always drive cautiously to prevent unexpected and sudden situations from occurring. Pay attention to the road conditions at all times.
- Do not use Cruise Control when it may be unsafe to keep the vehicle at a constant speed:
  - When driving in heavy traffic, or when traffic conditions make it difficult to drive at a constant speed
  - When driving on rainy, icy, or snow-covered roads
  - When driving on hilly or windy roads
  - When driving in windy areas
  - When driving with limited view (possibly due to bad weather, such as fog, snow, rain and sandstorm)
- Do not use Cruise Control when towing a trailer.

## REAR VIEW MONITOR (RVM) (IF EQUIPPED)

Rear View Monitor shows the area behind the vehicle to assist you when parking or backing up.

### Detecting sensor

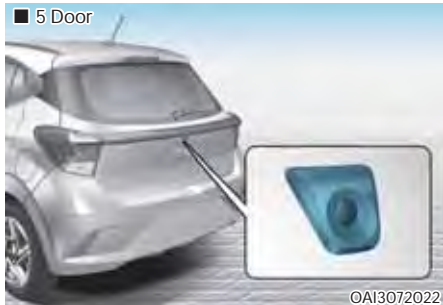

Refer to the picture above for the detailed location of the detecting sensor.

### Rear View Monitor operation

#### Rear view

- Shift the gear to R (Reverse), the image will appear on the screen.

#### Off conditions

- The rear view cannot be turned off when the gear is in R (Reverse).
- Shift the gear from R (Reverse) to P (Park), the rear view will turn off.

### Rear view while driving (if equipped)



The driver is able to check the rear view on the screen while driving, it is to assist with safe driving.

#### Operating conditions

- The ignition switch is turned ON.
- The rear view monitor button (1) is pressed when gear shift status is D (Drive) or N (Neutral).

#### Off conditions

The rear view monitor button (1) is pressed again.

#### When operating

- When the vehicle is reversing, the screen switches to the parking guidance screen.
- When Rear view while driving is displayed on the screen, an icon (ⓘ) will appear on the upper right side of the screen indicating that the rear view is being displayed.

### Rear View Monitor malfunction and limitations

#### Rear View Monitor malfunction

When Rear View Monitor is not working properly, or the screen flickers, or the camera image does not display normally, we recommend that the function be inspected by an authorized HYUNDAI dealer.

#### Limitations of the Rear View Monitor

When the vehicle is stopped for a long time in winter or when the vehicle is parked in an indoor parking lot, the exhaust fumes may temporarily blur the image.

#### WARNING

- The rear view camera does not cover the complete area behind the vehicle. The driver should always check the rear area directly through the inside and outside rearview mirror before parking or backing up.
- The image shown on the screen may differ from the actual distance of the object. Make sure to directly check the vehicle's surroundings for safety.
- Always keep the rear view camera lens clean. If the lens is covered with foreign material, it may adversely affect camera performance and Rear View Monitor may not operate normally. However, do not use chemical solvents such as strong detergents containing high alkaline or volatile organic solvents (gasoline, acetone etc.). This may damage the camera lens.

## REVERSE PARKING DISTANCE WARNING (PDW)

Reverse Parking Distance Warning will help warn the driver if an obstacle is detected within a certain distance when the vehicle is moving in reverse at low speeds.

### Detecting sensor



[A]: Rear sensors

Refer to the picture above for the detailed location of the detecting sensors.

### Reverse Parking Distance Warning settings

#### Warning Volume

Select 'Driver assistance → Warning volume' from the cluster Settings menu to change the Warning volume to 'High', 'Medium', or 'Low' for Reverse Parking Distance Warning.



If you change the Warning Volume, the warning volume of other Driver Assistance systems may change.



## Reverse Parking Distance Warning operation

### *Reverse Parking Distance Warning*

- Reverse Parking Distance Warning will operate when the gear is in R (Reverse).
- Reverse Parking Distance Warning detects a person, animal or object in the rear when the vehicle's rearward speed is below 10 km/h (6 mph).

Distance from object	Warning indicator while driving backward	Warning sound
100 ~ 61 cm (39 ~ 24 in.)		Buzzer beeps intermittently
60 ~ 31 cm (24 ~ 12 in.)		Beeps more frequently
within 30 cm (12 in.)		Beeps continuously

- The corresponding indicator will illuminate whenever each sensor detects a person, animal or object in its sensing range. Also an audible warning will sound.
- When more than two objects are detected at the same time, the closest one will be warned with an audible warning.
- The shape of the indicator in the illustration may differ from the actual vehicle.

## Reverse Parking Distance Warning malfunction and precautions

### *Reverse Parking Distance Warning malfunction*

After starting the engine, a beep will sound when the gear is shifted to R (Reverse) to indicate the function is operating properly.

However, if one or more of the following occurs, first check whether the sensor is damaged or blocked with foreign materials. If it still does not work properly, we recommend that the function be inspected by an authorized HYUNDAI dealer.

- The audible warning does not sound.
- The buzzer sounds intermittently.
- The 'Sensor error or blockage. System limited' warning message appears on the cluster.





## WARNING

- **Reverse Parking Distance Warning is a supplemental function. The operation of the function can be affected by several factors (including environmental conditions). It is the responsibility of the driver to always check the rear view before and while parking.**
- **Your new vehicle warranty does not cover any accidents or damage to the vehicle due to the malfunction of Reverse Parking Distance Warning.**
- **Pay close attention when driving near objects, pedestrians, and especially children. Some objects may not be detected by the ultrasonic sensors, due to the objects distance, size or material, all of which can limit the effectiveness of the sensor.**

### *Limitations of Reverse Parking Distance Warning*

- Reverse Parking Distance Warning may not operate normally when:
  - Moisture is frozen to the sensor
  - Sensor is covered with foreign materials, such as snow or water (Reverse Parking Distance Warning will operate normally when such foreign materials are removed.)
  - The weather is extremely hot or cold
  - The sensor or sensor assembly is disassembled
  - The surface of the sensor is pressed hard or an impact is applied with a hard object
  - The surface of the sensor is scratched with a sharp object
  - The sensors or its surrounding areas are directly sprayed with high pressure washer
- Reverse Parking Distance Warning may malfunction when:
  - Heavy rain or water spray is present
  - Water flows on the surface of the sensor
  - Affected by another vehicle's sensors
  - The sensor is covered with snow
  - Driving on uneven roads, gravel roads or bushes
  - Objects that generate ultrasonic waves are near the sensor
  - Installing the license plate differently from the original location
  - The vehicle bumper height or sensor installation has been modified
  - Attaching equipments or accessories around the sensors
- The following objects may not be detected:
  - Sharp or slim objects such as ropes, chains or small poles.
  - Objects, which tend to absorb sensor frequency, such as clothes, spongy material or snow.
  - Objects smaller than 100 cm (40 in.) in length and narrower than 14 cm (6 in.) in diameter.
  - Pedestrians, animals or objects that are very close to the sensors
- Parking Distance Warning Indicators may be displayed differently from the actual detected location when the obstacle is located between the sensors.
- Parking Distance Warning indicator may not occur sequentially depending on vehicle speed or obstacle shape.
- If Reverse Parking Distance Warning needs repair, we recommend that Reverse Parking Distance Warning be inspected by an authorized HYUNDAI dealer.

# 8. Emergency Situations

Hazard warning flasher .....	8-2
In case of an emergency while driving.....	8-2
If the engine stalls while driving .....	8-2
If the engine stalls at a crossroad or crossing.....	8-2
If you have a flat tire while driving .....	8-3
If the engine will not start .....	8-3
If the engine doesn't turn over or turns over slowly.....	8-3
If the engine turns over normally but doesn't start .....	8-3
Jump starting.....	8-4
If the engine overheats.....	8-7
Tire pressure monitoring system (TPMS) .....	8-9
Check tire pressure .....	8-9
Tire pressure monitoring system.....	8-10
Low tire pressure telltale .....	8-11
Low tire pressure position telltale and tire pressure telltale.....	8-11
TPMS (Tire Pressure Monitoring System) malfunction indicator.....	8-12
Changing a tire with TPMS .....	8-12
If you have a flat tire .....	8-14
Jack and tools .....	8-14
Removing and storing the spare tire.....	8-14
Changing tires .....	8-15
Jack label .....	8-19
EC declaration of conformity for jack .....	8-20
Towing .....	8-21
Towing service.....	8-21
Removable towing hook .....	8-22
Emergency towing .....	8-23
Emergency commodity .....	8-25
First aid kit .....	8-25
Triangle reflector .....	8-25

## HAZARD WARNING FLASHER



The hazard warning flasher serves as a warning to other drivers to exercise extreme caution when approaching, overtaking, or passing your vehicle.

It should be used whenever emergency repairs are being made or when the vehicle is stopped near the edge of a roadway.

To turn the hazard warning flasher on or off, press the hazard warning flasher button with the ignition switch in any position. The button is located in the crash pad garnish panel.

All turn signal lights will flash simultaneously.

- The hazard warning flasher operates whether your vehicle is running or not.
- The turn signals do not work when the hazard flasher is on.

## IN CASE OF AN EMERGENCY WHILE DRIVING

### If the engine stalls while driving

- Reduce your speed gradually, keeping a straight line. Move cautiously off the road to a safe place.
- Turn on your hazard warning flasher.
- Try to start the engine again. If your vehicle will not start, we recommend that you contact an authorized HYUNDAI dealer.

### If the engine stalls at a crossroad or crossing

If the engine stalls at a crossroad or crossing, if safe to do so, move the shift lever to the N (Neutral) position and then push the vehicle to a safe location.

- If your vehicle has a manual transmission not equipped with a ignition lock switch, the vehicle can move forward by shifting to the 2(second) or 3(third) gear and then turning the starter without depressing the clutch pedal.

## If you have a flat tire while driving

If a tire goes flat while you are driving:

- Take your foot off the accelerator pedal and let the vehicle slow down while driving straight ahead. Do not apply the brakes immediately or attempt to pull off the road as this may cause loss of vehicle control resulting in an accident. When the vehicle has slowed to such a speed that it is safe to do so, brake carefully and pull off the road. Drive off the road as far as possible and park on firm, level ground. If you are on a divided highway, do not park in the median area between the two traffic lanes.
- When the vehicle is stopped, press the hazard warning flasher button, move the shift lever into N (Neutral, for Automated manual transmission) or neutral (for manual transmission vehicle), apply the parking brake, and place the ignition switch in the LOCK/OFF position.
- Have all passengers get out of the vehicle. Be sure they all get out on the side of the vehicle that is away from traffic.
- When you have a flat tire, follow the instructions provided later in this chapter.

## IF THE ENGINE WILL NOT START

### If the engine doesn't turn over or turns over slowly

- Be sure the gear is in N (Neutral). The engine starts only when the shift lever is in N (Neutral).
- Check the battery connections to be sure they are clean and tight.
- Turn on the interior light. If the light dims or goes out when you operate the starter, the battery is drained.

Do not push or pull the vehicle to start it. This could cause damage to your vehicle.

See instructions for "Jump Starting" provided in this chapter.



### WARNING

Push or pull starting the vehicle may cause the catalytic converter to overload which can lead to damage to the emission control system.

### If the engine turns over normally but doesn't start

- Check the fuel level and add fuel if necessary.

If the engine still does not start, we recommend that you call an authorized HYUNDAI dealer for assistance.

## JUMP STARTING

Jump starting can be dangerous if done incorrectly. Follow the jump starting procedure in this section to avoid serious injury or damage to your vehicle. If in doubt about how to properly jump start your vehicle, we strongly recommend that you have a service technician or towing service do it for you.



### WARNING

To prevent **SERIOUS INJURY** or **DEATH** to you or bystanders, always follow these precautions when working near or handling the battery:



Always read and follow instructions carefully when handling a battery.



Wear eye protection designed to protect the eyes from acid splashes.



Keep all flames, sparks, or smoking materials away from the battery.



Hydrogen is always present in battery cells, is highly combustible, and may explode if ignited.



Keep batteries out of reach of children.



Batteries contain sulfuric acid which is highly corrosive. Do not allow acid to contact your eyes, skin or clothing.

If acid gets into your eyes, flush your eyes with clean water for at least 15 minutes and get immediate medical attention. If acid gets on your skin, thoroughly wash the area. If you feel pain or a burning sensation, get medical attention immediately.

- When lifting a plastic-cased battery, excessive pressure on the case may cause battery acid to leak. Lift with a battery carrier or with your hands on opposite corners.
- Do not attempt to jump start your vehicle if your battery is frozen.
- NEVER attempt to recharge the battery when the vehicle's battery cables are connected to the battery.
- The electrical ignition system works with high voltage. NEVER touch these components with the engine running or when the ignition switch is in the ON position.
- Do not allow the (+) and (-) jumper cables to touch. It may cause sparks.
- The battery may rupture or explode when you jump start with a low or frozen battery.
- Never attempt jump start if you observe cracks, leaks or other damage on Battery.

## CAUTION

- Improper jump starting procedure can result in battery explosion and acid burn hazard.
- Loosely connected battery cables could damage the electronic control units.
- To disconnect battery terminals wait for at least 2 minutes to allow discharge of high voltage or it could lead to personal injury.
- While disconnecting, always disconnect the -VE terminal first and while connecting, always connect the -VE terminal last.

## **NOTICE**

To prevent damage to your vehicle:

- Only use a 12-volt power supply (battery or jumper system) to jump start your vehicle.
- Do not attempt to jump start your vehicle by push-starting.

## Information



**An inappropriately disposed battery can be harmful to the environment and human health. Dispose the battery according to your local law(s) or regulation.**

## *Jump starting procedure*

1. Position the vehicles close enough that the jumper cables will reach, but do not allow the vehicles to touch.
2. Avoid fans or any moving parts in the engine compartment at all times, even when the vehicles are turned off.
3. Turn off all electrical devices such as radios, lights, air conditioning, etc. Put the vehicles in N (Neutral, for Automated manual transmission vehicle) or neutral (for manual transmission vehicle), and set the parking brakes. Turn both vehicles OFF.

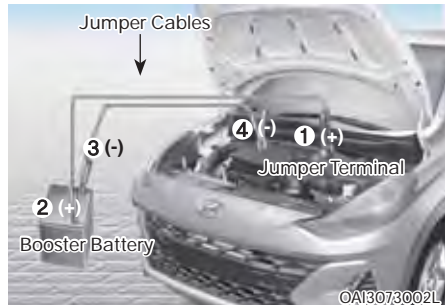

4. Connect the jumper cables in the exact sequence shown in the illustration. First connect one jumper cable to the red, positive (+) jumper terminal of your vehicle (1).
5. Connect the other end of the jumper cable to the red, positive (+) battery/jumper terminal of the assisting vehicle (2).
6. Connect the second jumper cable to the black, negative (-) battery/chassis ground of the assisting vehicle (3).

7. Connect the other end of the second jumper cable to the black, negative (-) chassis ground of your vehicle (4).

Do not allow the jumper cables to contact anything except the correct battery or jumper terminals or the correct ground. Do not lean over the battery when making connections.

8. Start the engine of the assisting vehicle and let it run at approximately 2,000 RPM for a few minutes. Then start your vehicle.



### WARNING

**Do not connect the jumper cable to the negative (-) jumper terminal of the discharged battery. A spark could cause the battery to explode and lead to a personal injury or vehicle damage.**

If your vehicle will not start after a few attempts, it probably requires servicing. In this event, please seek qualified assistance. If the cause of your battery discharging is not apparent, we recommend that your vehicle be checked by an authorized HYUNDAI dealer.



### WARNING

**Never connect Jumper Cable directly to the negative (-) terminal of discharged Battery (Your Vehicle Battery), or an Explosion may occur.**

Disconnect the jumper cables in the exact reverse order you connected them:

1. Disconnect the jumper cable from the black, negative (-) chassis ground of your vehicle (4).
2. Disconnect the other end of the jumper cable from the black, negative (-) battery/chassis ground of the assisting vehicle (3).
3. Disconnect the second jumper cable from the red, positive (+) battery/jumper terminal of the assisting vehicle (2).
4. Disconnect the other end of the jumper cable from the red, positive (+) jumper terminal of your vehicle (1).



### WARNING

**While jump starting your vehicle, avoid the positive (+) and negative (-) cables to come in contact. A spark could cause personal injury.**



## IF THE ENGINE OVERHEATS

If your temperature gauge indicates overheating, you experience a loss of power, or hear loud pinging or knocking, the engine may be overheating. If this happens, you should:

1. Pull off the road and stop as soon as it is safe to do so.
2. Place the shift lever in N (Neutral, for Automated manual transmission vehicle) or neutral (for manual transmission vehicle) and set the parking brake. If the air conditioning is ON, turn it OFF.
3. If the engine coolant is running out under the vehicle or steam is coming out from the hood, stop the engine. Do not open the hood until the coolant has stopped running or the steaming has stopped. If there is no visible loss of engine coolant and no steam, leave the engine running and check to be sure the engine cooling fan is operating. If the fan is not running, turn the engine off.

### WARNING



While the engine is running, keep hands, clothing and tools away from the moving parts such as the cooling fan and drive belt to prevent serious injury.

4. Check for coolant leaking from the radiator, hoses or under the vehicle. (If the air conditioning had been in use, it is normal for cold water to be draining from it when you stop.)
5. If the engine coolant is leaking out, stop the engine immediately and we recommend that you call an authorized HYUNDAI dealer for assistance.

### WARNING



**NEVER** remove the radiator cap or the drain plug while the engine and radiator are hot. Hot coolant and steam may blow out under pressure, causing serious injury.

Turn the engine off and wait until the engine cools down. Use extreme care when removing the radiator cap. Wrap a thick towel around it, and turn it counterclockwise slowly to the first stop. Step back while the pressure is released from the cooling system. When you are sure all the pressure has been released, press down on the cap, using a thick towel, and continue turning counterclockwise to remove it.

6. If you cannot find the cause of the overheating, wait until the engine temperature has returned to normal. Then, if coolant has been lost, carefully add coolant to the reservoir to bring the fluid level in the reservoir up to the halfway mark.
7. Proceed with caution, keeping alert for further signs of overheating. If overheating happens again, we recommend that you call an authorized HYUNDAI dealer for assistance.

### **NOTICE**

- **Serious loss of coolant indicates a leak in the cooling system and we recommend the system be checked by an authorized HYUNDAI dealer.**
- **When the engine overheats from low engine coolant, suddenly adding engine coolant may cause cracks in the engine. To prevent damage, add engine coolant slowly in small quantities.**

## TIRE PRESSURE MONITORING SYSTEM (TPMS) (IF EQUIPPED)



- (1) Low tire pressure telltale / TPMS malfunction indicator
- (2) Low tire pressure position telltale and tire pressure telltale (Shown on the cluster display)

### Check tire pressure



- You can check the tire pressure in the Assist mode on the cluster.  
**Refer to the "User settings mode" in chapter 4.**
- Tire pressure is displayed 1~2 minutes later after driving.
- If tire pressure is not displayed when the vehicle is stopped, "Drive to display" message will appear. After driving, check the tire pressure.
- The displayed tire pressure values may differ from those measured with a tire pressure gauge.
- You can change the tire pressure unit in the User Settings mode on the instrument cluster.
  - psi, kpa, bar (**Refer to the "User settings mode" in chapter 4.**)

### Tire pressure monitoring system



#### WARNING

**Over-inflation or under-inflation can reduce tire life, adversely affect vehicle handling, and lead to sudden tire failure that may cause loss of vehicle control resulting in an accident.**

Each tire, including the spare (if provided), should be checked monthly when cold and inflated to the inflation pressure recommended by the vehicle manufacturer on the vehicle placard or tire inflation pressure label. (If your vehicle has tires of a different size than the size indicated on the vehicle placard or tire inflation pressure label, you should determine the proper tire inflation pressure for those tires.)

As an added safety feature, your vehicle has been equipped with a tire pressure monitoring system (TPMS) that illuminates a low tire pressure telltale when one or more of your tires is significantly under-inflated.

Accordingly, when the low tire pressure telltale illuminates, you should stop and check your tires as soon as possible, and inflate them to the proper pressure. Driving on a significantly under-inflated tire causes the tire to overheat and can lead to tire failure. Under-inflation also reduces fuel efficiency and tire tread life, and may affect the vehicle's handling and stopping ability.

Please note that the TPMS is not a substitute for proper tire maintenance, and it is the driver's responsibility to maintain correct tire pressure, even if under-inflation has not reached the level to trigger illumination of the TPMS low tire pressure telltale.

Your vehicle has also been equipped with a TPMS malfunction indicator to indicate when the system is not operating properly. The TPMS malfunction indicator is combined with the low tire pressure telltale. When the system detects a malfunction, the telltale will flash for approximately one minute and then remain continuously illuminated. This sequence will continue upon subsequent vehicle start-ups as long as the malfunction exists. When the malfunction indicator is illuminated, the system may not be able to detect or signal low tire pressure as intended. TPMS malfunctions may occur for a variety of reasons, including the installation of replacement or alternate tires or wheels on the vehicle that prevent the TPMS from functioning properly. Always check the TPMS malfunction telltale after replacing one or more tires or wheels on your vehicle to ensure that the replacement or alternate tires and wheels allow the TPMS to continue to function properly.

#### NOTICE

**If any of the below happens, we recommend that you have the system checked by an authorized HYUNDAI dealer.**

- 1. The Low Tire Pressure Telltale/ TPMS Malfunction Indicator does not illuminate for 3 seconds when the Engine Start/Stop button is pressed to the ON position or when the engine is running.**
- 2. The TPMS Malfunction Indicator remains illuminated after blinking for approximately 1 minute.**
- 3. The Low Tire Pressure Position Telltale remains illuminated.**



## Low tire pressure telltale

## Low tire pressure position telltale and tire pressure telltale



When the tire pressure monitoring system warning indicators are illuminated and a warning message displayed on the cluster display, one or more of your tires is significantly under-inflated. The low tire pressure position telltale light will indicate which tire is significantly under-inflated by illuminating the corresponding position light.

If either telltale illuminates, immediately reduce your speed, avoid hard cornering and anticipate increased stopping distances. You should stop and check your tires as soon as possible. Inflate the tires to the proper pressure as indicated on the vehicle's placard or tire inflation pressure label located on the driver's side center pillar outer panel. If you cannot reach a service station or if the tire cannot hold the newly added air, replace the low pressure tire with a spare tire.

If you drive the vehicle for about 10 minutes at speeds above 25 km/h after replacing the low pressure tire with the spare tire, the following will happen:

- The TPMS malfunction indicator may blink for approximately 1 minute and then remain continuously illuminated because the TPMS sensor is not mounted on the spare wheel.

### NOTICE

In winter or cold weather, the low tire pressure telltale may be illuminated if the tire pressure was adjusted to the recommended tire inflation pressure in warm weather. It does not mean your TPMS is malfunctioning because the decreased temperature leads to a proportional lowering of tire pressure.

When you drive your vehicle from a warm area to a cold area or from a cold area to a warm area, or the outside temperature is greatly higher or lower, you should check the tire inflation pressure and adjust the tires to the recommended tire inflation pressure.

### WARNING

#### Low pressure damage

Significantly low tire pressure makes the vehicle unstable and can contribute to loss of vehicle control and increased braking distances.

Continued driving on low pressure tires can cause the tires to overheat and fail.



### TPMS (Tire Pressure Monitoring System) malfunction indicator

The TPMS malfunction indicator will illuminate after it blinks for approximately one minute when there is a problem with the Tire Pressure Monitoring System.

We recommend that the system be checked by an authorized HYUNDAI dealer.

#### **NOTICE**

If there is a malfunction with the TPMS, the low tire pressure position telltale will not be displayed even though the vehicle has an under-inflated tire.

#### **NOTICE**

The TPMS Malfunction Indicator may illuminate after blinking for one minute if the vehicle is near electric power supply cables or radio transmitters such as police stations, government and public offices, broadcasting stations, military installations, airports, transmitting towers, etc.

Additionally, the TPMS Malfunction Indicator may illuminate if snow chains are used or electronic devices such as computers, chargers, remote starters, navigation, etc. This may interfere with normal operation of the TPMS.

## Changing a tire with TPMS

If you have a flat tire, the Low Tire Pressure and Position telltales will come on. We recommend that the flat tire be repaired by an authorized HYUNDAI dealer as soon as possible or replace the flat tire with the spare tire.

#### **NOTICE**

**It is recommended that you do not use a puncture-repairing agent not approved by an authorized HYUNDAI dealer or the equivalent specified for your vehicle to repair and/or inflate a low pressure tire. Tire sealant not approved by an authorized HYUNDAI dealer or the equivalent specified for your vehicle may damage the tire pressure sensor.**

The spare tire (if equipped) does not come with a tire pressure monitoring sensor. When the low pressure tire or the flat tire is replaced with the spare tire, the Low Tire Pressure Telltale will remain on. Also, the TPMS Malfunction Indicator will illuminate after blinking for one minute if the vehicle is driven at speed above 25 km/h (15.5 mph) for approximately 10 minutes.

Once the original wheel equipped with a tire pressure monitoring sensor is reinflated to the recommended pressure and reinstalled on the vehicle, the Low Tire Pressure Telltale and TPMS Malfunction Indicator will go off within a few minutes of driving.

If the indicators do not extinguish after a few minutes we recommend to consult an authorized HYUNDAI dealer.

Each wheel is equipped with a tire pressure sensor mounted inside the tire behind the valve stem (except for the spare tire). You must use TPMS specific wheels. It is recommended that you always have your tires serviced by an authorized HYUNDAI dealer.

You may not be able to identify a tire with low pressure by simply looking at it. Always use a good quality tire pressure gauge to measure. Please note that a tire that is hot (from being driven) will have a higher pressure measurement than a tire that is cold.

A cold tire means the vehicle has been sitting for 3 hours and driven for less than 1.6 km (1 mile) in that 3 hour period.

Allow the tire to cool before measuring the inflation pressure. Always be sure the tire is cold before inflating to the recommended pressure.

### **WARNING**

- The TPMS cannot alert you to severe and sudden tire damage caused by external factors such as nails or road debris.
- If you feel any vehicle instability, immediately take your foot off the accelerator, apply the brakes gradually and with light force, and slowly move to a safe position off the road.

### **WARNING**

#### Protecting TPMS

**Tampering with, modifying, or disabling the Tire Pressure Monitoring System (TPMS) components may interfere with the system's ability to warn the driver of low tire pressure conditions and/or TPMS malfunctions. Tampering with, modifying, or disabling the Tire Pressure Monitoring System (TPMS) components may void the warranty for that portion of the vehicle.**

## IF YOU HAVE A FLAT TIRE



### WARNING

Changing a tire can be dangerous. Follow the instructions in this section when changing a tire to reduce the risk of serious injury or death.

### Jack and tools



- ① Jack
- ② Jack handle
- ③ Wheel lug nut wrench
- ④ Towing hook

The jack, jack handle, and wheel lug nut wrench, towing hook are stored in the luggage compartment.

The jack is provided for emergency tire changing only.

### Removing and storing the spare tire



Turn the winged hold down bolt counterclockwise to remove the spare tire.

Store the spare tire in the same compartment by turning the winged hold down bolt clockwise.

To prevent the spare tire and tools from “rattling” store them in their proper location.



If it is hard to loosen the tire hold-down wing bolt by hand, you can loosen it easily using the wheel lug nut wrench.

1. Put the wrench (1) inside of the tire hold-down wing bolt.
2. Turn the tire hold-down wing bolt counterclockwise with the wrench.



## Changing tires



### WARNING

A vehicle can slip or roll off of a jack causing serious injury or death to you or those nearby. Take the following safety precautions:

- Do not get under a vehicle that is supported by a jack.
- NEVER attempt to change a tire in the lane of traffic. ALWAYS move the vehicle completely off the road on level, firm ground away from traffic before trying to change a tire. If you cannot find a level, firm place off the road, call a towing service for assistance.
- Be sure to use the jack provided with the vehicle.
- ALWAYS place the jack on the designated jacking positions on the vehicle and NEVER on the bumpers or any other part of the vehicle for jacking support.
- Do not start or run the engine while the vehicle is on the jack.
- Do not allow anyone to remain in the vehicle while it is on the jack.
- Keep children away from the road and the vehicle.

Follow these steps to change your vehicle's tire:

1. Park on a level and firm surface.
2. Move the shift lever into N (Neutral, for Automated manual transmission vehicle) or neutral (for manual transmission vehicle), apply the parking brake, and place the ignition switch in the LOCK/OFF position.
3. Press the hazard warning flasher button.
4. Remove the wheel lug nut wrench, jack, jack handle, and spare tire from the vehicle.
5. Block both the front and rear of the tire diagonally opposite of the tire you are changing.



©AI3082102

6. Loosen the wheel lug nuts counterclockwise one turn each in the order shown above, but do not remove any lug nuts until the tire has been raised off of the ground.

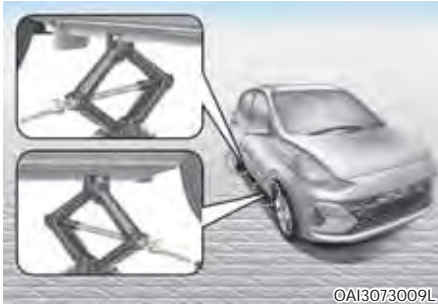

7. Place the jack at the designated jacking position under the frame closest to the tire you are changing. The jacking positions are plates welded to the frame with two tabs and a raised dot. Never jack any other position or part of the vehicle.



8. Insert the jack handle into the jack and turn it clockwise, raising the vehicle until the tire clears the ground. Before removing the wheel lug nuts, make sure the vehicle is stable on the jack.
9. Loosen the lug nuts with the wheel lug nut wrench and remove them with your fingers. Remove the wheel from the studs and lay it flat on the ground out of the way. Before removing the wheel lug nuts, make sure the vehicle is stable on the jack.

10. Install the spare tire onto the studs of the hub.
11. Tighten the lug nuts with your fingers onto the studs with the smaller end of the lug nuts closest to the wheel.
12. Lower the vehicle to the ground by turning the jack handle counterclockwise.



13. Use the wheel lug nut wrench to tighten the lug nuts in the order shown. Double-check each lug nut until they are tight. After changing tires, we recommend that an authorized HYUNDAI dealer tighten the lug nuts to their proper torque as soon as possible. **The wheel lug nut should be tightened to 11-13 kgf.m (79-94 lbf.ft).**

If you have a tire gauge, check the tire pressure (see “Tires and Wheels” in chapter 2 for tire pressure instructions.). If the pressure is lower or higher than recommended, drive slowly to the nearest service station and adjust it to the recommended pressure. Always reinstall the valve cap after checking or adjusting tire pressure. If the cap is not replaced, air may leak from the tire. If you lose a valve cap, buy another and install it as soon as possible. After changing tires, secure the flat tire and return the jack and tools to their proper storage locations.

### Information

**Check the tire pressure as soon as possible after installing a spare tire. Adjust it to the recommended pressure.**

### **NOTICE**

Your vehicle has metric threads on the studs and lug nuts. Make certain during tire changing that the same nuts that were removed are reinstalled. If you have to replace your lug nuts make sure they have metric threads to avoid damaging the studs and ensure the wheel is properly secured to the hub. We recommend that you consult an authorized HYUNDAI dealer for assistance.

If any of the equipment such as the jack, lug nuts, studs, or other equipment is damaged or in poor condition, do not attempt to change the tire and call for assistance.

### ***Use of compact spare tires (if equipped)***

Compact spare tires are designed for emergency use only. Drive carefully on the compact spare tire and always follow the safety precautions.

### **WARNING**

**To prevent compact spare tire failure and loss of control possibly resulting in an accident:**

- Use the compact spare tire only in an emergency.
- NEVER operate your vehicle over 80 km/h (50 mph).
- Do not exceed the vehicle's maximum load rating or the load carrying capacity shown on the sidewall of the compact spare tire.
- Do not use the compact spare tire continuously. Repair or replace the original tire as soon as possible to avoid failure of the compact spare tire.

When driving with the compact spare tire mounted to your vehicle:

- Check the tire pressure after installing the compact spare tire. The compact spare tire should be inflated to 420 kPa (60 psi).
- Do not take this vehicle through an automatic car wash while the compact spare tire is installed.
- Do not use the compact spare tire on any other vehicle because this tire has been designed especially for your vehicle.
- The compact spare tire's tread life is shorter than a regular tire. Inspect your compact spare tire regularly and replace worn compact spare tires with the same size and design, mounted on the same wheel.
- Do not use more than one compact spare tire at a time.
- Do not tow a trailer while the compact spare tire is installed.

### Information

**When the original tire and wheel are repaired and reinstalled on the vehicle, the lug nut torque must be set correctly to prevent wheel vibration. The correct lug nut tightening torque is 11~13 kgf.m (79~94 lbf.ft).**

### **NOTICE**

To prevent damaging the compact spare tire and your vehicle:

- Drive slowly enough for the road conditions to avoid all hazards, such as a potholes or debris.
- Avoid driving over obstacles. The compact spare tire diameter is smaller than the diameter of a conventional tire and reduces the ground clearance approximately 25 mm (1 inch).
- Do not use tire chains on the compact spare tire. Because of the smaller size, a tire chain will not fit properly.
- Do not use the compact spare tire on any other wheels, nor should standard tires, snow tires, wheel covers or trim rings be used with the compact spare wheel.
- Do not suddenly accelerate or decelerate 0 ↔ 40 km/h (0 ↔ 25 mph) in any driving mode. It may cause leakage of transfer oil.

## Jack label

### ■ Example

- Type A

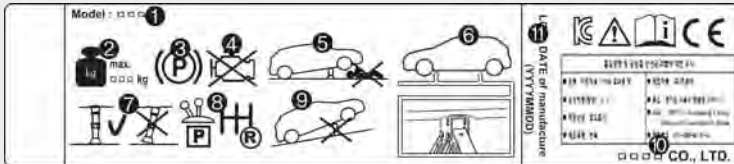

OHYK065010

- Type B

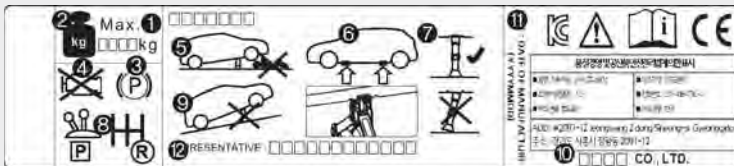

OHYK065011

※ The actual Jack label in the vehicle may differ from the illustration.  
For more detailed specifications, refer to the label attached to the jack.

1. Model Name
2. Maximum allowable load
3. When using the jack, set your parking brake.
4. When using the jack, stop the engine.
5. Do not get under a vehicle that is supported by a jack.
6. The designated locations under the frame
7. When supporting the vehicle, the base plate of jack must be vertical under the lifting point.
8. Shift into Reverse gear on vehicles with manual transmission or move the shift lever to the N (Neutral) position on vehicles with Automated manual transmission
9. The jack should be used on firm level ground.
10. Jack manufacture
11. Production date
12. Representative company and address

EC Declaration of conformity for Jack

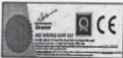
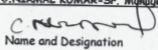
 <b>MK TRON AUTOPARTS PRIVATE LIMITED</b> (Formerly known as UMW Dongshin Motech Private Limited)		
	13.04.2022	
<b>EC DECLARATION OF CONFORMITY</b> According to EC Machinery directive 2006/42/EC Here with declare that the following products is in conformity with the provision of following EC Directive[s] he undersigned representing the manufacturer. Manufacturer Name: M/s. MKTRON AUTO PARTS PRIVATE LIMITED. Address : 14 & 133, SIDCO IND.ESTATE, THIRUMAZHISAI, CHENNAI-600 124, TAMIL NADU, INDIA Declare under our sole responsibilities that the products, Products : Jack Assemblies - Pantograph & Bottle jacks Type Designation[s] : 700 KG, 800 KG, 1000 KG & 2000 KG Serial no : NA [proto type] Year of manufacture: 2021 In which the declaration reacts is in conformity with the following standards or other normative documents EN -ISO12100 Safety of machinery-General principles for design- risk assessment and risk reduction [2010] EN ISO12100-2/A1 Safety of machinery -Basic concepts, general principles design part [2009] Part-2 Technical principles EN149A/A1 Mobile or movables jacks and associated lifting equipment [2008] Following the provisions of Directives: 2006/42/EC Directive on the approximation of the laws of member states relating to machinery Directive [OJL157 Jun, 2006] <u>MKTRON AUTO PARTS PVT LTD, INDIA /02 09 2021, C.NIRMAL KUMAR-Sr. Manager - Operation</u> Name & Place of  Name and Designation <ul style="list-style-type: none"> <li>T.C.F Compiling Person: QS Zurich AG</li> <li>P.O Box No: 6335, CH: 8050 Zurich</li> </ul>		
<b>STAMPING DIVISION</b> Plot No. A-19, Talegaon Industrial Area, Village Navlehumbre, Taluk Meval, Pune - 410 507, Maharashtra, INDIA. Tel. No.: +91-2114-305000	<b>JACK DIVISION</b> No. 14, SIDCO Industrial Estate, Thirumazhaisai, Chennai - 600124, Tamil Nadu, INDIA Tel. No. +91-44-25810211	<b>DIE CASTING DIVISION</b> 824 B. B. 160, SIDCO Industrial Estate, Thirumudrakkam, Chennai - 600 132, Tamilnadu, INDIA. Tel. No. +91-44-4904 7777
<b>CIN NO.: U29255PN2007PTC133046</b> Registered Office: Plot No. A-19, Talegaon Industrial Area, Village Navlehumbre, Tal, Meval, Pune - 410 507. Maharashtra. INDIA.		

NX4I082001

## TOWING

### Towing service

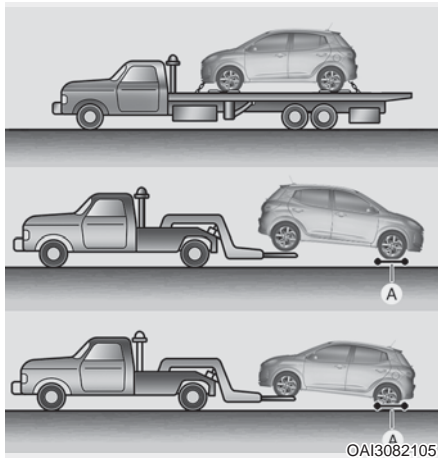

[A] : Dollies

If emergency towing is necessary, we recommend having it done by an authorized HYUNDAI dealer or a commercial tow-truck service. Proper lifting and towing procedures are necessary to prevent damage to the vehicle. The use of wheel dollies or flatbed is recommended.

It is acceptable to tow the vehicle with the rear wheels on the ground (without dollies) and the front wheels off the ground. If any of the loaded wheels or suspension components are damaged or the vehicle is being towed with the front wheels on the ground, use a towing dolly under the front wheels.

When being towed by a commercial tow truck and wheel dollies are not used, the front of the vehicle should always be lifted, not the rear.

### NOTICE

- Do not tow the vehicle with 4 wheels on the ground (such as dinghy towing behind a motorhome or other motor vehicle) as this can seriously damage the Transmission.



- Do not tow the vehicle with the front wheels on the ground as this may cause damage to the vehicle and the Transmissions.



- Do not tow with sling-type equipment. Use a wheel lift or flatbed equipment.



When towing your vehicle in an emergency without wheel dollies:

1. Place the ignition switch in the ACC position.
2. Place the shift lever in N (Neutral).
3. Release the parking brake.

### **NOTICE**

Failure to place the shift lever in N (Neutral) when being towed with the front wheels on the ground can cause internal damage to the transmission

## Removable towing hook



1. Open the tailgate/trunk, and remove the towing hook from the tool case.
2. Remove the hole cover pressing the lower part of the cover on the front bumper.
3. Install the towing hook by turning it clockwise into the hole until it is fully secured.
4. Remove the towing hook and install the cover after use.



## Emergency towing



If towing is necessary, we recommend you have it done by an authorized HYUNDAI dealer or a commercial tow truck service.

If towing service is not available in an emergency, your vehicle may be temporarily towed using a cable or chain secured to the emergency towing hook at the front (or rear) of the vehicle.

Use extreme caution when towing the vehicle with a cable or chain. A driver must be in the vehicle to steer it and operate the brakes.

Towing in this manner may be done only on hard-surfaced roads for a short distance and at low speeds.

Also, the wheels, axles, power train, steering and brakes must all be in good condition.

### CAUTION

The driver must be in the vehicle for steering and braking operations when the vehicle is being towed. Passengers other than the driver must not be in the vehicle.

Always follow these emergency towing precautions:

- Place the ignition switch in the ACC position so the steering wheel is not locked.
- Place the shift lever in N (Neutral).
- Release the parking brake.
- Depress the brake pedal with more force than normal since you will have reduced braking performance.
- More steering effort will be required because the power steering system will be disabled.
- Use a vehicle heavier than your own to tow your vehicle.
- The drivers of both vehicles should communicate with each other frequently.
- Before emergency towing, check that the hook is not broken or damaged.
- Fasten the towing cable or chain securely to the hook.
- Do not jerk the hook. Apply steady and even force.

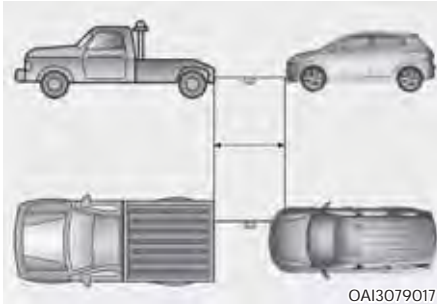

- Use a towing cable or chain less than 5 m (16 feet) long. Attach a white or red cloth (about 30 cm (12 inches) wide) in the middle of the cable or chain for easy visibility.
- Drive carefully so the towing cable or chain remains tight during towing.
- Before towing, check the Automated manual transmission for fluid leaks under your vehicle. If the Automated manual transmission fluid is leaking, flatbed equipment or a towing dolly must be used.

### **NOTICE**

Accelerate or decelerate the vehicle in a slow and gradual manner while maintaining tension on the tow rope or chain to start or drive the vehicle, otherwise tow hooks and the vehicle may be damaged.

### **NOTICE**

To avoid damage to your vehicle and vehicle components when towing:

- Always pull straight ahead when using the towing hooks. Do not pull from the side or at a vertical angle.
- Do not use the towing hooks to pull a vehicle out of mud, sand or other conditions from which the vehicle cannot be driven out under its own power.
- The vehicle should be towed at a speed of 25 km/h (15 mph) or less within the distance of 20 km (12 miles). (for Manual transmission/ Automated manual transmission vehicle)

## EMERGENCY COMMODITY (IF EQUIPPED)

Your vehicle is equipped with emergency commodities to help you respond to emergency situation.

### First aid kit

Supplies for use in giving first aid such as bandage and adhesive tape, etc., are provided.

### Triangle reflector

Place the triangle reflector on the road to warn oncoming vehicles during emergencies, such as when the vehicle is parked by the roadside due to problems.



# 9. Maintenance

Engine compartment.....	9-4
Maintenance services.....	9-5
Owner's responsibility .....	9-5
Owner maintenance precautions .....	9-5
Owner maintenance .....	9-7
Owner maintenance schedule .....	9-7
Scheduled maintenance service .....	9-9
Normal maintenance schedule (gasoline engine) .....	9-10
Maintenance under severe usage conditions (gasoline engine) .....	9-14
Normal maintenance schedule - CNG Components.....	9-16
Explanation of scheduled maintenance items .....	9-18
Engine oil.....	9-22
Checking the engine oil level .....	9-22
Changing the engine oil and filter.....	9-23
Engine coolant .....	9-25
Checking the coolant level .....	9-25
Recommended engine coolant.....	9-27
Changing the coolant .....	9-27
Brake/clutch fluid .....	9-28
Checking the brake/clutch fluid level .....	9-28
Washer fluid .....	9-30
Checking the washer fluid level .....	9-30
Parking brake .....	9-31
Checking the parking brake .....	9-31
Air cleaner .....	9-32
Filter replacement.....	9-32
Climate control air filter.....	9-34
Filter inspection.....	9-34

Filter replacement .....	9-34
Wiper blades .....	9-36
Blade inspection.....	9-36
Blade replacement .....	9-36
Battery .....	9-39
For best battery service.....	9-39
Battery capacity label .....	9-41
Battery recharging .....	9-42
Reset items .....	9-42
Battery replacement .....	9-42
Tires and wheels .....	9-43
Tire care .....	9-43
Recommended cold tire inflation pressures .....	9-43
Checking tire inflation pressure .....	9-44
Tire rotation .....	9-45
Wheel alignment and tire balance .....	9-46
Tire replacement .....	9-47
Wheel replacement .....	9-48
Tire traction .....	9-48
Tire maintenance .....	9-49
Tire sidewall labeling.....	9-49
Low aspect ratio tire.....	9-52
Fuses.....	9-54
Instrument panel fuse replacement .....	9-55
Engine compartment panel fuse replacement .....	9-57

# 9. Maintenance

Fuse/relay panel description .....	9-58
Light bulbs.....	9-69
Headlight, Parking (Position) Light, Turn Signal Light, Daytime Running Light bulb replacement .....	9-70
Side repeater light replacement .....	9-73
Rear combination light bulb replacement .....	9-74
High mounted stop light.....	9-77
License plate light bulb replacement .....	9-77
Interior light bulb replacement .....	9-78
Appearance care .....	9-79
Exterior care .....	9-79
Interior care .....	9-85
Emission control system.....	9-88
Crankcase emission control system .....	9-88
Evaporative emission control system .....	9-88
Exhaust emission control system.....	9-89

## ENGINE COMPARTMENT

■ Gasoline Engine (G 1.2 MPI)

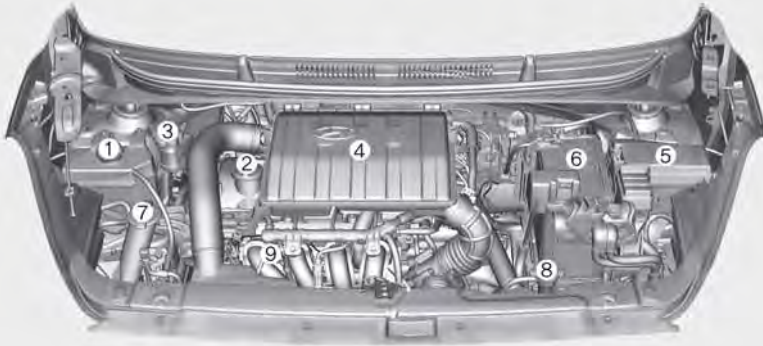

The actual engine room in the vehicle may differ from the illustration.

OAI3089001

- |                                  |                                      |
|----------------------------------|--------------------------------------|
| 1. Engine coolant reservoir      | 6. Battery                           |
| 2. Engine oil filler cap         | 7. Windshield washer fluid reservoir |
| 3. Brake/clutch* fluid reservoir | 8. Radiator cap                      |
| 4. Air cleaner                   | 9. Engine oil dipstick               |
| 5. Fuse box                      |                                      |



## MAINTENANCE SERVICES

You should exercise the utmost care to prevent damage to your vehicle and injury to yourself whenever performing any maintenance or inspection procedures. Inadequate, incomplete or insufficient servicing may result in operational problems with your vehicle that could lead to vehicle damage, an accident, or personal injury.

### Owner's responsibility

#### Information

**Maintenance Service and Record Retention are the owner's responsibility.**

We recommend in general that you have your vehicle serviced by an authorized HYUNDAI dealer.

You should retain documents that show proper maintenance has been performed on your vehicle in accordance with the scheduled maintenance service charts shown on the following pages. You need this information to establish your compliance with the servicing and maintenance requirements of your vehicle warranties.

Detailed warranty information is provided in your Service Passport.

Repairs and adjustments required as a result of improper maintenance or a lack of required maintenance are not covered when your vehicle is covered by warranty.

### Owner maintenance precautions

Improper or incomplete service may result in problems. This chapter gives instructions only for the maintenance items that are easy to perform.

#### Information

**Improper owner maintenance during the warranty period may affect warranty coverage. For details, read the separate Service Passport provided with the vehicle. If you're unsure about any servicing or maintenance procedure, we recommend that the system be serviced by an authorized HYUNDAI dealer.**

#### WARNING

##### Maintenance work

- Performing maintenance work on a vehicle can be dangerous. You can be seriously injured while performing some maintenance procedures. If you lack sufficient knowledge and experience or the proper tools and equipment to do the work, we recommend that the system be serviced by an authorized HYUNDAI dealer.
- Working under the hood with the engine running is dangerous. It becomes even more dangerous when you wear jewelry or loose clothing. These can become entangled in moving parts and result in injury. Therefore, if you must run the engine while working under the hood, make certain that you remove all jewelry (especially rings, bracelets, watches, and necklaces) and all neckties, scarves, and similar loose clothing before getting near the engine or cooling fans.



### WARNING

Do not leave gloves, rags or any other combustible material in the engine compartment. Doing so may cause a heat-induced fire.

### NOTICE

- Do not put heavy objects or apply excessive force on top of the engine cover (if equipped) or fuel related parts.
- When you inspect the fuel system (fuel lines and fuel injection devices), we recommend that you contact an authorized HYUNDAI dealer.
- Do not drive long time with the engine cover (if equipped) removed.
- When checking the engine room, do not go near fire. Fuel, washer fluid, etc., are flammable oils that may cause fire.
- Before touching the battery, ignition cables and electrical wiring, you should disconnect the battery “-” terminal. Otherwise, you may get an electric shock from the electric current.
- When you remove the interior trim cover with a flat head (-) driver, be careful not to damage the cover.
- Be careful when you replace and clean bulbs to avoid burns or electrical shock.

## OWNER MAINTENANCE

The following lists are vehicle checks and inspections that should be performed at the frequencies indicated to help ensure safe, dependable operation of your vehicle.

Any adverse conditions should be brought to the attention of your dealer as soon as possible.

These Owner Maintenance Checks are generally not covered by warranties and you may be charged for labor, parts and lubricants used.

### Owner maintenance schedule

#### *When you stop for fuel:*

- Check the coolant level in coolant reservoir.
- Check the windshield washer fluid level.
- Look for low or under-inflated tires.
- Check the radiator and condenser.

Check if the front of the radiator and condenser are clean and not blocked with leaves, dirt or insects etc.

If any of the above parts are extremely dirty or you are not sure of their condition, we recommend that you contact an authorized HYUNDAI dealer.



#### **WARNING**

**Be careful when checking your engine coolant level if the engine is hot. Scalding hot coolant and steam may blow out under pressure. This could cause burns or other serious injury.**

### ***While operating your vehicle:***

- Note any changes in the sound of the exhaust or any smell of exhaust fumes in the vehicle.
- Check for vibrations in the steering wheel. Notice any increased steering effort or looseness in the steering wheel, or change in its straight-ahead position.
- Notice if your vehicle constantly turns slightly or “pulls” to one side when traveling on smooth, level road.
- When stopping, listen and check for unusual sounds, pulling to one side, increased brake pedal travel or “hard-to-push” brake pedal.
- If any slipping or changes in the operation of your transmission occurs, check the transmission fluid level.
- Check the parking brake.
- Check for fluid leaks under your vehicle (water dripping from the air conditioning system during or after use is normal).

### ***At least monthly:***

- Check the coolant level in the engine coolant reservoir.
- Check the operation of all exterior lights, including the stoplights, turn signals and hazard warning flashers.
- Check the inflation pressures of all tires including the spare for tires that are worn, show uneven wear, or are damaged.
- Check for loose wheel lug nuts.

### ***At least twice a year (for example, every Spring and Fall):***

- Check the radiator, heater and air conditioning hoses for leaks or damage.
- Check the windshield washer spray and wiper operation. Clean wiper blades with clean cloth dampened with washer fluid.
- Check the headlight alignment.
- Check the muffler, exhaust pipes, shields and clamps.
- Check the lap/shoulder belts for wear and function.

### ***At least once a year:***

- Clean the body and door drain holes.
- Lubricate the door hinges and checks, and hood hinges.
- Lubricate the door and hood locks and latches.
- Lubricate the door rubber weatherstrips.
- Check the air conditioning system.
- Inspect and lubricate Automated manual transmission linkage and controls.
- Clean the battery and terminals.
- Check the brake/clutch fluid level.

## SCHEDULED MAINTENANCE SERVICE

- \*1. As it is normal for engine oil to be consumed during driving, the amount of engine oil should be checked regularly. Operating with an insufficient amount of oil can damage the engine, and such damage is not covered by warranty.
- \*2. Check the engine oil level and leak every 500km(350miles) or before starting a long trip.
- \*3. The engine oil change interval for normal operating conditions is based on the use of the recommended engine specification. If the recommended engine oil specification is not used, then replace the engine oil according to the maintenance schedule under severe operating conditions.
- \*4. Inspect for excessive valve noise and/or engine vibration and adjust if necessary. We recommend that an authorized HYUNDAI dealer should perform the operation.
- \*5. When adding coolant, use only deionized water or soft water for your vehicle and never mix hard water in the coolant filled at the factory. An improper coolant mixture can result in serious malfunction or engine damage.
- \*6. Transmission fluid and differential oil should be changed anytime the vehicle has been submerged in water.
- \*7. This maintenance schedule depends on fuel quality. It is applicable only when using a qualified fuel <"EN228 or equivalent">. If there are some important safety matters like fuel flow restriction, surging, loss of power, hard starting problem etc., replace the fuel filter immediately regardless of maintenance schedule. We recommend that you consult an authorized HYUNDAI dealer for details.
- \*8. Inspect drive belt tensioner, idler & alternator pulley, starter & all chassis electrical items. Correct or replace if necessary. For your convenience, it can be replaced prior to it's interval when you do maintenance of other items.
- \*9. For your convenience, it can be replaced prior to it's interval when you do maintenance of other items.

**NORMAL MAINTENANCE SCHEDULE - PETROL ENGINE (CONT.)**

MAINTENANCE INTERVALS	Number of months or driving distance, whichever comes first								
	Years	1	2	3	4	5	6	7	8
Months	2	12	24	36	48	60	72	84	96
Kmsx1,000	1.5	10	20	30	40	50	60	70	80
<b>ENGINE BAY</b>									
Engine oil & filter*1 *2 *3	I	R	R	R	R	R	R	R	R
Drive belt	-	I	I	I	I	I	I	I	I
Air Filter	C	C	C	R	C	C	R	C	C
Battery condition & specific gravity	I	I	I	I	I	I	I	I	I
Spark Plugs*9	Replace at every 60,000 kms								
Valve clearance*4	Inspect at every 90,000 kms or 108 months								
Vacuum Hose	-	-	-	I	-	-	I	-	I
Idler / damper pulley/Adj. Bolt	Inspect when replacing the drive belt or timing belt/chain								
Brake/Clutch fluid	Inspect at every service; Replace at every 40,000 km or 36 months								
Engine Coolant (topup & specify gravity)*5	Replace first at 1,00,000 Km or 60 months; then at every 40,000 Km or 24 months Inspect at every service;								
Manual transaxle fluid*6	No check, No service required								
Automated manual Transmission fluid (if equipped)*6	Inspect at every 60,000 kms or 48 months								

I : Inspect and if necessary adjust, top-up, clean or replace      C : Clean and Replace if necessary      R : Replace

## NORMAL MAINTENANCE SCHEDULE - PETROL ENGINE (CONT.)

MAINTENANCE INTERVALS	Number of months or driving distance, whichever comes first									
	Years	1	2	3	4	5	6	7	8	
MAINTENANCE ITEM	Months	12	24	36	48	60	72	84	96	
	Kmsx1,000	1.5	10	20	30	40	50	60	70	80
<b>VEHICLE ON FLOOR</b>										
Wiper (wiper blade , washer fluid)	I	I	I	I	I	I	I	I	I	I
Brake/Clutch (Pedal free play/Pipes/Hoses/Connectors)	I	I	I	I	I	I	I	I	I	I
Fuel filler cap	-	I	I	I	I	I	I	I	I	I
Climate control air filter	I	C	R	C	R	C	R	C	R	R
Check AC system (refrigerant/Compressor)	I	I	I	I	I	I	I	I	I	I
Cooling system (water pump,hoses) & leakage	I	I	I	I	I	I	I	I	I	I
<b>VEHICLE ON LIFT</b>										
Steering gear rack, linkage and boots	I	I	I	I	I	I	I	I	I	I
Exhaust system	I	I	I	I	I	I	I	I	I	I
Fuel filter*7	-	-	-	I	-	-	R	-	-	-
Front & rear suspension (linkages & ball joints)	-	-	-	-	-	-	-	-	-	-

I : Inspect and if necessary adjust,top-up, clean or replace

C : Clean and Replace if necessary

R : Replace

**NORMAL MAINTENANCE SCHEDULE - PETROL ENGINE (CONT.)**

MAINTENANCE INTERVALS	Number of months or driving distance, whichever comes first								
	Years	1	2	3	4	5	6	7	8
Months	2	12	24	36	48	60	72	84	96
Kmsx1,000	1.5	10	20	30	40	50	60	70	80
Tyre Pressure, condition & rotation	-	I,TR	I,TR	I,TR	I,TR	I,TR	I,TR	I,TR	I,TR
Fuel lines, hoses and connections	-	I	I	I	I	I	I	I	I
Driveshafts & boots	I	I	I	I	I	I	I	I	I
Fluid leakages	I	I	I	I	I	I	I	I	I
Front and rear wheel bearings & bushes	Inspect and if necessary, adjust, clean or replace								
Parking brake (disc/drum ,shoe & operation)	-	C	C	C	C	C	C	C	C
Wheel Alignment & Balancing	-	Inspect and if necessary, adjust							
<b>FINAL CHECKS</b>									
Bolt and nuts on chasis and body	I	I	I	I	I	I	I	I	I
Lubricate locks & hinges	I	L	L	L	L	L	L	L	L
Check all electrical systems (Drive belts ,alternator)*8	-	-	I	I	I	I	I	I	I
Warning lights operation & GDS system check	I	I	I	I	I	I	I	I	I
Ext & int. lights, horn & gauges	I	I	I	I	I	I	I	I	I

I : Inspect and if necessary adjust, top-up, clean or replace

C : Clean and Replace if necessary

R : Replace



## NORMAL MAINTENANCE SCHEDULE - PETROL ENGINE (CONT.)

MAINTENANCE INTERVALS	Number of months or driving distance, whichever comes first								
	Years	1	2	3	4	5	6	7	8
Months	2	12	24	36	48	60	72	84	96
Kmsx1,000	1.5	10	20	30	40	50	60	70	80
Power window	I	I	I	I	I	I	I	I	I
Sunroof operation (if equipped)	-	C	C	C	C	C	C	C	C
All seat belt operation	I	I	I	I	I	I	I	I	I
Road test	-	-	-	I	-	-	-	-	I

I : Inspect and if necessary adjust,top-up, clean or replace

C : Clean and Replace if necessary

R : Replace

### MAINTENANCE UNDER SEVERE USAGE CONDITIONS (PETROL ENGINE)

The following items must be serviced more frequently on cars mainly used under severe driving conditions. Refer to the chart below for the appropriate maintenance intervals.

I : Inspect and if necessary, adjust, correct, clean or replace R : Replace or change

Maintenance item	Maintenance operation	Maintenance intervals	Driving condition
Engine oil and engine oil filter	R	Every 5,000 km (3,000 miles) or 6 months	A, B, C, D, E, F, G, H, I
Air cleaner filter	R	Replace more frequently depending on the condition	C, E
Spark plugs	R	Replace more frequently depending on the condition	A, B, F, G, H, I, K
Manual transmission fluid (if equipped)	R	Every 120,000 km (80,000 miles)	C, D, E, F, G, H, I
Automated manual transmission fluid (if equipped)	R	Every 120,000 km (80,000 miles)	C, D, E, F, G, H, I
Steering gear rack, linkage and boots	I	Inspect more frequently depending on the condition	C, D, E, F, G
Front suspension ball joints	I	Inspect more frequently depending on the condition	C, D, E, F, G

Maintenance item	Maintenance operation	Maintenance intervals	Driving condition
Disc brakes and pads, calipers and rotors	I	Inspect more frequently depending on the condition	C, D, E, G, H
Drum brakes and linings (if equipped)	I	Inspect more frequently depending on the condition	C, D, E, G, H
Parking brake	I	Inspect more frequently depending on the condition	C, D, G, H
Driveshaft and boots	I	Inspect more frequently depending on the condition	C, D, E, F, G, H, I
Climate control air filter	R	Replace more frequently depending on the condition	C, E

#### Severe driving conditions

- A : Repeated short distance driving  
 B : Extensive idling  
 C : Driving in dusty, rough roads  
 D : Driving in areas using salt or other corrosive materials or in very cold weather  
 E : Driving in the condition of inflowing sand or dust into engine  
 F : Driving in heavy traffic area  
 G : Driving in mountainous areas  
 H : Towing a trailer  
 I : Driving over 170 km/h (106 mile/h)

**NORMAL MAINTENANCE SCHEDULE - CNG COMPONENTS**

MAINTENANCE ITEM	MAINTENANCE INTERVALS Km x 1,000									
	1.5	10	20	30	40	50	60	70	80	
All Joints Hoses (Gas Leakage, Damage)	I	I	I	I	I	I	I	I	I	
L P Hose, Coolant Hose (Leakage, Damage)	I	I	I	I	I	I	I	I	I	
All Fastner Torque Values	T	T	T	T	T	T	T	T	T	
CNG gas fuel filter (Gaseous fuel filter)	I	I	R	I	R	I	R	I	R	
Fire Extinguisher	I	I	I	I	I	I	I	I	I	
CNG Cylinder Inspection, Hydro Testing & Certification *1 *3	Hydro Testing & Certification to be done at every 3 years from the date of initial testing by Govt. approved testing agency									

I : Inspect

R : Replace

C : Clean (After Inspection Adjust, Repair, Clean or Replace if necessary)

\*1 : Check with soapy water for leakage at pipe assembly and major parts.

- 1) Vaporizer and inlet/outlet connection
- 2) Injector/fuel delivery pipe assembly and inlet/outlet connection
- 3) Fuel hose connection in the engine room
- 4) Fuel feed line
- 5) Gaseous fuel filter body and inlet/outlet connection
- 6) Multi valve body and feed/return connection
- 7) CNG filling inlet
- 8) Emergency valve body and inlet/outlet connection
- 9) Bombe assembly
- 10) Fuel gauge
- 11) Refuel valve body and connection

\*2 : It is recommended to visit the nearest HYUNDAI Authorised Workshop for draining Tar at every 15,000 km.

\*3 : CNG Fuel Tank has to be tested by Government approved agency at every 5 years.

### EXPLANATION OF SCHEDULED MAINTENANCE ITEMS

#### Engine oil and filter

The engine oil and filter should be changed at the intervals specified in the maintenance schedule. If the car is being driven in severe conditions, more frequent oil and filter changes are required.

#### Drive belts

Inspect all drive belts for evidence of cuts, cracks, excessive wear or oil saturation and replace if necessary. Drive belts should be checked periodically for proper tension and adjusted as necessary.

#### **NOTICE**

**When you are inspecting the belt, place the ignition switch in the LOCK/OFF or ACC position.**

#### Fuel filter

A clogged filter can limit the speed at which the vehicle may be driven, damage the emission system and cause multiple issues such as hard starting. If an excessive amount of foreign matter accumulates in the fuel tank, the filter may require replacement more frequently.

After installing a new filter, run the engine for several minutes, and check for leaks at the connections.

We recommend that the fuel filter be replaced by an authorized HYUNDAI dealer.

#### Fuel lines, fuel hoses and connections

Check the fuel lines, fuel hoses and connections for leakage and damage. We recommend that the fuel lines, fuel hoses and connections be replaced by an authorized HYUNDAI dealer.

#### Vapor hose and fuel filler cap

The vapor hose and fuel filler cap should be inspected at those intervals specified in the maintenance schedule. Make sure that a new vapor hose or fuel filler cap is correctly replaced.

## Vacuum crankcase ventilation hoses (if equipped)

Inspect the surface of hoses for evidence of heat and/or mechanical damage. Hard and brittle rubber, cracking, tears, cuts, abrasions, and excessive swelling indicate deterioration. Particular attention should be paid to examine those hose surfaces nearest to high heat sources, such as the exhaust manifold.

Inspect the hose routing to assure that the hoses do not come in contact with any heat source, sharp edges or moving component which might cause heat damage or mechanical wear. Inspect all hose connections, such as clamps and couplings, to make sure they are secure, and that no leaks are present. Hoses should be replaced immediately if there is any evidence of deterioration or damage.

## Air cleaner filter

We recommend that the air cleaner filter be replaced by an authorized HYUNDAI dealer.

## Spark plugs

Make sure to install new spark plugs of the correct heat range.

When assembling parts, be sure to wipe out foreign substances inside and outside of the boot bottom of the ignition coil and the insulator of the spark plug with a soft cloth to prevent contamination of the spark plug insulator.



## WARNING

**Do not disconnect and inspect spark plugs when the engine is hot. You may burn yourself.**

## Cooling system

Check cooling system components, such as radiator, coolant reservoir, hoses and connections for leakage and damage. Replace any damaged parts.

## Coolant

The coolant should be changed at the intervals specified in the maintenance schedule.

## Manual transmission fluid (if equipped)

Inspect the manual transmission fluid according to the maintenance schedule.

## Automated manual transmission fluid (if equipped)

Inspect the Automated manual transmission fluid according to the maintenance schedule.

### **NOTICE**

The use of non-specified fluid (even marked as compatible with genuine) could result in shift quality deterioration and vibrations, eventually, the transmission failure.

Use only specified Automated manual transmission fluid. (Refer to the "Recommended lubricants and capacities" in chapter 2.)

### Brake hoses and lines

Visually check for proper installation, chafing, cracks, deterioration and any leakage. Replace any deteriorated or damaged parts immediately.

### Brake/clutch fluid (if equipped)

Check brake/clutch fluid level in the brake fluid reservoir. The level should be between "MIN" (Minimum) and "MAX" (Maximum) marks on the side of the reservoir. Use only hydraulic brake/clutch fluid conforming to DOT 4.

### Parking brake

Inspect the parking brake system including the parking brake lever and cables.

### Rear brake drums and linings (if equipped)

Check the rear brake drums and linings for scoring, burning, leaking fluid, broken parts, and excessive wear.

### Brake pads, calipers and discs

Check the pads for excessive wear, discs for run out and wear, and calipers for fluid leakage.

### Suspension mounting bolts

Check the suspension connections for looseness or damage. Retighten to the specified torque.



## Steering gear box, linkage & boots/lower arm ball joint

With the vehicle stopped and engine off, check for excessive free-play in the steering wheel.

Check the linkage for bends or damage. Check the dust boots and ball joints for deterioration, cracks, or damage. Replace any damaged parts.

## Drive shafts and boots

Check the drive shafts, boots and clamps for cracks, deterioration, or damage. Replace any damaged parts and, if necessary, repack the grease.

## Air conditioning refrigerant (if equipped)

Check the air conditioning lines and connections for leakage and damage.

### ENGINE OIL

Engine oil is used for lubricating, cooling, and operating various hydraulic components in the engine. Engine oil consumption while driving is normal, and it is necessary to check and refill the engine oil regularly. Also, check and refill the oil level within the recommended maintenance schedule to prevent deterioration of oil performance.

Check the engine oil following the below procedure.

#### Checking the engine oil level

1. Follow all of the oil manufacturer's precautions.
2. Be sure the vehicle is on the level ground in P (Park) with the parking brake set. if possible, block the wheels.
3. Turn the engine on and warm the engine up until the coolant temperature reaches a constant normal temperature.
4. Turn the engine off, remove the oil filler cap and pull the dipstick out. Wait for 15 minutes for the oil to return to the oil pan.
5. Wipe the dipstick clean and re-insert it fully.

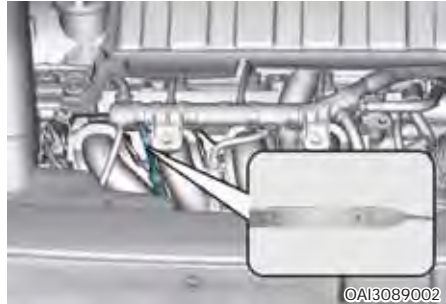

6. Pull the dipstick out again and check the level.

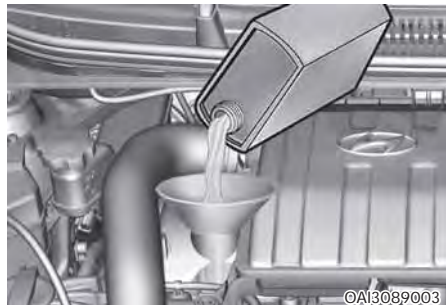

7. If the oil level is below L, add enough oil to bring the level to F (Full). **Do not overfill.**

**Use a funnel to help prevent oil from being spilled on engine components.**

*Use only the specified engine oil. (Refer to the "Recommended lubricants and capacities" in chapter 2.)*

#### **WARNING**

**Radiator hose** Be very careful not to touch the radiator hose when checking or adding the engine oil as it may be hot enough to burn you.

**NOTICE**

To prevent damage to you engine:

- Do not spill engine oil when adding or changing engine oil. Wipe off spilled oil immediately.
- The engine oil consumption may increase while you break in a new vehicle and it will be stabilized after driving 6,000 km (4,000 miles).
- The engine oil consumption can be affected by driving habits, climate conditions, traffic conditions, oil quality, etc. Therefore, it is recommended that you inspect the engine oil level regularly and refill it if necessary.

**Changing the engine oil and filter**

- We recommend that the engine oil and filter be replaced by an authorized HYUNDAI dealer.
- If the maintenance schedule to replace engine oil is exceeded, the engine oil performance may deteriorate, and the engine condition may be affected. Therefore, replace the engine oil according to the maintenance schedule.
- To keep the engine in optimal condition, use the recommended engine oil and filter. If the recommended engine oil and filter are not used replace it according to the maintenance schedule under severe usage conditions.
- The purpose of the maintenance schedule for engine oil replacement is to prevent oil deterioration and it is irrelevant to oil consumption. Check and refill engine oil regularly.



### CAUTION

The engine oil is very hot immediately after the vehicle has been driven and can cause burns during replacement. Replace the engine oil after the engine oil has cooled down.



### WARNING

Used engine oil may cause skin irritation or cancer if left in contact with the skin for prolonged periods of time. Used engine oil contains chemicals that have caused cancer in laboratory animals. Always protect your skin by washing your hands thoroughly with soap and warm water as soon as possible after handling used oil.

## ENGINE COOLANT

The high-pressure cooling system has a reservoir filled with year-round antifreeze coolant. The reservoir is filled at the factory.

Check the antifreeze protection and coolant level at least once a year, at the beginning of the winter season, and before traveling to a colder climate.

### NOTICE

- **Do not drive with no engine coolant. It may cause water pump failure and engine seizure, etc.**
- **When the engine overheats from low engine coolant, suddenly adding engine coolant may cause cracks in the engine. To prevent damage, add engine coolant slowly in small quantities.**

### Checking the coolant level

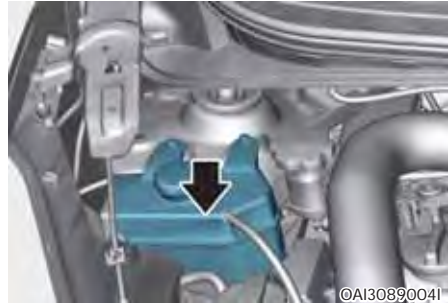

Check the condition and connections of all cooling system hoses and heater hoses. Replace any swollen or deteriorated hoses.

The coolant level should be filled between F (Full) and L (Low) marked on the side of the coolant reservoir when the engine is cool.

If the coolant level is low, add enough distilled (deionized) water.

Bring the level to F (Full), but do not overfill. If frequent additions are required, we recommend that the system be inspected by an authorized HYUNDAI dealer.

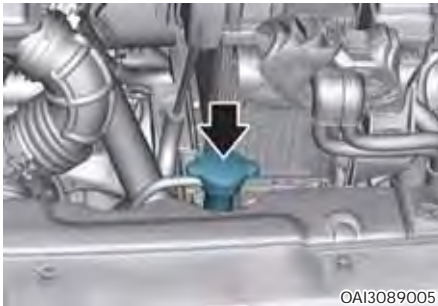

 **WARNING**



Removing radiator cap

- Never attempt to remove the radiator cap while the engine is operating or hot. Doing so might lead to cooling system and engine damage and could result in serious personal injury from escaping hot coolant or steam.

- Turn the engine off and wait until it cools down. Use extreme care when removing the radiator cap. Wrap a thick towel around it, and turn it counterclockwise slowly to the first stop. Step back while the pressure is released from the cooling system. When you are sure all the pressure has been released, press down on the cap, using a thick towel, and continue turning counterclockwise to remove it.
- Even if the engine is not operating, do not remove the radiator cap or the drain plug while the engine and radiator are hot. Hot coolant and steam may still blow out under pressure, causing serious injury.

 **WARNING**



The electric motor (cooling fan) is controlled by engine coolant temperature, refrigerant pressure and vehicle speed. It may sometimes operate even when the engine is not running. Use extreme caution when working near the blades of the cooling fan so that you are not injured by a rotating fan blades. As the engine coolant temperature decreases, the electric motor will automatically shut off. This is a normal condition.

## Recommended engine coolant

- Use only soft (distilled) water in the coolant mixture.
- The engine in your vehicle has aluminum engine parts and must be protected by an ethylene-glycol-based coolant to prevent corrosion and freezing.
- DO NOT USE alcohol or methanol coolant or mix them with the specified coolant.
- Do not use a solution that contains more than 60% antifreeze or less than 35% antifreeze, which would reduce the effectiveness of the solution.

For mixture percentage, refer to the following table.

Ambient Temperature	Mixture Percentage (volume)	
	Antifreeze	Water
-15 °C (5 °F)	35	65
-25 °C (-13 °F)	40	60
-35 °C (-31 °F)	50	50
-45 °C (-49 °F)	60	40

### WARNING



#### Radiator cap

Do not remove the radiator cap when the engine and radiator are hot. Scalding hot coolant and steam may blow out under pressure causing serious injury.

## Changing the coolant

We recommend that the coolant be replaced by an authorized HYUNDAI dealer.

### **NOTICE**

Put a thick cloth or fabric around the radiator cap before refilling the coolant in order to prevent the coolant from overflowing into engine parts such as the alternator.

### WARNING

#### Coolant

- Do not use radiator coolant or antifreeze in the washer fluid reservoir.
- Radiator coolant can severely obscure visibility when sprayed on the windshield and may cause loss of vehicle control or damage to paint and body trim.

## BRAKE/CLUTCH (IF EQUIPPED) FLUID

### Checking the brake/clutch fluid level

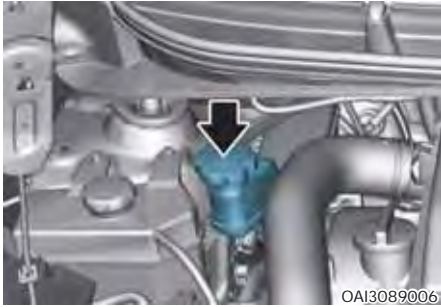

Check the fluid level in the reservoir periodically. The fluid level should be between MAX (Maximum) and MIN (Minimum) marks on the side of the reservoir.

Before removing the reservoir cap and adding the brake/clutch fluid, clean the area around the reservoir cap thoroughly to prevent brake/clutch fluid contamination. If the level is low, add the fluid to the MAX (Maximum) level. The level will fall with accumulated mileage. This is a normal condition associated with the wear of the brake linings and/or clutch disc (if equipped).

If the fluid level is excessively low, we recommend that the system be checked by an authorized HYUNDAI dealer.

*Use only the specified brake/clutch fluid.  
(Refer to "Recommended lubricants or capacities" in chapter 2.)*

*Never mix different types of fluid.*

#### **WARNING**

Loss of brake fluid

In the event the brake system requires frequent additions of fluid, we recommend that the system be inspected by an authorized HYUNDAI dealer.

#### **Information**

Before removing the brake/clutch filter cap, read the warning on the cap.

#### **WARNING**

Clean the filler cap before removing. Use only DOT 4 brake/clutch fluid from a sealed container.



**WARNING****Brake/clutch fluid**

When changing and adding the brake/clutch fluid, handle it carefully. Do not let it come in contact with your eyes. If the brake/clutch fluid come in contact with your eyes, immediately flush them with a large quantity of fresh tap water. Have your eyes examined by a doctor as soon as possible.

**NOTICE**

- Do not allow the brake/clutch fluid to contact the vehicle's body paint, as it will result in paint damage.
- NEVER use brake/clutch fluid which have been exposed to open air for an extended time, as its quality cannot be guaranteed. It should be properly disposed.
- Don't put in the wrong kind of fluid. A few drops of mineral-based oil in your brake/clutch system can damage brake/clutch system parts.

## WASHER FLUID

### Checking the washer fluid level



Check the fluid level in the washer fluid reservoir and add fluid if necessary. Plain water may be used if washer fluid is not available.

However, use washer solvent with antifreeze characteristics in cold climates to prevent freezing.

### WARNING

#### Coolant

- Do not use radiator coolant or antifreeze in the washer fluid reservoir.
- Radiator coolant can severely obscure visibility when sprayed on the windshield and may cause loss of vehicle control or damage to the paint and body trim.
- Windshield washer fluid agents contain some amounts of alcohol and can be flammable under certain circumstances. Do not allow sparks or flame come in contact with the washer fluid or the washer fluid reservoir. Damage to the vehicle or occupants could occur.
- Windshield washer fluid is poisonous to humans and animals. Do not drink and avoid coming in contact with the windshield washer fluid. Serious injury or death could occur.

## PARKING BRAKE

### Checking the parking brake



OAI3069006

Check the stroke of the parking brake by counting the number of "clicks" heard while fully applying it from the released position.

Also, the parking brake alone should securely hold the vehicle on a fairly steep grade. If the stroke is more or less than specified, we recommend that the system be inspected by an authorized HYUNDAI dealer.

**Stroke : 5-7 "clicks" at a force of 20 kg  
(44 lbs, 196 N).**

## AIR CLEANER

### Filter replacement

The air cleaner filter can be cleaned for inspection using compressed air.

Do not attempt to wash or to rinse it. Otherwise, water will damage the filter.

If soiled, the air cleaner filter must be replaced.



1. Loosen the hose clamp and remove hose from cleaner.
2. Open the cleaner cover by opening the clips.



3. Remove the used filter and wipe the inside of the air cleaner housing carefully not to remain dusts in cover housing.
4. Place the new filter with clean hands and ensure the rubber gasket is not taken off.
5. Reassemble in the reverse order of removal.

## Information

If the vehicle is operated in extremely dusty or sandy areas, replace the element more often than the usual recommended intervals (refer to “Maintenance Under Severe Usage Conditions” in this chapter).

### **NOTICE**

- Do not drive with the air cleaner filter removed. This will result in excessive engine wear.
- When removing the air cleaner filter after loosening the hose be careful that dust or dirt does not enter the air intake hose or engine side, or else damage may result.
- Use HYUNDAI genuine parts or the equivalent specified for your vehicle. Use of non-genuine parts could damage the air flow sensor.

## CLIMATE CONTROL AIR FILTER

### Filter inspection

If the vehicle is operated in the severely air-polluted cities or on dusty rough roads for a long period, it should be inspected more frequently and replaced earlier. When you, the owner, replace the climate control air filter, replace it performing the following procedure, and be careful to avoid damaging other components.

Replace the filter according to the maintenance Schedule.

### Filter replacement



1. Open the glove box.

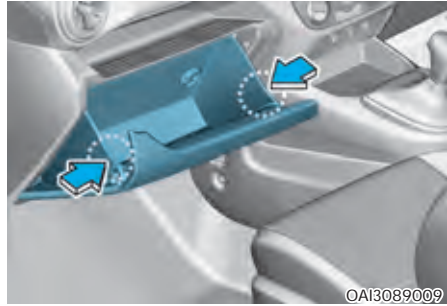

2. Push in both sides of the glove box as shown. This will ensure that the glove box stopper pins will get released from its holding location allowing the glove box to hang.



3. Remove the climate control air filter cover.



4. Clean the climate control air filter.
5. Reassemble in the reverse order of disassembly.

**NOTICE**

Install a new climate control air filter in the correct direction with the arrow symbol (↓) facing downwards.

Otherwise, the climate control effects may decrease, possibly with a noise.

## WIPER BLADES

### Blade inspection

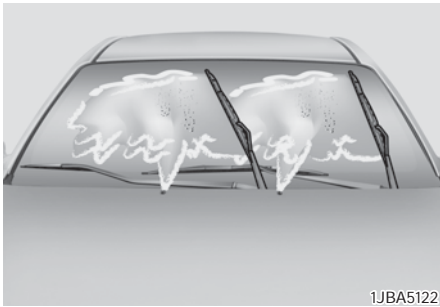

1JBA5122

#### **i** Information

**Commercial hot waxes applied by automatic car washes have been known to make the windshield difficult to clean.**

Contamination of either the windshield or the wiper blades with foreign matter can reduce the effectiveness of the windshield wipers. Common sources of contamination are insects, tree sap, and hot wax treatments used by some commercial car washes. If the blades are not wiping properly, clean both the window and the blades with a good cleaner or mild detergent, and rinse thoroughly with clean water.

#### **NOTICE**

**To prevent damage to the wiper blades, do not use gasoline, kerosene, paint thinner, or other solvents on or near them.**

### Blade replacement

When the wipers no longer clean adequately, the blades may be worn or cracked, and require replacement.

#### **NOTICE**

**To prevent damage to the wiper arms or other components, do not attempt to move the wipers manually.**

#### **NOTICE**

**The use of a non-specified wiper blade could result in wiper malfunction and failure.**



### Front windshield wiper blade



OLMB073020

1. Raise the wiper arm and turn the wiper blade assembly to expose the plastic locking clip.

#### **NOTICE**

Do not allow the wiper arm to fall against the windshield, since it may chip or crack the windshield.



OLMB073021



OLMB073022

2. Compress the clip and slide the blade assembly downward.
3. Lift it off the arm.
4. Install the blade assembly in the reverse order of removal.

**Rear window wiper blade  
(if equipped)**



1. Raise the wiper arm and rotate the wiper blade assembly (1).
2. Pull out the wiper blade assembly.



3. Install the new blade assembly by inserting the center part into the slot in the wiper arm until it clicks into place.
4. Make sure the blade assembly is installed firmly by trying to pull it slightly.

To prevent damage to the wiper arms or other components, we recommend that the wiper blade be replaced by an authorized HYUNDAI dealer.

## BATTERY

### For best battery service

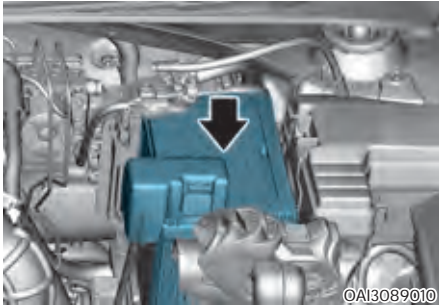

- Keep the battery securely mounted.
- Keep the battery top clean and dry.
- Keep the terminals and connections clean, tight, and coated with petroleum jelly or terminal grease.
- Rinse any spilled electrolyte from the battery immediately with a solution of water and baking soda.
- If the vehicle is not going to be used for an extended time, disconnect the negative terminal cable of the battery to prevent discharge.

**i** Information - For batteries marked with UPPER and LOWER



**If your vehicle is equipped with a battery marked with LOWER (MIN) and UPPER (MAX) on the side, you should check the electrolyte level.**

**The electrolyte level should be between LOWER (MIN) and UPPER (MAX).**

**Be careful not to spill distilled (or de-mineralized) water over the battery surface or other adjacent components.**

**Also, do not overfill the battery cells.**

**If not, it may corrode the battery or other components. Finally, securely close the cell cap. However, we recommend you to contact an authorized HYUNDAI dealer for better battery service.**

### **NOTICE**

**If the Electrolyte level is Low, add distilled (or demineralized) water. Never add sulfuric acid or other electrolyte.**

 **WARNING**

**Battery dangers**



Always read the following instructions carefully when handling a battery.



Keep lighted cigarettes and all other flames or sparks away from the battery.



Hydrogen, a highly combustible gas, is always present in battery cells and may explode if ignited.



Keep batteries out of the reach of children because batteries contain highly corrosive **SULFURIC ACID**. Do not allow battery acid to contact your skin, eyes, clothing or paint finish.



If any electrolyte gets into your eyes, flush your eyes with clean water for at least 15 minutes and get immediate medical attention. If electrolyte gets on your skin, thoroughly wash the contacted area. If you feel a pain or a burning sensation, get medical attention immediately.



Wear eye protection when charging or working near a battery. Always provide ventilation when working in an enclosed space.

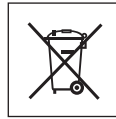

An inappropriately disposed battery can be harmful to the environment and human health. Dispose the battery according to your local law(s) or regulation.



The battery contains lead. Do not dispose of it after use. Please return the battery to an authorized **HYUNDAI** dealer to be recycled.

- When lifting a plastic-cased battery, excessive pressure on the case may cause battery acid to leak, resulting in personal injury. Lift with a battery carrier or with your hands on opposite corners.
- Never attempt to recharge the battery when the battery cables are connected.
- The electrical ignition system works with high voltage. Never touch these components with the engine running or the ignition switched on.

Failure to follow the above warnings can result in serious bodily injury or death.

**NOTICE**

If you connect unauthorized electronic devices to the battery, the battery may be discharged. Never use unauthorized devices.

**WARNING**

Always follow these instructions when handling your vehicle's battery to prevent damage to your battery:

- When you do not use the vehicle for a long time in a low temperature area, disconnect the battery and keep it indoors.
- Always charge the battery fully to prevent battery case damage in low temperature areas.
- Prevent liquid from wetting the battery terminals. The performance of the battery may be degraded, and may cause injury. Be cautious when loading liquid in the trunk.
- Do not tilt the battery.
- If you connect unauthorized electronic devices to the battery, the battery may be discharged. Never use unauthorized devices.

**Battery capacity label**

■ Example



OAI3093012L

✧ The actual battery label in the vehicle may differ from the illustration.

1. CMF45L-DIN : The HYUNDAI model name of battery
2. 12V : The nominal voltage
3. 45Ah(20HR) : The nominal capacity (in Ampere hours)
4. RC 80min : The nominal reserve capacity (in min.)
5. CCA410 : The cold-test current in amperes by SAE
6. 410A : The cold-test current in amperes by EN

### Battery recharging

Your vehicle has a maintenance-free, calcium-based battery.

- If the battery becomes discharged in a short time (because, for example, the headlights or interior lights were left on while the vehicle was not in use), recharge it by slow charging (trickle) for 10 hours.
- If the battery gradually discharges because of high electric load while the vehicle is being used, recharge it at 20-30A for two hours.



#### WARNING

##### Recharging battery

When recharging the battery, observe the following precautions:

- The battery must be removed from the vehicle and placed in an area with good ventilation.
- Do not allow cigarettes, sparks, or flame near the battery.
- Watch the battery during charging, and stop or reduce the charging rate if the battery cells begin gassing (boiling) violently or if the temperature of the electrolyte of any cell exceeds 49°C (120°F).
- Wear eye protection when checking the battery during charging.
- Disconnect the battery charger in the following order.
  1. Turn off the battery charger main switch.
  2. Unhook the negative clamp from the negative battery terminal.
  3. Unhook the positive clamp from the positive battery terminal.



#### WARNING

- Before performing maintenance or recharging the battery, turn off all accessories and stop the engine.
- The negative battery cable must be removed first and installed last when the battery is disconnected.

### Reset items

Items should be reset after the battery has been discharged or the battery has been disconnected.

- Auto up/down window (See chapter 5)
- Climate control system (See chapter 5)
- Audio (See chapter 5)

### Battery replacement

Replacing a Battery required precautionary measures.

We recommend that you consult an authorized HYUNDAI dealer.

#### NOTICE

Make sure the battery is installed securely when the it is replaced.

If the battery vibrates while driving, the case and electrode plate can be damaged.

## TIRES AND WHEELS

### Tire care

For proper maintenance, safety and maximum fuel economy, you must always maintain recommended tire inflation pressures and stay within the load limits and weight distribution recommended for your vehicle.

### Recommended cold tire inflation pressures

All tire pressures (including the spare) should be checked when the tires are cold. "Cold Tires" means the vehicle has not been driven for at least three hours or driven less than 1.6 km (one mile).

Recommended pressures must be maintained for the best ride, top vehicle handling, and minimum tire wear.

For recommended inflation pressure, refer to "Tire and wheels" in chapter 2.



All specifications (sizes and pressures) can be found on a label attached to the driver's side center pillar.

### WARNING

#### Tire underinflation

Severe underinflation (70 kPa (10 psi) or more) can lead to severe heat build-up, causing blowouts, tread separation and other tire failures that can result in the loss of vehicle control leading to severe injury or death. This risk is much higher on hot days and when driving for long periods at high speeds.

### NOTICE

- Underinflation also results in excessive wear, poor handling and reduced fuel economy. Wheel deformation also is possible. Keep your tire pressures at the proper levels. If a tire frequently needs refilling, we recommend that the system be checked by an authorized HYUNDAI dealer.
- Overinflation produces a harsh ride, excessive wear at the center of the tire tread, and a greater possibility of damage from road hazards.

### NOTICE

- Warm tires normally exceed recommended cold tire pressures by 28 to 41 kPa (4 to 6 psi). Do not release air from warm tires to adjust the pressure or the tires will be underinflated.
- Be sure to reinstall the tire inflation valve caps. Without the valve cap, dirt or moisture could get into the valve core and cause air leakage. If a valve cap is missing, install a new one as soon as possible.



## WARNING

### Tire Inflation

Overinflation or underinflation can reduce tire life, adversely affect vehicle handling, and lead to sudden tire failure. This could result in loss of vehicle control and potential injury.

## NOTICE

### Tire pressure

Always observe the following:

- Check tire pressure when the tires are cold. (After vehicle has been parked for at least three hours or hasn't been driven more than 1.6 km (one mile) since startup.)
- Check the pressure of your spare tire each time you check the pressure of other tires.
- Never overload your vehicle. Be careful not to overload a vehicle luggage rack if your vehicle is equipped with one.
- Worn, old tires can cause accidents. If your tread is badly worn, or if your tires have been damaged, replace them.

## Checking tire inflation pressure

Check your tires once a month or more. Also, check the tire pressure of the spare tire.

### *How to check*

Use a good quality gage to check tire pressure. You can not tell if your tires are properly inflated simply by looking at them. Radial tires may look properly inflated even when they're underinflated.

Check the tire's inflation pressure when the tires are cold. - "Cold" means your vehicle has been sitting for at least three hours or driven no more than 1.6 km (1 mile).

Remove the valve cap from the tire valve stem. Press the tire gage firmly onto the valve to get a pressure measurement. If the cold tire inflation pressure matches the recommended pressure on the tire and loading information label, no further adjustment is necessary. If the pressure is low, add air until you reach the recommended amount.

If you overfill the tire, release air by pushing on the metal stem in the center of the tire valve. Recheck the tire pressure with the tire gage. Be sure to put the valve caps back on the valve stems. They help prevent leaks by keeping out dirt and moisture.





## WARNING

- Inspect your tires frequently for proper inflation as well as wear and damage. Always use a tire pressure gauge.
- Tires with too much or too little pressure wear unevenly causing poor handling, loss of vehicle control, and sudden tire failure leading to accidents, injuries, and even death. The recommended cold tire pressure for your vehicle can be found in this manual and on the tire label located on the driver's side center pillar.
- Worn tires can cause accidents. Replace tires that are worn, show uneven wear, or are damaged.
- Remember to check the pressure of your spare tire. HYUNDAI recommends that you check the spare every time you check the pressure of the other tires on your vehicle.

## Tire rotation

To equalize tread wear, it is recommended that the tires be rotated according to the maintenance schedule or sooner if irregular wear develops.

During rotation, check the tires for correct balance.

When rotating tires, check for uneven wear and damage. Abnormal wear is usually caused by incorrect tire pressure, improper wheel alignment, out-of-balance wheels, severe braking or severe cornering. Look for bumps or bulges in the tread or side of tire. Replace the tire if you find either of these conditions. Replace the tire if fabric or cord is visible. After rotation, be sure to bring the front and rear tire pressures to specification and check lug nut tightness.

Refer to "Tire and wheels" in chapter 2.

### ■ With a full-size spare tire (if equipped)

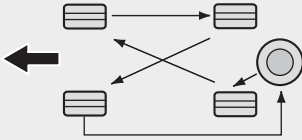

CBGQ0706

### ■ Without a spare tire

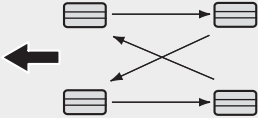

CBGQ0707

### ■ Directional tires (if equipped)

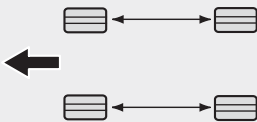

CBGQ0707A

Disc brake pads should be inspected for wear whenever tires are rotated.

### **i** Information

**Rotate radial tires that have an asymmetric tread pattern only from front to rear and not from right to left.**

### **⚠** WARNING

- Do not use the compact spare tire for tire rotation.
- Do not mix bias ply and radial ply tires under any circumstances. This may cause unusual handling characteristics that could result in death, severe injury or property damage.

## Wheel alignment and tire balance

The wheels on your vehicle were aligned and balanced carefully at the factory to give you the longest tire life and best overall performance.

In most cases, you will not need to have your wheels aligned again. However, if you notice unusual tire wear or your vehicle pulling one way or the other, the alignment may need to be reset.

If you notice your vehicle vibrating when driving on a smooth road, your wheels may need to be rebalanced.

### **NOTICE**

**Improper wheel weights can damage your vehicle's aluminum wheels. Use only approved wheel weights.**

## Tire replacement



If the tire is worn evenly, a tread wear indicator will appear as a solid band across the tread. This shows there is less than 1.6 mm (1/16 inch) of tread left on the tire. Replace the tire when this happens.

Do not wait for the band to appear across the entire tread before replacing the tire.

### NOTICE

When replacing the tires, recheck and tighten the wheel nuts after driving about 1,000 km (620 miles). If the steering wheel shakes or the vehicle vibrates while driving, the tire might be out of balance so align the tire balance. If the problem is not solved, we recommend that you contact an authorized HYUNDAI dealer.

### ⚠ WARNING

#### Replacing tires

To reduce the chance of serious or fatal injuries from an accident caused by tire failure or loss of vehicle control:

- Replace tires that are worn, show uneven wear, or are damaged. Worn tires can cause loss of braking effectiveness, steering control, and traction.
- Do not drive your vehicle with too little or too much pressure in your tires. This can lead to uneven wear and tire failure.
- When replacing tires, never mix radial and bias-ply tires on the same car. You must replace all tires (including the spare) if moving from radial to bias-ply tires.
- It is best to replace all four tires at the same time. If that is not possible, or necessary, then replace the two front or two rear tires as a pair. Replacing just one tire can seriously affect your vehicle's handling.
- Using tires and wheels other than the recommended sizes could cause unusual handling characteristics and poor vehicle control, resulting in a serious accident.
- Wheels that do not meet HYUNDAI's specifications may fit poorly and result in damage to the vehicle or unusual handling and poor vehicle control.
- The works by comparing the speed of the wheels. Tire size can affect wheel speed. When replacing tires, all 4 tires must use the same size originally supplied with the vehicle. Using tires of a different size can cause the ABS (Anti-lock Brake System) and ESC (Electronic Stability Control) to work irregularly. (if equipped)

### ***Compact spare tire replacement (if equipped)***

A compact spare tire has a shorter tread life than a regular size tire. Replace it when you can see the tread wear indicator bars on the tire. The replaced compact spare tire should be the same size and design tire as the one provided with your new vehicle and should be mounted on the same compact spare tire wheel. The compact spare tire is not designed to be mounted on a regular size wheel, and the compact spare tire wheel is not designed to mount a regular size tire.

### **Wheel replacement**

When replacing the metal wheels for any reason, make sure the new wheels are equivalent to the original factory units in diameter, rim width and offset.

#### **WARNING**

**A wheel that is not the correct size may adversely affect wheel and bearing life, braking and stopping abilities, handling characteristics, ground clearance, body-to-tire clearance, snow chain clearance, speedometer and odometer calibration, headlight aim and bumper height.**

### **Tire traction**

Tire traction can be reduced if you drive on worn tires, tires that are improperly inflated or on slippery road surfaces. Tires should be replaced when tread wear indicators appear. Slow down whenever there is rain, snow or ice on the road, to reduce the possibility of losing control of the vehicle.

## Tire maintenance

In addition to proper inflation, correct wheel alignment helps decrease tire wear. If you find a tire worn unevenly, have your dealer check the wheel alignment.

When you have new tires installed, make sure they are balanced. This will increase vehicle ride comfort and tire life. Additionally, a tire should always be rebalanced if it is removed from the wheel.

## Tire sidewall labeling

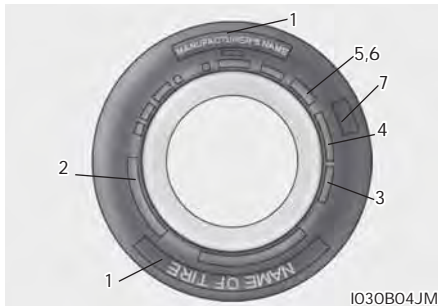

This information identifies and describes the fundamental characteristics of the tire and also provides the tire identification number (TIN) for safety standard certification. The TIN can be used to identify the tire in case of a recall.

### 1. Manufacturer or brand name

Manufacturer or Brand name is shown.

### 2. Tire size designation

A tire's sidewall is marked with a tire size designation. You will need this information when selecting replacement tires for your car. The following explains what the letters and numbers in the tire size designation mean.

Example of tire size designation:

(These numbers are provided as an example only; your tire size designator could vary depending on your vehicle.)

**165/70R14 81T**

165 - Tire width in millimeters.

70 - Aspect ratio. The tire's chapter height as a percentage of its width.

R - Tire construction code (Radial).

14 - Rim diameter in inches.

81 - Load Index, a numerical code associated with the maximum load the tire can carry.

T - Speed Rating Symbol. See the speed rating chart in this chapter for additional information.

### Wheel size designation

Wheels are also marked with important information that you need if you ever have to replace one. The following explains what the letters and numbers in the wheel size designation mean.

Example wheel size designation:

**5.0JX14**

5.0 - Rim width in inches.

J - Rim contour designation.

14 - Rim diameter in inches

### Tire speed ratings

The chart below lists many of the different speed ratings currently being used for passenger car tires. The speed rating is part of the tire size designation on the sidewall of the tire. This symbol corresponds to that tire's designed maximum safe operating speed.

Speed Rating Symbol	Maximum Speed
S	180 km/h (112 mph)
T	190 km/h (118 mph)
H	210 km/h (130 mph)
V	240 km/h (149 mph)
W	270 km/h (168 mph)
Y	300 km/h (186 mph)

### 3. Checking tire life (TIN : Tire Identification Number)

Any tires that are over 6 years old, based on the manufacturing date, (including the spare tire) should be replaced by new ones. You can find the manufacturing date on the tire sidewall (possibly on the inside of the wheel), displaying the DOT Code. The DOT Code is a series of numbers on a tire consisting of numbers and English letters. The manufacturing date is designated by the last four digits (characters) of the DOT code.

**DOT : XXXX XXXX 0000**

The front part of the DOT means a plant code number, tire size and tread pattern and the last four numbers indicate week and year manufactured.

For example:

DOT XXXX XXXX 2223 represents that the tire was produced in the 22th week of 2023.

### WARNING

**Tire age**

**Tires degrade over time, even when they are not being used.**

**Regardless of the remaining tread, it is recommended that tires generally be replaced after six (6) years of normal service. Heat caused by hot climates or frequent high loading conditions can accelerate the aging process. Failure to follow this warning could cause sudden tire failure, which could lead to a loss of control and an accident involving serious injury or death.**

#### ***4. Tire ply composition and material***

The number of layers or plies of rubber-coated fabric in the tire. Tire manufacturers also must indicate the materials in the tire, which include steel, nylon, polyester, and others. The letter “R” means radial ply construction; the letter “D” means diagonal or bias ply construction; and the letter “B” means belted-bias ply construction.

#### ***5. Maximum permissible inflation pressure***

This number is the greatest amount of air pressure that should be put in the tire. Do not exceed the maximum permissible inflation pressure. Refer to the Tire and Loading Information label for recommended inflation pressure.

#### ***6. Maximum load rating***

This number indicates the maximum load in kilograms and pounds that can be carried by the tire. When replacing the tires on the vehicle, always use a tire that has the same load rating as the factory installed tire.

#### ***7. Uniform tire quality grading***

Quality grades can be found where applicable on the tire sidewall between tread shoulder and maximum chapter width.

For example:

TREAD wear 200

TRACTION AA

TEMPERATURE A

#### **Tread wear**

The tread wear grade is a comparative rating based on the wear rate of the tire when tested under controlled conditions on a specified government test course. For example, a tire graded 150 would wear one-and-a-half times (1½) as well on the government course as a tire graded 100.

The relative performance of tires depends upon the actual conditions of their use, however, and may depart significantly from the norm due to variations in driving habits, service practices and differences in road characteristics and climate.

These grades are molded on the sidewalls of passenger vehicle tires. The tires available as standard or optional equipment on your vehicle may vary with respect to grade.

### Traction - AA, A, B & C

The traction grades, from highest to lowest, are AA, A, B and C. Those grades represent the tire's ability to stop on wet pavement measured under controlled conditions on specified government test surfaces of asphalt and concrete. A tire marked C may have poor traction performance.



### WARNING

The traction grade assigned to this tire is based on straight-ahead braking traction tests, and does not include acceleration, cornering, hydroplaning, or peak traction characteristics.

### Temperature -A, B & C

The temperature grades are A (the highest), B, and C, representing the tire's resistance to the generation of heat and its ability to dissipate heat when tested under controlled conditions on a specified indoor laboratory test wheel.

Sustained high temperature can cause the material of the tire to degenerate and reduce tire life, and excessive temperature can lead to sudden tire failure. Grades B and A represent higher levels of performance on the laboratory test wheel than the minimum required by law.



### WARNING

#### Tire temperature

The temperature grade for this tire is established for a tire that is properly inflated and not overloaded. Excessive speed, underinflation or excessive loading, either separately or in combination, can cause heat build-up and sudden tire failure. This can cause loss of vehicle control and serious injury or death.

#### Low aspect ratio tire (if equipped)

Low aspect ratio tires, whose aspect ratio is lower than 50, are provided for sporty looks.

Because the low aspect ratio tires are optimized for handling and braking, it may be more uncomfortable to ride in and there is more noise compare with normal tires.



**NOTICE**

Because the sidewall of the low aspect ratio tire is shorter than the normal, the wheel and tire of the low aspect ratio tire is easier to be damaged. So, follow the instructions below.

- When driving on a rough road or off road, drive cautiously because tires and wheels may be damaged. And after driving, inspect tires and wheels.
- When passing over a pothole, speed bump, manhole, or curb stone, drive slowly so that the tires and wheels are not damaged.
- If the tire is impacted, we recommend that you inspect the tire condition or contact an authorized HYUNDAI dealer.
- To prevent damage to the tire, inspect the tire condition and pressure every 3,000 km (1,864 miles).

**NOTICE**

- It is not easy to recognize the tire damage with your own eyes. But, if there is the slightest hint of tire damage, even though you cannot see the tire damage with your own eyes, have the tire checked or replaced because the tire damage may cause air leakage from the tire.
- If the tire is damaged by driving on a rough road, off road, pothole, manhole, or curb stone, it will not be covered by the warranty.
- You can find out the tire information on the tire sidewall.

## FUSES

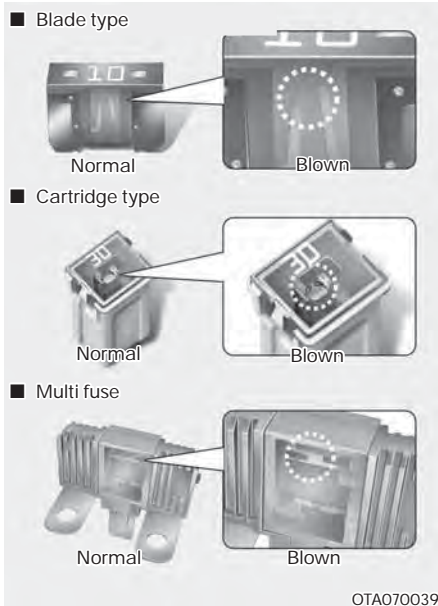

A vehicle's electrical system is protected from electrical overload damage by fuses.

This vehicle has 2 fuse panels, one located in the driver's side panel bolster, the other in the engine compartment.

If any of your vehicle's lights, accessories or controls do not work, check the appropriate circuit fuse. If a fuse has blown, the element inside the fuse will be melted or broken.

If the electrical system does not work, first check the driver's side fuse panel. Before replacing a blown fuse, turn the engine and all switches off, and then disconnect the negative battery cable. Always replace a blown fuse with one of the same rating.

If the replacement fuse blows, this indicates an electrical problem. Avoid using the system involved and we recommend that all inspect an authorized HYUNDAI dealer.

### **i** Information

**Three kinds of fuses are used: blade type for lower amperage rating, cartridge type, and multi fuse for higher amperage ratings.**

### **⚠** WARNING

**NEVER** replace a fuse with anything but another fuse of the same rating.

- A higher capacity fuse could cause damage and possibly cause a fire.
- Do not install a wire or aluminum foil instead of the proper fuse - even as a temporary repair. It may cause extensive wiring damage and possibly a fire.

### **NOTICE**

Do not use a screwdriver or any other metal object to remove fuses because it may cause a short circuit and damage the system.

### **i** Information

**The actual fuse/relay panel label may differ from equipped items.**

**NOTICE**

- When replacing a blown fuse or relay with a new one, make sure the new fuse or relay fits tightly into the clips. The incomplete fastening fuse or relay may cause the vehicle wiring and electric systems damage and a possible fire.
- Do not remove fuses, relays and terminals fastened with bolts or nuts. The fuses, relays and terminals may be fastened incompletely, and it may cause a possible fire. If fuses, relays and terminals fastened with bolts or nuts are blown, consult an authorized HYUNDAI dealer.
- Do not input any other objects except fuses or relays into fuse/relay terminals such as a driver or wiring. It may cause contact failure and system malfunction.
- Check the blown fuse with checking the fuse information on the fuse box cover.
- Replace the blown fuse on the safe place after turning off the ignition switch and all electric switches and disconnecting the negative battery cable.

**Instrument panel fuse replacement**

1. Turn the vehicle off.
2. Turn all other switches OFF.
3. Open the fuse panel cover.
4. Refer to the label on the inside of the fuse panel cover to locate the suspected fuse location.

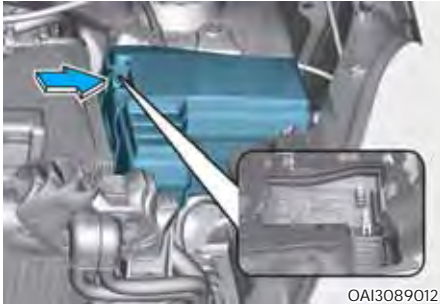

5. Pull the suspected fuse straight out. Use the removal tool provided in the engine compartment fuses panel cover.
6. Check the removed fuse; replace it if it is blown. Spare fuses are provided in the instrument panel fuse panels (or in the engine compartment fuse panel).
7. Push in a new fuse of the same rating, and make sure it fits tightly in the clips. If it fits loosely, we recommend that you consult an authorized HYUNDAI dealer.

In an emergency, if you do not have a spare fuse, use a fuse of the same rating from a circuit you may not need for operating the vehicle, such as the cigarette lighter fuse.

If the headlights or other electrical components do not work and the fuses are undamaged, check the fuse panel in the engine compartment. If a fuse is blown, it must be replaced with the same rating.

### Memory fuse

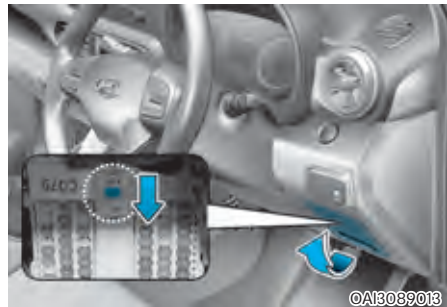

Your vehicle is equipped with the memory fuse to prevent battery discharge if your vehicle is parked without being operated for prolonged periods. Use the following procedures before parking the vehicle for prolonged periods.

1. Turn off the engine.
2. Turn off the headlights and tail lights.
3. Open the driver's side panel cover and pull up the memory fuse.

### Information

- **If the memory fuse is pulled up from the fuse panel, the warning chime, audio, clock and interior lamps, etc., will not operate. Some items must be reset after replacement. Refer to "Battery" in this chapter.**
- **Even though the memory fuse is pulled up, the battery can still be discharged by operation of the headlights or other electrical devices.**

## Engine compartment panel fuse replacement

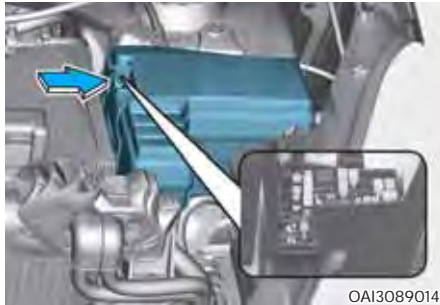

1. Turn the vehicle off.
2. Turn all other switches OFF.
3. Remove the fuse panel cover by pressing the tab and pulling up.
4. Check the removed fuse; replace it if it is blown. To remove or insert the fuse, use the removal tool in the engine compartment fuse panel.
5. Push in a new fuse of the same rating, and make sure it fits tightly in the clips. If it fits loosely, we recommend that you consult an authorized HYUNDAI dealer.

### NOTICE

After checking the fuse panel in the engine compartment, securely install the fuse panel cover. You may hear a clicking sound if the cover is securely latched. If it is not securely latched, electrical failure may occur from water contact.

## Multi fuse (Main fuse)

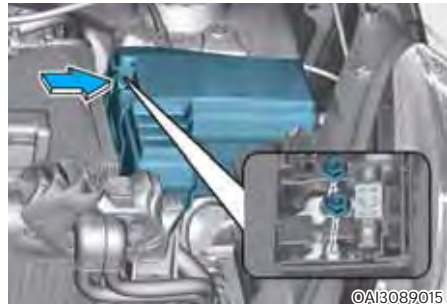
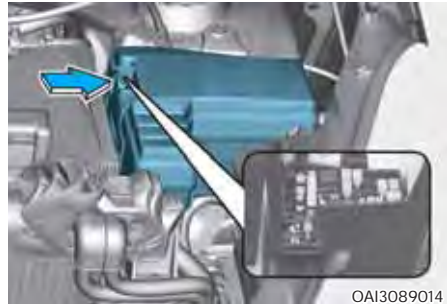

If the multi fuse is blown, it must be removed as follows:

1. Turn the vehicle off.
2. Disconnect the negative battery cable.
3. Remove the fuse panel cover by pressing the tab and pulling it up.
4. Remove the nuts shown in the picture above.
5. Replace the fuse with a new one of the same rating.
6. Reinstall in the reverse order of removal.

If the multi fuse is blown, we recommend that you consult an authorized HYUNDAI dealer.

## Fuse/relay panel description

### Inner fuse panel



Inside the fuse/relay panel covers, you can find the fuse/relay label describing fuse/relay name and capacity.

## **i** Information

Not all fuse panel descriptions in this manual may be applicable to your vehicle. It is accurate at the time of printing. When you inspect the fuse panel in your vehicle, refer to the fuse panel label.



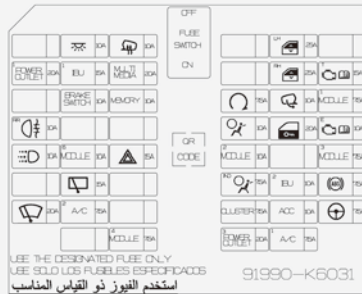





#### ■ ICU











#### ■ PCB



## Inner Compartment Fuse Panel (ICU)



Fuse Name	Symbol	Fuse rating	Circuit Protected
ROOM LAMP		10A	ICU: Room Lamp, FOOT LP_DRV & PASS, Luggage Lamp
OUTSIDE MIRROR HEATED		10A	Outside Mirror Heated, ECU, RR HTD SW
POWER WINDOW LH	<sup>LH</sup> 	25A	FRT Power Window LH
POWER OUTLET FRONT	<sup>FRT</sup> POWER OUTLET	20A	ICU/PCB: Front Power Outlet
IBU1	<sup>1</sup> IBU	15A	ICU: BODY CONTROL MODULE (IBU)
MULTI MEDIA	MULTI MEDIA	20A	ICU: AUDIO
POWER WINDOW RH	<sup>RH</sup> 	25A	FRT Power Window RH
TCU	<sup>T</sup> 	15A	PCB/ICU: AT : Speed Sensor Out, Inhibit SW.
BRAKE SWITCH	BRAKE SWITCH	10A	PCB/ICU: Stop Switch
MEMORY	MEMORY	10A	ICU: A/Con (FATC), A/Con (MTC), Cluster
START		7.5A	PCB: Inhibitor Switch, Start Relay
FOLDING MIRROR		10A	ICU/PCB: Folding Mirror
MODULE1	<sup>1</sup> MODULE	7.5A	ICU/PCB: Stop Switch
Airbag		10A	ICU/PCB: ACU

### Inner Compartment Fuse Panel (ICU)











Fuse Name	Symbol	Fuse rating	Circuit Protected
DOOR LOCK		20A	ICU: Door Lock, T/GATE
ECU	<sup>E</sup> 	10A	ICU/PCB: ECU, A_FLOW_SNSR
DRL		10A	ICU: DRL , DRL Position Lamp
MODULE6	<sup>6</sup> MODULE	10A	ICU: OBD PCB: OBD_EXTN
HAZARD		15A	PCB: HAZARD Switch, ICU: IBU (Turn Signal)
MODULE2	<sup>2</sup> MODULE	10A	PCB: ESC Switch, ICU: BCM(IBU) *for CNG:CNG_SW:IGN1
MODULE3	<sup>3</sup> MODULE	7.5A	PCB/ICU: FATC, AT Lever Indicator, Head Lamp Projection, Audio Compact, AVN, VDMS EXTN, OBD
REAR WIPER		15A	RR WPR MOTOR MFSW (RR_WIPER)
Airbag INDICATOR	<sup>IND</sup> 	7.5A	PCB/ICU: Cluster
IBU2	<sup>2</sup> IBU	10A	ICU: BCM (IBU), Immobilizer
ABS		7.5A	PCB/ICU: ABS/ESC Unit
FRONT WIPER		20A	PCB/ICU: MFSW, Wiper Motor
A/CON2	<sup>2</sup> A/C	7.5A	PCB/ICU: MTC, FATC, Dual Switch
CLUSTER	CLUSTER	7.5A	PCB/ICU: Cluster
ACC	ACC	10A	ICU: AUDIO, AVN, IBU, OBD, E_CALL, O/S MIRROR SW, USB CHARGER PCB: AUDIO, AVN, USB CHARGER, O/S MIRROR SW













### Inner Compartment Fuse Panel (ICU)

Fuse Name	Symbol	Fuse rating	Circuit Protected
MDPS		7.5A	PCB/ICU: Motor Driven Power Steering Unit
MODULE4	<sup>4</sup> MODULE	7.5A	ICU: BCM (IBU)
REAR POWER OUTLEt	<sup>RR</sup> POWER OUTLET	20A	PCB/ICU: RR Power Outlet
A/CON1	<sup>1</sup> A/C	7.5A	PCB/ICU: FATC, Blower Motor
Fog Lamp	<sup>RR</sup> 	10A	PCB/ICU: Fog Lamp REAR

### Inner Compartment Fuse Panel (ICU)

Fuse Name	Symbol	Fuse rating	Circuit Protected
TAIL LH	<sup>LH</sup> 	7.5A	PCB: Position Lamp LH, Head Lamp LH, RR Combi Lamp LH
OUTSIDE MIRROR HEATED		10A	Outside Mirror Heated
POWER WINDOW LH	<sup>LH</sup> 	25A	FOR ALL THE POWER WINDOW
POWER OUTLET FRONT	<sup>FRT</sup> <b>POWER OUTLET</b>	20A	ICU/PCB: Front Power Outlet
TAIL RH	<sup>RH</sup> 	7.5A	PCB: Position Lamp RH, Head Lamp RH, RR Combi Lamp RH
POWER WINDOW RH	<sup>RH</sup> 	25A	FRT Power Window RH
TCU	<sup>T</sup> 	15A	PCB/ICU: AT : Speed Sensor Out, Inhibit SW AMT: AMT Lever.
BRAKE SWITCH	<b>BRAKE SWITCH</b>	10A	PCB/ICU: Stop Switch
STOP LAMP	<b>STOP LAMP</b>	15A	PCB: Stop Lamp, RR Combi Lamp, HMSL
START		7.5A	PCB: Inhibitor Switch, Start Relay
FOLDING MIRROR		10A	ICU/PCB: Folding Mirror
MODULE1	<sup>1</sup> <b>MODULE</b>	7.5A	ICU/PCB: Stop Switch
IMMOBILIZER		10A	PCB: Immobilizer Unit
Airbag		10A	ICU/PCB: ACU

### Inner Compartment Fuse Panel (PCB)

Fuse Name	Symbol	Fuse rating	Circuit Protected
DOOR LOCK		20A	ICU: Door Lock
ECU	<sup>E</sup> 	10A	ICU/PCB: ECU, A_FLOW_SNSR
MODULE6	<sup>6</sup> MODULE	10A	ICU: OBD PCB: OBD & OBD_EXN
HAZARD		15A	PCB: HAZARD Switch, ICU: IBU (Turn Signal)
MODULE2	<sup>2</sup> MODULE	10A	PCB: ESC Switch, ICU: BCM (IBU)
MODULE3	<sup>3</sup> MODULE	7.5A	PCB/ICU: FATC, AT Lever Indicator, Head Lamp Projection, Audio Compact, Infotainment system
HEAD LAMP	■ Type A 	10A	PCB: Head Lamp Relay
	■ Type B 		
REAR WIPER		15A	PCB: RR Wiper Motor, ICU : Washer Motor
Airbag INDICATOR	<sup>IND</sup> 	7.5A	PCB/ICU: Cluster
TURN SIGNAL		10A	PCB: TURN SIGNAL
ABS		7.5A	PCB/ICU: ABS/ESC Unit
FRONT WIPER		20A	PCB/ICU: MFSW, Wiper Motor
A/CON2	<sup>2</sup> A/C	7.5A	PCB/ICU: MTC, FATC, Dual Switch

**Inner Compartment Fuse Panel (PCB)**

Fuse Name	Symbol	Fuse rating	Circuit Protected
CLUSTER	<b>CLUSTER</b>	7.5A	PCB/ICU: Cluster
ACC	<b>ACC</b>	10A	PCB/ICU: Crash_VDMS_Extension, USB Charger, Audio_B, IBU
MDPS		7.5A	PCB/ICU: Motor Driven Power Steering Unit.
MODULE5	<sup>5</sup> MODULE	10A	PCB/ICU: Crash_VDMS_Extension
REAR POWER OUTLET	<sup>RR</sup> POWER OUTLET	20A	PCB/ICU: RR Power Outlet
A/CON1	<sup>1</sup> A/C	7.5A	PCB/ICU: FATC, Blower Motor

## Engine compartment fuse panel

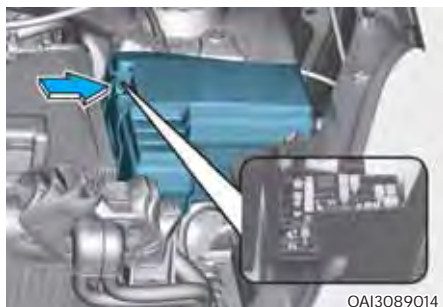

OAI3089014

Inside the fuse/relay panel covers, you can find the fuse/relay label describing fuse/relay name and capacity.





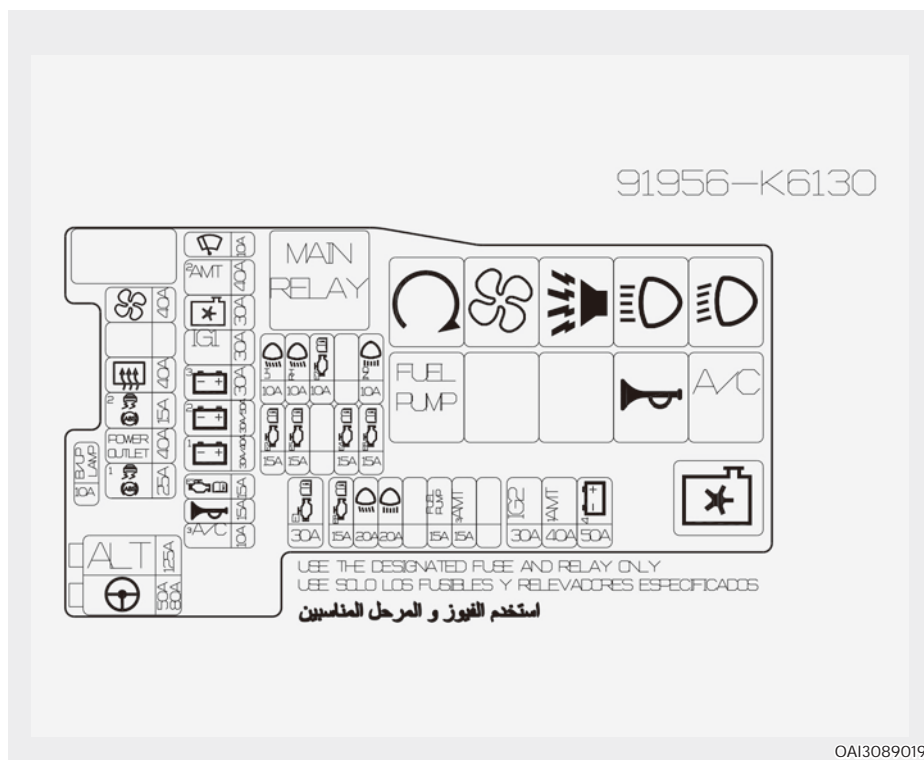





## **i** Information

Not all fuse panel descriptions in this manual may be applicable to your vehicle. It is accurate at the time of printing. When you inspect the fuse panel in your vehicle, refer to the fuse panel label.

















OAI3089019













**Engine Compartment Fuse Panel**

Item	Fuse Name	Symbol	Fuse Rating	Circuit Protected
RELAY	MAIN RELAY	<b>MAIN RELAY</b>	30A	ECU (MT, AT, CNG, BS6)
	START		20A	ECU, Start Solenoid
	BLOWER		35A	PCB, ICU
	BURGLAR ALARM HORN		20A	IBU
	HEAD LAMP HI	■ Type A 	20A	Head Lamp Projection, Head Lamp
		■ Type B 		
	HEAD LAMP LOW	■ Type A 	20A	Head Lamp Fuse
		■ Type B 		
	FUEL PUMP	<b>FUEL PUMP</b>	20A	F_PUMP_MTR
	HORN		20A	HORN
AIR CONDITIONER	<b>A/C</b>	20A	A/CON_COM	
COOLING FAN		35A	Radiator Fan Motor	
MULTI FUSE	ALTERNATOR	<b>ALT</b>	125A	K1.0, K1.2
	MDPS		80A 50A	DC type Economical type

## Engine Compartment Fuse Panel

Item	Fuse Name	Symbol	Fuse Rating	Circuit Protected
LP S/B J FUSE	BLOWER		40A	Blower Relay
	REAR HEATED		40A	RR Heated Relay
	COOLING FAN		GSL 30A	Cooling Fan Relay
	IGNITION1	<b>IG1</b>	30A	Starting (ICU/PCB_IG1)
	BATTERY3	<sup>3</sup> 	30A	ICU/PCB_B+3
LP S/B J FUSE	BATTERY2	<sup>2</sup> 	30A/50A	ICU/PCB_B+2
	BATTERY1	<sup>1</sup> 	30A/40A	ICU/PCB_B+1
	BATTERY4		50A	ICU/PCB_B+4
	AMT1	<b>AMT</b>	40A	TCU
S/B M FUSE	ABS/ESC2	<sup>2</sup> 	15A	ABS/ESC Unit
	POWER OUTLET	<b>POWER OUTLET</b>	40A	P/OUTLET RLY
	ABS/ESC1	<sup>1</sup> 	25A	ABS/ESC Unit
	ECU1	<sup>E1</sup> 	30A	FOR ALL THE ECU
	IGNITION2	<b>IG2</b>	30A	Starting, Start Relay
	AMT2	<b>AMT</b>	40A	TCU
LP MINI FUSE	BACK UP LAMP1	<sup>1</sup> B/UP LAMP	10A	BACK_UP_LAMP
	FRONT WIPER		10A	Front Wiper, ECU
	ECU3	<sup>E3</sup> 	15A	ECU (MT, AT, BS6)
	HORN		15A	Horn Relay
	AIR CONDITIONER	<b>A/C</b>	10A	A/Con Relay
	HEAD LAMP LH	<sup>LH</sup> 	10A	Head Lamp LH, Head Lamp Projection LH

**Engine Compartment Fuse Panel**

Item	Fuse Name	Symbol	Fuse Rating	Circuit Protected
LP MINI FUSE	HEAD LAMP RH		10A	Head Lamp RH, Head Lamp Projection RH
	ECU7		10A	ECU: K 1.2 CNG
	ECU8		15A	ECU: K 1.0 KMP, K 1.2 MPI
	HEAD LAMP HI		10A	Cluster
	ECU2		15A	OBD
	ECU5		15A	ECU: K 1.2 CNG
	ECU4		15A	OBD
	ECU6		15A	Ignition Coil Extension
	HEAD LAMP LO	 ■ Type A	20A	Head Lamp Relay
		 ■ Type B		
	HEAD LAMP HI	 ■ Type A	20A	Head Lamp HI Relay
		 ■ Type B		
	FUEL PUMP3		15A	Fuel Pump Relay
AMT3	<b>AMT</b>	15A	TCU	



## LIGHT BULBS

We recommend that you consult an authorized HYUNDAI dealer to replace most vehicle light bulbs. It is difficult to replace vehicle light bulbs because other parts of the vehicle must be removed before you can get to the bulb. This is especially true for removing the headlight assembly to get to the bulb(s).

Removing/installing the headlight assembly can result in damage to the vehicle.



### WARNING

Prior to replacing a light, depress the foot brake, move the shift lever into the N (Neutral, for Automatic transmission vehicle) or neutral (for manual transmission vehicle), apply the parking brake, place the ignition switch in the LOCK/OFF position, and take the key with you when leaving the vehicle to avoid sudden movement of the vehicle and to prevent possible electric shock.

Be aware the bulbs may be hot and may burn your fingers.

### NOTICE

Be sure to replace the burned-out bulb with one of the same wattage rating. Otherwise, it may cause damage to the fuse or electric wiring system.



### Information

The headlight and tail lamp lenses could appear frosty if the vehicle is washed after driving or the vehicle is driven at night in wet weather. This condition is caused by temperature difference between the lamp inside and outside and, it does not indicate a problem with your vehicle. When moisture condenses in the lamp, it will be removed after driving with the headlight on. The removable level may differ depending on lamp size, lamp position and environmental condition. However, if moisture is not removed, we recommend that your vehicle is inspected by an authorized HYUNDAI dealer.

## Headlight, Parking (Position) Light, Turn Signal Light, Daytime Running Light bulb replacement



- (1) Headlight (Low/High) \*1
- (2) Parking (Position) Light
- (3) Turn Signal Light
- (4) Daytime Running Light (if equipped) or Daytime Running Light/Position light (if equipped)

\*1 : MFR (Multi Focus Reflector) Headlight

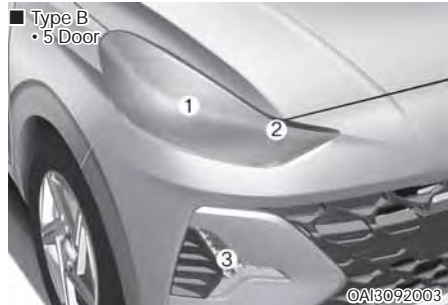

- (1) Headlight (Low/High) \*2
- (2) Turn Signal Light
- (3) Parking (Position) Light/Daytime Running Light (if equipped)

\*2 : Bi-Function Projection Headlight



## WARNING

### Halogen bulbs

- Halogen bulbs contain pressurized gas that will produce flying pieces of glass if broken.
- Always handle them carefully, and avoid scratches and abrasions. If the bulbs are lit, avoid contact with liquids. Never touch the glass with bare hands. Residual oil may cause the bulb to overheat and burst when lit. A bulb should be operated only when installed in a headlight.
- If a bulb becomes damaged or cracked, replace it immediately and carefully dispose of it.
- Wear eye protection when changing a bulb. Allow the bulb to cool down before handling it.

## Information

If the headlight aiming adjustment is necessary after the headlight assembly is reinstalled, consult an authorized HYUNDAI dealer.

## Headlight (Low/High)

### ■ Type A

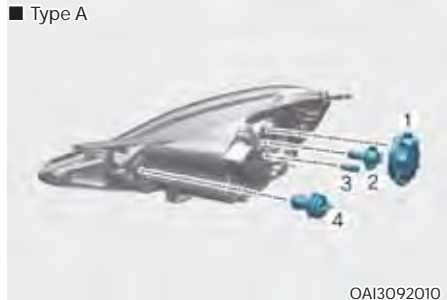

### ■ Type B

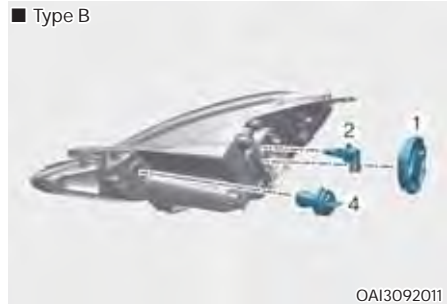

- [1]: Dust cover  
[2]: Headlight  
[3]: Parking (Position) light  
[4]: Turn signal light

1. Open the hood.
2. Disconnect the negative terminal of the battery.
3. Remove the headlight bulb cover by turning it counterclockwise.
4. Disconnect the headlight bulb socket-connector.
5. Unsnap the headlight bulb retaining wire by depressing the end and pushing it upward.
6. Remove the bulb from the headlight assembly.
7. Install a new headlight bulb and snap the headlight bulb retaining wire into position by aligning the wire with the groove on the bulb.
8. Connect the headlight bulb socket connector.
9. Install the headlight bulb cover by turning it clockwise.
10. Connect the negative terminal of the battery.

**i** Information

**- Bi-Function projection headlight**

**This headlight is bi-function type that switches the low beam to high or the high beam to low using solenoid system. So, the moving sound may be heard when the headlight switches the low beam to high or the high beam to low and it does not indicate malfunction of the headlight.**

**Turn signal light**

1. Open the hood.
2. Disconnect the negative terminal of the battery.
3. Remove the turn signal light bulb cover by turning it counterclockwise.
4. Remove the socket from the assembly by turning the socket counterclockwise until the tabs on the socket align with the slots on the assembly.
5. Insert a new bulb by inserting it into the socket and rotating it until it locks into place.
6. Install the socket in the assembly by aligning the tabs on the socket with the slots in the assembly. Push the socket into the assembly and turn the socket clockwise.
7. Install the turn signal light bulb cover by turning it clockwise.
8. Connect the negative terminal of the battery

**Parking (Position) light**

1. Remove the socket from the assembly by pulling it straight out.
2. Remove the bulb from the socket by pulling it out.
3. Insert a new bulb by inserting it into the socket.
4. Install the socket in the assembly by pushing it in.

***Parking(Position) light/  
Daytime running light  
(LED Type, If equipped)***

Your vehicle is equipped with LED lamps. LED lamps do not have replaceable bulbs. If the LED lamp does not operate, we recommend that the vehicle be checked by an authorized HYUNDAI dealer.

**NOTICE**

**We recommend that the headlamp bulb replacement be serviced by an authorized HYUNDAI dealer.**

## Side repeater light replacement (if equipped)

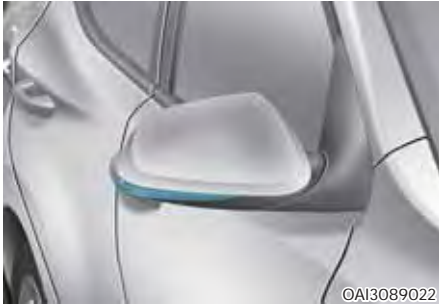

### *Type A*

If the LED lamp does not operate, we recommend that the vehicle be checked by an authorized HYUNDAI dealer.



### *Type B*

1. Disconnect the negative terminal of the battery.
2. Remove the lamp assembly from the vehicle by prying the lens and pulling the assembly out.
3. Disconnect the bulb electrical connector.
4. Separate the socket and the lens parts by turning the socket counterclockwise until the tabs on the socket align with the slots on the lens part.
5. Remove the bulb by pulling it straight out.
6. Insert a new bulb in the socket.
7. Reassemble the socket and the lens part.
8. Connect the bulb electrical connector.
9. Reinstall the lamp assembly to the body of the vehicle.
10. Connect the negative terminal of the battery

If the light does not operate, we recommend that the vehicle be checked by an authorized HYUNDAI dealer.

## Rear combination light bulb replacement



### 5 Door

1. Back Up Light
2. Rear Turn Signal Light
3. Stop Light
4. Tail light
5. Reflex Reflector

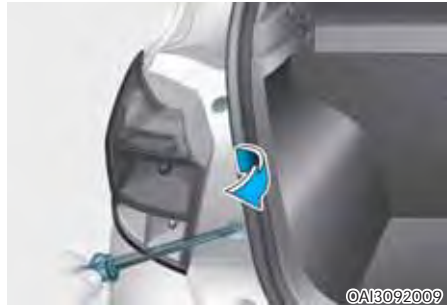

1. Open the tailgate
2. Loosen the light assembly retaining screws with a cross-tip screwdriver.
3. Remove the rear combination light assembly from the body of the vehicle.

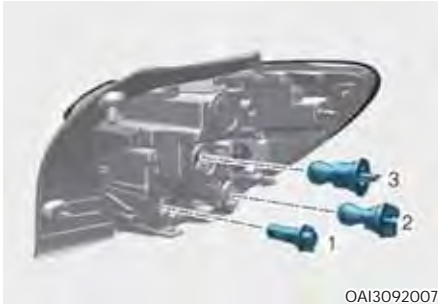

OAI3092007

- [1]: Back up light
- [2]: Rear turn signal light
- [3]: Stop light

4. Remove the socket from the assembly by turning the socket counterclockwise until the tabs on the socket align with the slots on the assembly.
5. Remove the bulb from the socket by pressing it in and rotating it counterclockwise until the tabs on the bulb align with the slots in the socket. Pull the bulb out of the socket.
6. Insert a new bulb by inserting it into the socket and rotating it until it locks into place.
7. Install the socket in the assembly by aligning the tabs on the socket with the slots in the assembly. Push the socket into the assembly and turn the socket clockwise.
8. Reinstall the light assembly to the body of the vehicle.



OAI3089065

#### **4 Door**

1. Back Up Light
2. Rear Turn Signal Light
3. Stop Light
4. Tail Light
5. Reflex Reflector

■ Outside lamp

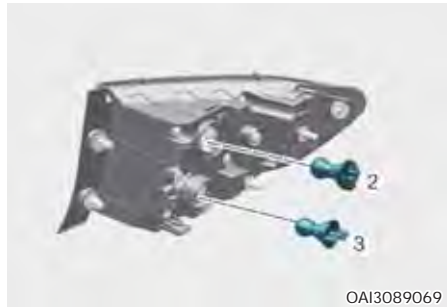

1. Open the trunk.
2. Loosen the light assembly retaining screws with a cross-tip screwdriver. Remove the rear combination light assembly from the body of the vehicle.

- [1]: Back up light  
 [2]: Rear turn signal light  
 [3]: Stop light

3. Remove the socket from the assembly by turning the socket counterclockwise until the tabs on the socket align with the slots on the assembly.
4. Remove the bulb from the socket by pressing it in and rotating it counterclockwise until the tabs on the bulb align with the slots in the socket. Pull the bulb out of the socket.
5. Insert a new bulb by inserting it into the socket and rotating it until it locks into place.

■ Inside lamp



1. Open the trunk.
2. Loosen the retaining screw of the trunk lid cover and then remove the cover.



6. Install the socket in the assembly by aligning the tabs on the socket with the slots in the assembly. Push the socket into the assembly and turn the socket clockwise.
7. Reinstall the light assembly to the body of the vehicle.

### Tail lamp (LED Type)

If the LED lamp does not operate, we recommend that the vehicle be checked by an authorized HYUNDAI dealer.

### High mounted stop light

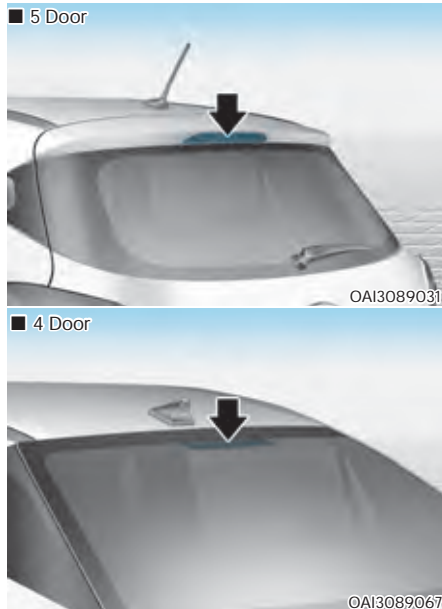

If the light does not operate, we recommend that the vehicle be checked by an authorized HYUNDAI dealer.

### License plate light bulb replacement

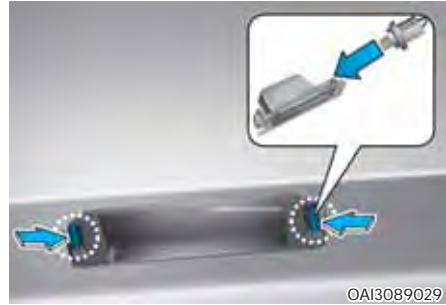

1. Using a flat-blade screwdriver, remove the light assembly from the body of the vehicle by prying the housing and pulling the assembly out.
2. Separate the socket and the lens part by turning the socket counterclockwise until the tabs on the socket align with the slots on the lens part.
3. Remove the bulb by pulling it straight out.
4. Insert a new bulb in the socket.
5. Reassemble the socket and the housing part.
6. Reinstall the light assembly to the body of the vehicle.

## Interior light bulb replacement

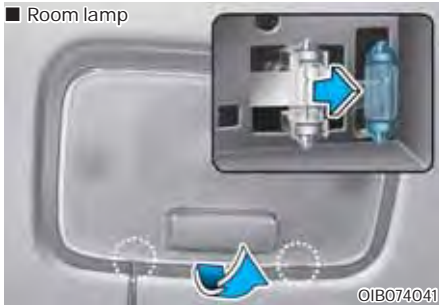

### **NOTICE**

Be careful not to dirty or damage lens, lens tab, and plastic housings.

1. Using a flat-blade screwdriver, gently pry the lens from the interior light housing.
2. Remove the bulb by pulling it straight out.
3. Install a new bulb in the socket.
4. Align the lens tabs with the interior light housing notches and snap the lens into place

## APPEARANCE CARE

### NOTICE

If you park your vehicle near a stainless steel sign or glass facade building, the vehicle's exterior plastic parts such as a bumper, spoiler, garnish, lamp or outside rearview mirror might be damaged due to sunlight reflected from the sign or building. To prevent damage of the exterior plastic parts, you should avoid parking in areas where light may be reflected or use a car cover. (The exterior plastic parts applied to your vehicle may vary.)

### Exterior care

#### *Exterior general caution*

It is very important to follow the label directions when using any chemical cleaner or polish. Read all warning and caution statements that appear on the label.

#### *High-pressure washing*

- When using high-pressure washers, make sure to maintain sufficient distance from the vehicle.  
Insufficient clearance or excessive pressure can lead to component damage or water penetration.
- Do not spray the camera, sensors or its surrounding area directly with a high pressure washer. Shock applied from high pressure water may cause the device to not operate normally.
- Do not bring the nozzle tip close to boots (rubber or plastic covers) or connectors as they may be damaged if they come into contact with high pressure water.

### *Finish maintenance*

#### **Washing**

To help protect your vehicle's finish from rust and deterioration, wash it thoroughly and frequently at least once a month with lukewarm or cold water.

If you use your vehicle for off-road driving, you should wash it after each off-road trip. Pay special attention to the removal of any accumulation of salt, dirt, mud, and other foreign materials. Make sure the drain holes in the lower edges of the doors and rocker panels are kept clear and clean.

Insects, tar, tree sap, bird droppings, industrial pollution and similar deposits can damage your vehicle's finish if not removed immediately.

Even prompt washing with plain water may not completely remove all these deposits. A mild soap, safe for use on painted surfaces, may be used.

After washing, rinse the vehicle thoroughly with lukewarm or cold water. Do not allow soap to dry on the finish.

### NOTICE

- **Do not use strong soap, chemical detergents or hot water, and do not wash the vehicle in direct sunlight or when the body of the vehicle is warm.**
- **Be careful when washing the side windows of your vehicle.**  
Especially, with high-pressure water, water may leak through the windows and wet the interior.
- **To prevent damage to the plastic parts and lamps, do not clean with chemical solvents or strong detergents.**

**⚠ WARNING**

**Wet brakes**

After washing the vehicle, test the brakes while driving slowly to see if they have been affected by water. If the braking performance is impaired, dry the brakes by applying them lightly while maintaining a slow forward speed.



**NOTICE**

- Water washing in the engine compartment including high pressure water washing may cause the failure of electrical circuits located in the engine compartment.
- Never allow water or other liquids to come in contact with electrical/electronic components inside the vehicle as this may damage them.

**NOTICE**

**Matte paint finish vehicle (if equipped)**

Automatic car wash which uses rotating brushes should not be used as this can damage the surface of your vehicle. A steam cleaner which washes the vehicle surface at high temperature may result the oil to adhere and leave stains that is difficult to remove.

Use a soft cloth (for example, microfiber towel or sponge) when washing your vehicle and dry with a microfiber towel. When you hand wash your vehicle, you should not use a cleaner that finishes with wax. If the vehicle surface is too dirty (sand, dirt, dust, contaminant, etc.), clean the surface with water before washing the car.

**Waxing**

Wax the vehicle when water will no longer bead on the paint.

Always wash and dry the vehicle before waxing. Use a good quality liquid or paste wax, and follow the manufacturer's instructions. Wax all metal trim to protect it and to maintain its luster.

Removing oil, tar, and similar materials with a spot remover will usually strip the wax from the finish. Be sure to re-wax these areas even if the rest of the vehicle does not yet need waxing.

**NOTICE**

- Wiping dust or dirt off the body with a dry cloth will scratch the finish.
- Do not use steel wool, abrasive cleaners, or strong detergents containing highly alkaline or caustic agents on chrome-plated or anodized aluminum parts. This may result in damage to the protective coating and cause discoloration or paint deterioration.

**NOTICE**

Matte paint finish vehicle  
(if equipped)

Do not use any polish protector such as a detergent, an abrasive and a polish. In case wax is applied, remove the wax immediately using a silicon remover and if any tar or tar contaminant is on the surface use a tar remover to clean. However, be careful not to apply too much pressure on the painted area.

**Finish damage repair**

Deep scratches or stone chips in the painted surface must be repaired promptly. Exposed metal will quickly rust and may develop into a major repair expense.

**i Information**

**If your vehicle is damaged and requires any metal repair or replacement, be sure the body shop applies anti-corrosion materials to the parts repaired or replaced.**

**NOTICE**

Matte paint finish vehicle  
(if equipped)

In case of matte paint finish vehicles, it is impossible to modify only the damaged area and repair of the whole part is necessary. If the vehicle is damaged and painting is required, we recommend that you have your vehicle maintained and repaired by an authorized HYUNDAI dealer. Take extreme care, as it is difficult to restore the quality after the repair.

### ***Bright-metal maintenance***

- To remove road tar and insects, use a tar remover, not a scraper or other sharp object.
- To protect the surfaces of bright-metal parts from corrosion, apply a coating of wax or chrome preservative and rub to a high luster.
- During winter weather or in coastal areas, cover the bright metal parts with a heavier coating of wax or preservative. If necessary, coat the parts with non-corrosive petroleum jelly or other protective compound.

### ***Underbody maintenance***

Corrosive materials used for ice and snow removal and dust control may collect on the underbody. If these materials are not removed, accelerated rusting can occur on the underbody parts such as the fuel lines, frame, floor pan and exhaust system, even though they have been treated with rust protection.

Thoroughly flush the vehicle underbody and wheel openings with lukewarm or cold water once a month, after off-road driving and at the end of each winter. Pay special attention to these areas because it is difficult to see all the mud and dirt. It will do more harm than good to wet down the road grime without removing it. The lower edges of the doors, rocker panels, and frame members have drain holes that should not clog with dirt; trapped water in these areas can cause rusting.



### **WARNING**

**After washing the vehicle, test the brakes while driving slowly to see if they have been affected by water. If the braking performance is impaired, dry the brakes by applying them lightly while maintaining a slow forward speed.**

### ***Aluminum wheel maintenance***

The aluminum wheels are coated with a clear protective finish.

- Do not use any abrasive cleaner, polishing compound, solvent, or wire brushes on aluminum wheels. They may scratch or damage the finish.
- Clean the wheel when it has cooled.
- Use only a mild soap or neutral detergent, and rinse thoroughly with water. Also, be sure to clean the wheels after driving on salted roads. This helps prevent corrosion.
- Avoid washing the wheels with high-speed car wash brushes.
- Do not use any alkaline or acid detergent. It may damage and corrode the aluminum wheels coated with a clear protective finish.

## **Corrosion protection**

### **Protecting your vehicle from corrosion**

By using the most advanced design and construction practices to combat corrosion, we produce vehicles of the highest quality. However, this is only part of the job. To achieve the long-term corrosion resistance your vehicle can deliver, the owner's cooperation and assistance is also required.

### **Common causes of corrosion**

The most common causes of corrosion on your vehicle are:

- Road salt, dirt and moisture that is allowed to accumulate underneath the vehicle.
- Removal of paint or protective coatings by stones, gravel, abrasion or minor scrapes and dents which leave unprotected metal exposed to corrosion.

### **High-corrosion areas**

If you live in an area where your vehicle is regularly exposed to corrosive materials, corrosion protection is particularly important. Some of the common causes of accelerated corrosion are road salts, dust control chemicals, ocean air and industrial pollution.

## **Moisture breeds corrosion**

Moisture creates the conditions in which corrosion is most likely to occur. For example, corrosion is accelerated by high humidity, particularly when temperatures are just above freezing. In such conditions, the corrosive material is kept in contact with the vehicle's surface by moisture that slowly evaporates.

Mud is particularly corrosive because it dries slowly and holds moisture in contact with the vehicle. Although the mud appears to be dry, it can still retain moisture and promote corrosion.

High temperatures can also accelerate corrosion of parts that are not properly ventilated so the moisture can be dispersed. For all these reasons, it is particularly important to keep your vehicle clean and free of mud or accumulations of other materials. This applies not only to the visible surfaces but particularly to the underside of the vehicle.

## **To help prevent corrosion**

You can help prevent corrosion from getting started by observing the following:

### Keep your vehicle clean

The best way to prevent corrosion is to keep your vehicle clean and free of corrosive materials. Attention to the underside of the vehicle is particularly important.

- If you live in a high-corrosion area — where road salts are used, near the ocean, areas with industrial pollution, acid rain, etc.—, you should take extra care to prevent corrosion. In winter, hose off the underside of your vehicle at least once a month and be sure to clean the underside thoroughly when winter is over.
- When cleaning underneath the vehicle, give particular attention to the components under the fenders and other areas that are hidden from view. Do a thorough job; just dampening the accumulated mud rather than washing it away will accelerate corrosion rather than prevent it. Water under high pressure and steam are particularly effective in removing accumulated mud and corrosive materials.
- When cleaning lower door panels, rocker panels and frame members, be sure that drain holes are kept open so that moisture can escape and not be trapped inside to accelerate corrosion.

### Keep your garage dry

Don't park your vehicle in a damp, poorly ventilated garage. This creates a favorable environment for corrosion. This is particularly true if you wash your vehicle in the garage or drive it into the garage when it is still wet or covered with snow, ice or mud. Even a heated garage can contribute to corrosion unless it is well ventilated so moisture is dispersed.

### Keep paint and trim in good condition

Scratches or chips in the finish should be covered with "touch-up" paint as soon as possible to reduce the possibility of corrosion. If bare metal is showing through, the attention of a qualified body and paint shop is recommended.

**Bird droppings :** Bird droppings are highly corrosive and may damage painted surfaces in just a few hours. Always remove bird droppings as soon as possible.

### Don't neglect the interior

Moisture can collect under the floor mats and carpeting and cause corrosion. Check under the mats periodically to be sure the carpeting is dry. Use particular care if you carry fertilizers, cleaning materials or chemicals in the vehicle.

These should be carried only in proper containers and any spills or leaks should be cleaned up, flushed with clean water and thoroughly dried.



## Interior care

### *Interior general precautions*

Prevent chemicals such as perfume, cosmetic oil, sun cream, hand cleaner, and air freshener from contacting the interior parts because they may cause damage or discoloration. If they do contact the interior parts, wipe them off immediately. See the instructions that follow for the proper way to clean vehicle interior surfaces.

#### **NOTICE**

- **Never allow water or other liquids to come in contact with electrical/electronic components inside the vehicle as this may damage them.**
- **When cleaning leather products (steering wheel, seats etc.), use neutral detergents or low alcohol content solutions. If you use high alcohol content solutions or acid/alkaline detergents, the color of the leather may fade or the surface may get stripped off.**
- **During window tinting, make sure window tinting solution does not flow into electronic devices inside the vehicle. It may cause breakdown and malfunction of devices.**

### *Cleaning the upholstery and interior trim*

#### **Vehicle interior surfaces (if equipped)**

Remove dust and loose dirt from interior surfaces with a whisk broom or a vacuum cleaner.

If necessary, clean interior surfaces with a mixture of warm water and mild non-detergent cleaner (test all cleaners on a concealed area before use).

#### **Fabric (if equipped)**

Remove dust and loose dirt from fabric with a whisk broom or vacuum cleaner. Clean with a mild soap solution recommended for upholstery or carpets. Remove fresh spots immediately with a fabric spot cleaner. If fresh spots do not receive immediate attention, the fabric can be stained and its color can be affected. Also, its fire-resistant properties can be reduced if the material is not properly maintained.

#### **NOTICE**

Using anything but recommended cleaners and procedures may affect the fabric's appearance and fire-resistant properties.

### **Leather (if equipped)**

- Feature of Seat Leather
  - Leather is made from the outer skin of an animal, which goes through a special process to be available for use. Since it is a natural object, each part differs in thickness or density. Wrinkles may appear as a natural result of stretching and shrinking depending on the temperature and humidity.
  - The seat is made of stretchable fabric to improve comfort.
  - The parts contacting the body are curved and the side supporting area is high which provides driving comfort and stability.
  - Wrinkles may appear naturally from usage. It is not a fault of the products.



### **CAUTION**

- Wrinkles or abrasions which appear naturally from usage are not covered by warranty.
  - Belts with metallic accessories, zippers or keys inside the back pocket may damage the seat fabric.
  - Make sure not to wet the seat. It may change the nature of natural leather.
  - Jeans or clothes which could bleach may contaminate the surface of the seat covering fabric.
- Caring for the leather seats
    - Vacuum the seat periodically to remove dust and sand on the seat. It will prevent abrasion or damage of the leather and maintain its quality.
    - Wipe the natural leather seat cover often with dry or soft cloth.
    - Use of proper leather protective may prevent abrasion of the cover and helps maintain the color. Be sure to read the instructions and consult a specialist when using leather coating or protective agent.
    - Light colored (beige, cream beige) leather is easily contaminated and the stain is noticeable. Clean the seats frequently.
    - Avoid wiping with wet cloth. It may cause the surface to crack.

- Cleaning the leather seats
  - Remove all contaminations instantly. Refer to instructions below for removal of each contaminant.
  - Cosmetic products (sunscreen, foundation, etc.)

Apply cleansing cream on a cloth and wipe the contaminate spot. Wipe off the cream with a wet cloth and remove water with a dry cloth.
  - Beverages (coffee, soft drink, etc.)

Apply a small amount of neutral detergent and wipe until contaminations do not smear.
  - Oil  
Remove oil instantly with absorbable cloth and wipe with stain remover used only for natural leather.
  - Chewing gum  
Harden the gum with ice and remove gradually.

### ***Cleaning the lap/shoulder belt webbing***

Clean the belt webbing with any mild soap solution recommended for cleaning upholstery or carpet. Follow the instructions provided with the soap. Do not bleach or re-dye the webbing because this may weaken it.

### ***Cleaning the interior window glass***

If the interior glass surfaces of the vehicle become fogged (that is, covered with an oily, greasy or waxy film), they should be cleaned with glass cleaner. Follow the directions on the glass cleaner container.

### **NOTICE**

**Do not scrape or scratch the inside of the rear window. This may result in damage to the rear window defroster grid.**

## EMISSION CONTROL SYSTEM

The emission control system of your vehicle is covered by a written limited warranty. Please see the warranty information contained in the Service Passport in your vehicle.

Your vehicle is equipped with an emission control system to meet all emission regulations.

There are three emission control systems which are as follows.

- (1) Crankcase emission control system
- (2) Evaporative emission control system
- (3) Exhaust emission control system

In order to assure the proper function of the emission control systems, it is recommended that you have your car inspected and maintained by an authorized HYUNDAI dealer in accordance with the maintenance schedule in this manual.

### 1. Crankcase emission control system

The positive crankcase ventilation system is employed to prevent air pollution caused by blow-by gases being emitted from the crankcase. This system supplies fresh filtered air to the crankcase through the air intake hose. Inside the crankcase, the fresh air mixes with blow-by gases, which then pass through the PCV valve into the induction system.

### 2. Evaporative emission control system

The Evaporative Emission Control System is designed to prevent fuel vapors from escaping into the atmosphere.

#### *Canister*

Fuel vapors generated inside the fuel tank are absorbed and stored in the onboard canister. When the engine is running, the fuel vapors absorbed in the canister are drawn into the surge tank through the purge control solenoid valve.

#### *Purge Control Solenoid Valve (PCSV)*

The purge control solenoid valve is controlled by the Engine Control Module (ECM); when the engine coolant temperature is low during idling, the PCSV closes so that evaporated fuel is not taken into the engine. After the engine warms up during ordinary driving, the PCSV opens to introduce evaporated fuel to the engine.

### 3. Exhaust emission control system

The Exhaust Emission Control System is a highly effective system which controls exhaust emissions while maintaining good vehicle performance.

#### ***Engine exhaust gas precautions (carbon monoxide)***

- Carbon monoxide can be present with other exhaust fumes. Therefore, if you smell exhaust fumes of any kind inside your vehicle, have it inspected and repaired immediately. If you ever suspect exhaust fumes are coming into your vehicle, drive it only with all the windows fully open. Have your vehicle checked and repaired immediately.



#### **WARNING**

##### **Exhaust**

**Engine exhaust gases contain carbon monoxide (CO). Though colorless and odorless, it is dangerous and could be lethal if inhaled. Follow the instructions on this page to avoid CO poisoning.**

- Do not operate the engine in confined or closed areas (such as garages) any more than what is necessary to move the vehicle in or out of the area.
- When the vehicle is stopped in an open area for more than a short time with the engine running, adjust the ventilation system (as needed) to draw outside air into the vehicle.
- Never sit in a parked or stopped vehicle for any extended time with the engine running.
- When the engine stalls or fails to start, excessive attempts to restart the engine may cause damage to the emission control system.

***Operating precautions for catalytic converters (if equipped)***



**WARNING**

**Fire**

- A hot exhaust system can ignite flammable items under your vehicle. Do not park, idle, or drive the vehicle over or near flammable objects, such as grass, vegetation, paper, leaves, etc.
- The exhaust system and catalytic system are very hot while the engine is running or immediately after the engine is turned off. Keep away from the exhaust system and catalytic, you may get burned. Also, do not remove the heat sink around the exhaust system, do not seal the bottom of the vehicle or do not coat the vehicle for corrosion control. It may present a fire risk under certain conditions.

Your vehicle is equipped with a catalytic converter emission control device.

Therefore, the following precautions must be observed:

- Use only UNLEADED FUEL for gasoline engine.
- Do not operate the vehicle when there are signs of engine malfunction, such as misfire or a noticeable loss of performance.
- Do not misuse or abuse the engine. Examples of misuse are coasting with the ignition off and descending steep grades in gear with the ignition off.
- Do not operate the engine at high idle speed for extended periods (5 minutes or more).
- Do not modify or tamper with any part of the engine or emission control system. All inspections and adjustments must be made by an authorized HYUNDAI dealer.
- Avoid driving with an extremely low fuel level. Running out of fuel could cause the engine to misfire, damaging the catalytic converter.

Failure to observe these precautions could result in damage to the catalytic converter and to your vehicle.

Additionally, such actions could void your warranties.

### ***Gasoline particulate filter (GPF) (if equipped)***

Gasoline Particulate Filter (GPF) system removes the soot in the exhaust gas. The GPF system automatically burns (or oxidizes) the accumulated soot in accordance with driving situations, unlike a disposable air filter. In other words, the accumulated soot is automatically purged out by the engine control system and by the high exhaust gas temperature at normal/ high driving speeds. However, when the vehicle is continually driven at repeated short distances or driven at low speed for a long time, the accumulated soot may not be automatically removed because of low exhaust gas temperature. In this case, the accumulated soot may reach a certain amount regardless of the soot oxidization process, then the GPF lamp (  ) will illuminate. The Gasoline Particulate Filter (GPF) lamp stops illuminating, when the driving speed exceeds 80 km/h (50 mph) with engine RPM 1,500 ~ 4,000 and the gear in the 3rd position or above for approximately 30 minutes. When the GPF lamp starts to blink or the warning message "Check exhaust system" pops up even though the vehicle was driven as mentioned above, we recommend that you have the GPF system checked by an authorized HYUNDAI dealer. With GPF lamp blinking for an extended period of time, it may damage the GPF system and lower the fuel economy.



### **CAUTION**

**We recommend you to use only the regulated gasoline fuels, when your vehicle is equipped with the GPF system. When you use other gasoline fuels which contain unspecified additives, they may damage the GPF system and cause exhaust emission problems.**

